

User's Manual

E

FlexScan[®] L66

Color LCD Monitor

**Desktop Stand Type
Free Mount Type**

CONTENTS



PRECAUTIONS	4
--------------------	----------

INTRODUCTION	12
---------------------	-----------

About this Manual	12
Package Contents	12
Controls & Connectors	14

1 INSTALLATION	18
-----------------------	-----------

1-1 Connecting up	18
PC Settings	18
Connecting the cables (Desktop Stand Type)	19
Connecting the cables (Free Mount Type)	24

2 USING THE SCREENMANAGER	29
----------------------------------	-----------

2-1 How to use the ScreenManager	29
About ScreenManager	29
ScreenManager Menus	29
How to use the ScreenManager	32
Adjustment Lock	33
2-2 Screen Adjustment	34
About Screen Adjustments	34
Adjustment Procedure	36
Screen Adjustment Features	41
2-3 Color Adjustment	45
About Color Adjustments	45
Color Mode	45
Custom Color Adjustments	46
2-4 Power-save Setup	48
About PowerManager	48
Setup Procedure	49
2-5 Other Settings	53
About Other Settings	53
Screen Size	53
Border Intensity	55
Input Priority	56
Off Timer	57
Beep	59
Menu Position	60
Reset	60

3 MAKING USE OF USB	
(Desktop Stand Type Only) _____	62
4 TROUBLESHOOTING _____	65
5 CLEANING _____	69
6 SPECIFICATIONS _____	70
APPENDIX _____	i
Pin Assignment	ii
Preset Timing Chart	iii
Dimensions	vi

Copyright© 1999 by EIZO NANA O CORPORATION. All rights reserved. No part of this manual may be reproduced, stored in a retrieval system, or transmitted, in any form or by any means, electronic, mechanical, or otherwise, without the prior written permission of EIZO NANA O CORPORATION.

EIZO NANA O CORPORATION is under no obligation to hold any submitted material or information confidential unless prior arrangements are made pursuant to EIZO NANA O CORPORATION's receipt of said information.

Although every effort has been made to ensure that this manual provides up-to-date information, please note that EIZO monitor specifications are subject to change without notice.

Apple and Macintosh are trademarks of Apple Computer Inc., registered in the U.S. and other countries.
 DPMS is a trademark and VESA is a registered trademark of Video Electronics Standards Association.
 VGA is a registered trademark of International Business Machines Corporation in the USA and other countries.
 ENERGY STAR is a U.S. registered mark.
 Windows is a registered trademark of Microsoft Corporation.
 ScreenManager, PowerManager, QuickSet, i-Sound and i-Station are trademarks of EIZO NANA O CORPORATION.
 FlexScan, SuperErgoCoat and EIZO are registered trademarks of EIZO NANA O CORPORATION.

PRECAUTIONS

IMPORTANT!

* The manufacturer is not responsible for damage or malfunction caused by improper connection. The power cord should be connected directly to a standard wall power outlet.

Location of the caution statements on the back panel.

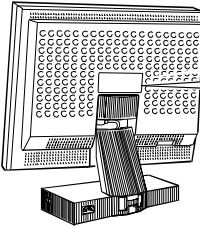

CAUTION: Risk of electric shock. Do not open.

ATTENTION: Risque de choc électrique. Ne pas ouvrir.

ACHTUNG: Gefahr des elektrischen schlages. Rückwand nicht entfernen.



The equipment must be connected to a grounded main outlet.

Jordet stikkontakt skal benyttes når apparatet tilkobles datanett.

Apparaten skall anslutas till jordat nätuttag.

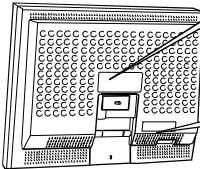

Use the included power unit only.

Nur das mitgelieferte Netzteil verwenden.

N'utiliser que l'alimentation spéciale fournie.



CAUTION: Risk of electric shock. Do not open.

ATTENTION: Risque de choc électrique. Ne pas ouvrir.

ACHTUNG: Gefahr des elektrischen schlages. Rückwand nicht entfernen.

警告： 高圧注意
サービスマン以外の方は
裏ぶたをあけないでくだ
さい。内部には高電圧部
分が数多くあり、万一さ
わると危険です。

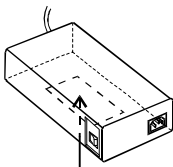

CAUTION: Risk of electric shock. Do not open.

ATTENTION: Risque de chocelectrique. Ne pas ouvrir.

ACHTUNG: Gefahr des elektrischen schlages. Rückwand nicht entfernen.



Be careful as this unit may be hot.
Do not place this unit on carpets or cover with cloth etc.

Attention, cet appareil peut chauffer.
Ne pas placer cet appareil sur des tapis ou moquettes,
et ne pas le recouvrir de vêtements ou autres objets.

Vorsicht! Das Gerät ist möglicherweise heiß.
Gerät keinesfalls auf Teppichböden stellen und nicht
mit einem Tuch o. ä. abdecken.

IMPORTANT!

To ensure personal safety and proper maintenance. Please read this section and the caution statements on the LCD monitor (refer to the figure above).

The diagrams of the LCD shown in this manual represent both the desktop stand type and the free mount type of L66 unless the type is clearly shown.

This manual uses the safety symbols below. They denote critical information. Please read them carefully.



Indicates a prohibited action.



WARNING

Failure to abide by the information in a WARNING may result in serious injury and can be life threatening.



CAUTION

Failure to abide by the information in a CAUTION may result in moderate injury and/or property or product damage.



WARNING

- **If the LCD monitor begins to emit smoke, smells like something is burning, or makes strange noises, disconnect all power connections immediately and contact your dealer for advice.**

Attempting to use a malfunctioning LCD monitor can be dangerous.

- **Do not dismantle the cabinet or modify the LCD monitor.**

Dismantling the cabinet or modifying the monitor may result in electric shock or burn.

- **Keep small objects away from the LCD monitor.**

Small objects may accidentally fall through the ventilation slots into the cabinet-leading to fire, shock or equipment damage.

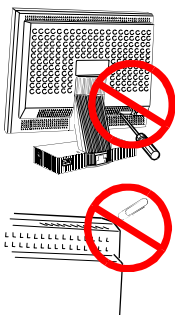



- **Keep liquids away from the LCD monitor.**

Spillage into the cabinet may result in fire, electric shock, or equipment damage.

If an object or liquid falls/spills into the cabinet, unplug the LCD monitor immediately. Have the unit checked by a qualified service engineer before using it again.

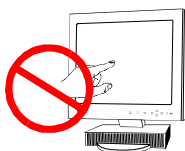

- **Do not touch a damaged LCD panel directly with bare hands.**

Use protective gloves whenever handling a damaged panel. The liquid crystal which leaks from the panel is poisonous if it enters the eyes or mouth. If any part of the skin or body comes in direct contact with the panel, please wash thoroughly. If some physical symptoms result, please consult your doctor.

- **Take care in disposing of the LCD monitor.**

The backlight of the LCD monitor contains mercury. Follow local regulations or laws for safe disposal.

- **Use the enclosed power cord and/or the power unit. Do not use the power unit with any equipment but L66 free mount type monitor.**

Failure to do so may result in fire or electric shock.

- **Use the enclosed power cord. If using the power cord other than the enclosed one, use the following cord.**

In USA and Canada:

* Rating: min. 125 V, 10 A * Length: max. 2.1 m

* Type: SVT

* Plug type: NEMA 5-15P, Parallel blade, Grounding type, 125 V, 10 A

In Europe:

* Rating: min. 250 V, 10 A * Length: max. 2.1 m

* Type: H05VV-F 3G 1 mm²

Use a plug type approved by the country where you use

Failure to do so may cause fire or electric shock.



- **The equipment must be connected to a grounded main outlet.**

Failure to do this may result in an electric shock.

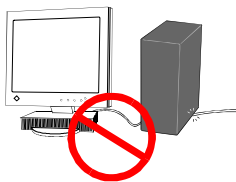

- **Handle the power cord and/or the power unit with care.**

- * Do not place the cord underneath the LCD monitor or other heavy objects.
- * Do not pull on the cord.
- * Do not bend, bundle or tie up the cord.
- * Never attempt to repair a damaged cord.

If the power cord and/or the power unit becomes damaged, stop using it. Use of a damaged cord may result in fire or electric shock.

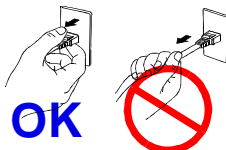

- **To disconnect the power cord, grasp the plug firmly and pull.**

Never tug on the cord, doing so may cause damage and could result in fire or electric shock.

- **Use the correct voltage.**

The LCD monitor is designed for use with a specific voltage only. Connection to a different voltage may cause fire, electric shock, or other damage.

- **Do not overload your power circuit, as this may result in fire or electric shock.**

- **To ensure proper connections of the power cord, be certain to plug the power cord into the provided LCD monitor connector and directly to a wall outlet.**

By not doing so may result in fire or electric shock.



- **Keep the plastic packing bags away from children and infants.**

Plastic bags can be dangerous. To avoid danger of suffocation, keep the bag away from babies and children.

- **Keep power terminal covers for the optional peripheral unit away from children and infants.**

Children and infants may accidentally swallow the covers and choke. If swallowed, consult a doctor immediately.

- **Place the LCD monitor on a strong, stable surface (desktop stand type only).**

A unit placed on an inadequate surface may fall, resulting in injury or equipment damage.

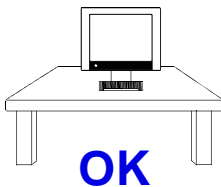

If the LCD monitor falls, disconnect the power immediately and have the unit checked by a qualified service engineer before using it again. Using a LCD monitor after it has been dropped may result in fire or electric shock.

- **Preventing from causing injury or breaking the monitor, free mount type LCD monitor must be securely attached to the appropriate mount using the bracket and the screw enclosed.**

To attach the mount to the LCD, please read the instruction manual of the mount.

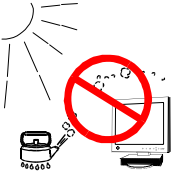

- **Set the LCD monitor in an appropriate location.**
 - * Do not install in a dusty or humid environment.
 - * Do not place near water.
 - * Do not place in a location where light shines directly on the screen.
 - * Do not place near heat generating devices or a humidifier.

CAUTION

- **At the end of the day, or if you plan to leave the LCD monitor unused for an extended period, turn off the main power switch and disconnect the power cord from the wall socket so that no power connections are made.**
- **To ensure safety, always unplug the LCD monitor before cleaning it.**

Cleaning the LCD monitor while it is plugged into a power outlet may result in electric shock.



- **Never use thinner, benzene, or other strong solvents or abrasive cleaners, as these may cause damage to the cabinet or LCD panel.**

- **Periodically clean the area around the plug.**

Build-up of dust, water, or oil on the plug may result in fire.

- **Please keep the LCD monitor in a dust-free environment.**

Dust accumulation within the LCD monitor may result in fire or equipment failure.



- **Do not touch the plug or the power unit with wet hands.**

Touching the plug with wet hands is dangerous and can cause electrical shock.

- **When handling the LCD monitor, please refer to the diagram.**

Grip the bottom of the LCD monitor firmly with both hands ensuring the panel faces outward before lifting.

OK

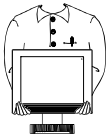

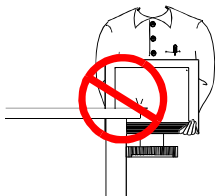

- **Handle with care to avoid scratching or damaging the panel.**

If the LCD monitor becomes damaged, disconnect the power immediately and have the unit checked by a qualified service engineer before using it again. Using a LCD monitor after it has been dropped may result in fire or electric shock.

- **Disconnect the power cord and/or the power unit when moving the LCD monitor.**

Moving the LCD monitor with the cord attached or lifting it is dangerous. It may result in injury or equipment damage.

- **When handling the power unit, do not do so by the cord (free mount type only).**

Doing so may cause damage and could result electric shock.

- **Use an easily accessible power outlet.**

This will ensure that you can disconnect the power quickly in case of a problem.

- **When handling the power unit, be careful as it may be hot (free mount type only).**

* Do not place or cover the power unit with any objects; especially carpets or cloth. Doing so may result in fire.

* Keep direct sunlight or heat generating devices such as a heater away from the power unit.

* Touching the power unit with bare hands may result in a burn.

- **Do not use the power unit hanging in midair. Place it on a solid, flat surface (free mount type only). Do not drop the power unit.**

Hanging the power unit in midair may result in fire or electric shock.

- **Do not use the LCD monitor outdoors or inside a car.**

This LCD monitor has been made specifically for indoor use as a desktop monitor. Using it anywhere else may result in fire, electrical shock, or other damage.

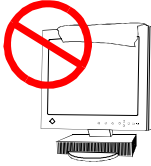

- **Do not block the ventilation slots on the cabinet.**

- * Do not place books or any other papers on the ventilation slots.
- * Do not install the monitor in a closed space.
- * Do not use the monitor laying down or upside down.
- * Do not remove the tilt-swivel stand.

Using the monitor in this way blocks the ventilation slots and prevents proper airflow, leading to fire or other damage.

Others

- **The screen may have some defective pixels. These pixels may appear as slightly light or dark areas on the screen. This is due to the characteristics of the panel itself, and not the LCD product.**

- **The backlight of the LCD monitor has a fixed life span.**

When the screen becomes dark or begins to flicker, please contact your dealer.



- **Take care when handling the LCD panel.**

- * Do not press on the panel or edge of the frame strongly as this will result in damage to the screen. There will be prints left on the screen if the pressed image is dark or black. Leave the screen white to decrease the prints.
- * Do not scratch or press on the panel with any sharp objects, such as pencil or pen as this may result in damage to the panel.
- * Cleaning the panel with a dirty or rough cloth may damage the panel.

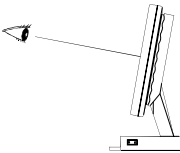

- Generally, for maximum viewing comfort position the LCD monitor slightly below eye level. Staring at the LCD monitor for prolonged periods can cause eye strain. Be sure to take adequate rests. (A 10-minute rest period each hour is suggested.)

INTRODUCTION

About This Manual

This manual explains the precautions, features, specifications, and operation of your EIZO LCD monitor. For convenience, a “ScreenManager Quick Reference” guide has been included which shows how to implement basic adjustments with the ScreenManager utility.

NOTE

- This manual applies to the EIZO monitor types: The desktop stand type and the free mount type. Please note that there are some points which vary according to the type.

Package Contents

(Desktop Stand Type):

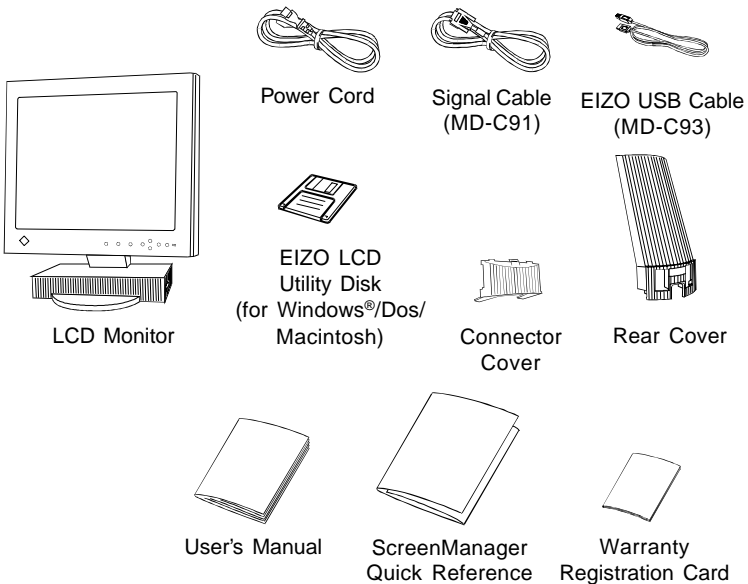

NOTE

- If any of the above-listed items are missing or damaged, please contact your local dealer for assistance.
- We recommend that you retain the original packing materials in case of future need.

Package Contents (Free Mount Type):

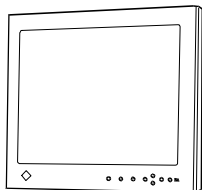

LCD Monitor

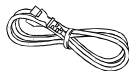

Power Cord

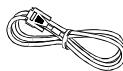

Signal Cable
(MD-C91)



Bracket



EIZO LCD
Utility Disk
(for Windows/Dos/
Macintosh)

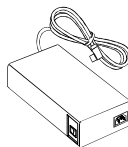

Power Unit



6 of 4 mm x 10 mm
2 of 4 mm x 30 mm
mounting screws



User's Manual



ScreenManager
Quick Reference



Warranty
Registration Card

NOTE

- If any of the above-listed items are missing or damaged, please contact your local dealer for assistance.
- We recommend that you retain the original packing materials in case of future need.

Controls & Connectors (Desktop Stand Type)

Front

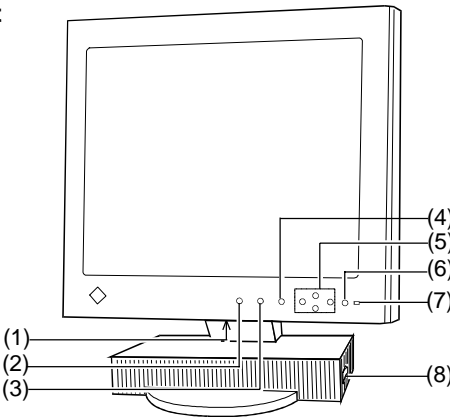

Viewing Angles

Horizontal: 140°

Vertical: 110°

(1) Power Terminal Covers for the Optional Peripheral

(2) Input Signal Selection Button

Selects one of two D-Sub connectors as the active input. This feature is only used when two computers are connected to the LCD monitor.

(3) Auto Adjustment Button

Automatically centers the displayed image.

(4) Enter Button

Used for starting the ScreenManager function and for entering adjustments and settings.

(5) Control Buttons

The four control buttons (up, down, right and left buttons) and the Enter button are used to enter adjustments and settings when using the ScreenManager menu.

(6) Power Button

This button switches the monitor's power ON and OFF only when the main power is ON. It also delays the monitor shifting from "Advance Notice Period" to "Power Off". See page 57.

(7) Power Indicator

Indicates the power-on status in the following ways:

Solid green:	Power is ON (normal mode)
Flashing green:	Power is switching off in 15 minutes (See page 57)
Flashing yellow:	Power is OFF (main power is ON)
Yellow:	Power Saving Mode

(8) Main Power Switch

Switches the LCD monitor's main power ON and OFF.

Rear

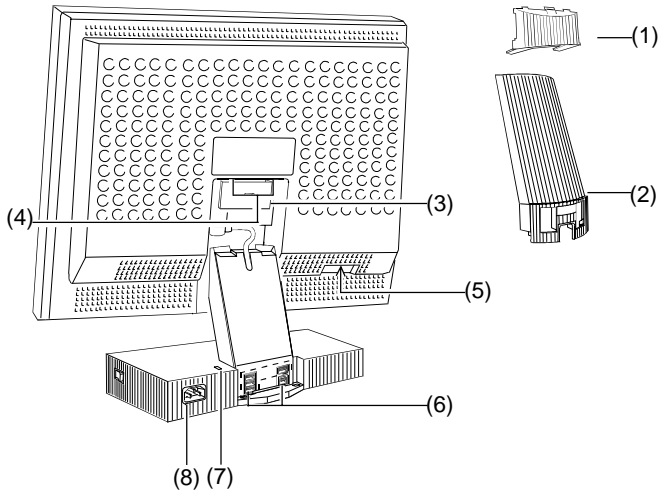

(1) Connector Cover

Remove the connector cover of the LCD monitor to connect the signal cables.

(2) Rear Cover

Remove the rear cover of the LCD monitor to connect the signal cables.

(3) D-Sub Connector Holder

Used to prevent the D-Sub signal cables from becoming loose or disconnected.

(4) 2 x D-Sub mini 15 pin Input Connectors (Input Signal 1 and 2)

(5) Maintenance Port

Service use only.

(6) USB Ports (Upstream Port x 1, Downstream Ports x 4)

See page 63 for further details.

(7) Security Lock

Allows for connection of a security cable.

This lock supports the Kensington's MicroSaver security system. For further information, please consult below.

Kensington

2855 Campus Drive, San Mateo, CA USA 94403

800-535-4242, x3348

Intl: 415-572-2700, x3348 Fax: 415-572-9675

(8) Power Connector

Use the supplied power cord only.

Controls & Connectors (Free Mount Type)

Front

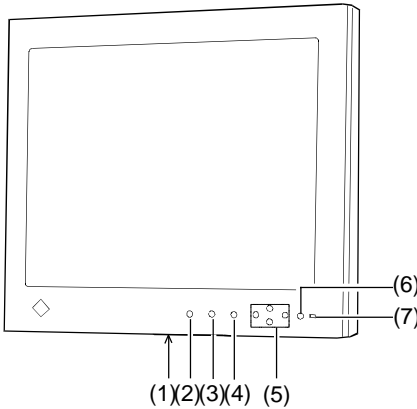

Viewing Angles

Horizontal: 140°

Vertical: 110°

- (1) Power terminal covers for the optional peripheral
- (2) Input Signal Selection Button
Selects one of two D-Sub connectors as the active input. This feature is only used when two computers are connected to the LCD monitor.
- (3) Auto Adjustment Button
Automatically centers the displayed image.
- (4) Enter Button
Used for starting the ScreenManager function and for entering adjustments and settings.
- (5) Control Buttons
The four control buttons (up, down, right and left buttons) and the Enter button are used to enter adjustments and settings when using the ScreenManager menu.
- (6) Power Button
This button switches the monitor's power ON and OFF only when the main power is ON. It also delays the monitor shifting from "Advance Notice Period" to "Power Off". See page 57.
- (7) Power Indicator
Indicates the power-on status in the following ways:
 - Solid green: Power is ON (normal mode)
 - Flashing green: Power is switching off in 15 minutes (See page 57)
 - Flashing yellow: Power is OFF (main power is ON)
 - Yellow: Power Saving Mode

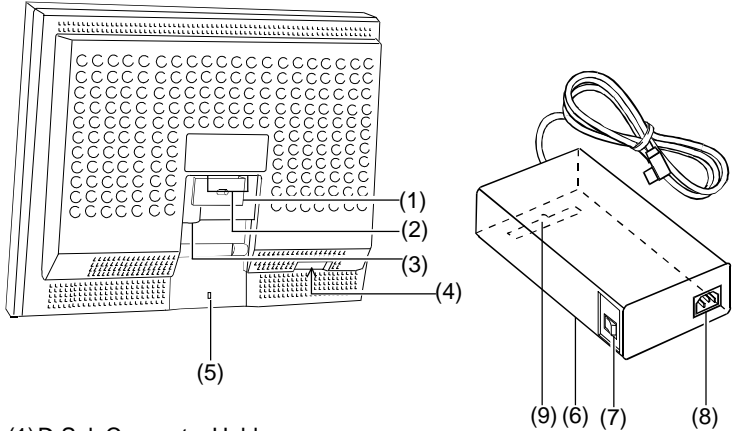

(1) D-Sub Connector Holder

Used to prevent the D-Sub signal cables from becoming loose or disconnected.

(2) 2 x D-Sub mini 15 pin Input Connectors (Input Signal 1 and 2)

(3) DC IN

Connects to the enclosed power unit.

(4) Maintenance Port

Service use only.

(5) Security Lock

Allows for connection of a security cable.

This lock supports the Kensington's MicroSaver security system. For further information, please consult below.

Kensington

2855 Campus Drive, San Mateo, CA USA 94403

800-535-4242, x3348

Intl: 415-572-2700, x3348 Fax: 415-572-9675

(6) Power Unit

(7) Main Power Switch

Switches the LCD monitor's main power ON and OFF.

(8) Power Connector

Use the supplied power cord only.

(9) Slot

1 INSTALLATION

1-1 Connecting up

Please read the appropriate pages for the LCD connection.

Desktop Stand Type : From Page 19 to 23

Free Mount Type: From Page 24 to 28

PC Settings

Before connecting your PC to the L66 LCD monitor, change the display screen settings (resolution and frequency) in accordance with those below.

fH: 30 kHz-82 kHz

fV: 50 Hz-85 Hz

NOTE

- The maximum resolution of this LCD monitor is 1280 x 1024 at a maximum fV of 75 Hz.

Using the LCD monitor with Windows® 95/98

A Monitor information file is saved in the EIZO LCD Utility Disk included in the package. It includes all the L66 required information for best operation with Windows 95/98. Please install the enclosed utility and select "EIZO L66" from the monitor list in Windows 95/98.

For installation procedure, please read the readme.txt in the utility disk.

Connecting the Cables (Desktop Stand Type)

- (1) Be sure that the power switches of both the PC and the LCD monitor are OFF.
- (2) Remove the D-Sub connector holder.
 - a) Hand-loosen the screws at the center of the holder.
 - b) Pull the holder away while squeezing both sides of the holder.

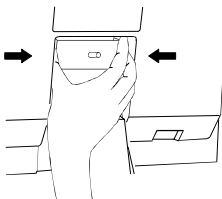

- (3) Plug the signal cable (which is marked "LCD") into the D-Sub connector (Signal 1) at the rear of the monitor. Please ensure that the arrow mark on the casing of the connector is visible when connecting. See note.

NOTE

When connecting the signal cable, check that the shape of the cable connector matches the shape on the LCD monitor.

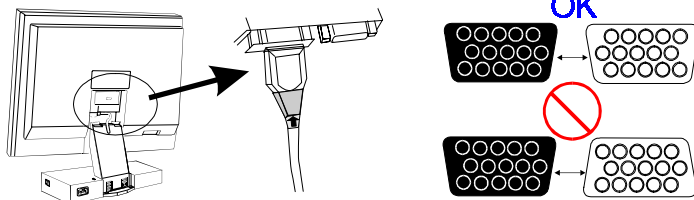

- (4) Replace the D-Sub connector holder and hand-tighten the screw.

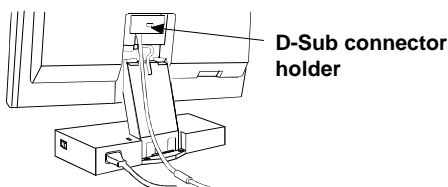

- (5) Plug the other end of the cable into the video connector on the rear of the PC.

Standard PC graphics board

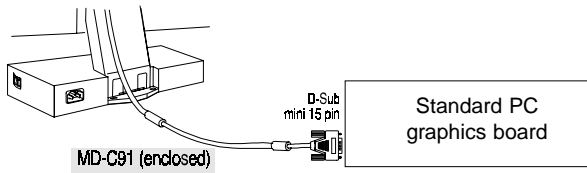

Macintosh

Please connect the optional Macintosh adapter to the PC before attaching the signal cable.

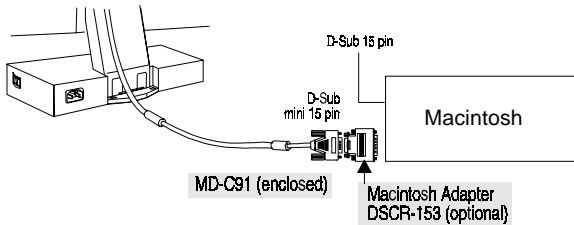

(6) Replacing the connector cover and the rear cover.

a) To close easily, the LCD monitor should be tilted forward as shown in the diagram.

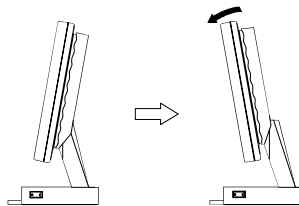

NOTE

- When tilting the panel, take care not to catch your fingers between the rear panel and the stand.
- b) Attach the connector cover to the rear panel of the LCD.



c) Insert the rear cover into the inlets at the bottom of the stand.

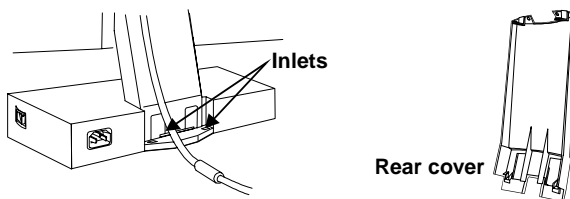

d) Close the rear cover while pushing the push buttons on the top.

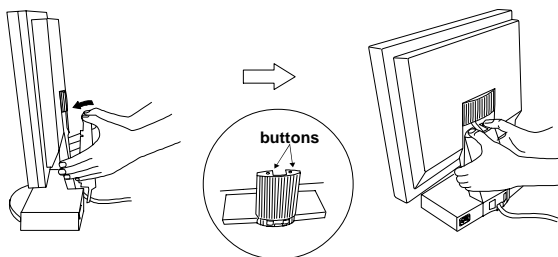

(7) Plug the power cord into the power connector in the rear of the LCD monitor. Plug the other end into a power outlet.

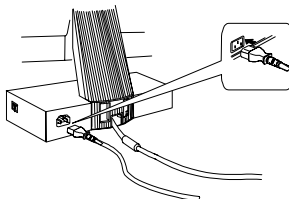

(8) Turn on the monitor's main power and then switch on the PC power.

(9) This completes the installation. Turn off the main power when you finish using it.

NOTE

- Do your part to conserve energy, turn off the monitor when you are finished using it.

How to remove the connector cover and the rear cover of the LCD monitor.

(1) To open easily the LCD monitor should be tilted forward as shown in the diagram.

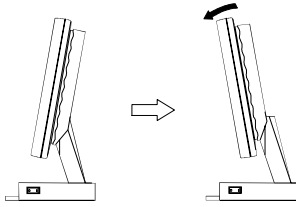

(2) Pull the rear cover clear while pushing the push buttons on the top.

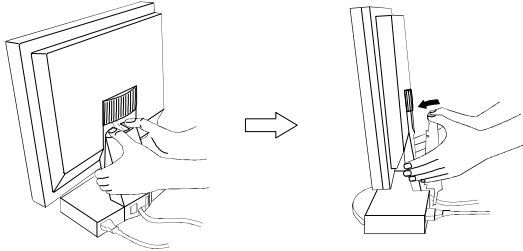

(3) Pull down and remove the connector cover.

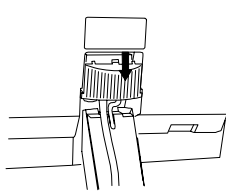

Connecting two PCs to the Monitor

(Example)

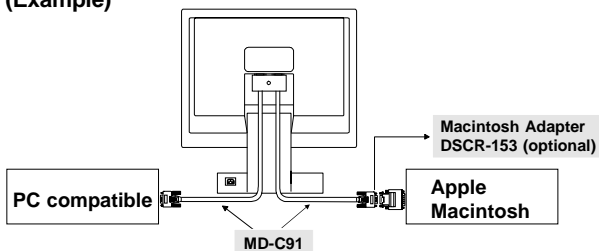

The EIZO L66 has two video input signal connectors (2 x D-sub mini 15 pin). The priority switch system allows the user to assign priority to either input signal.

NOTE

- Use the specified optional cable: MD-C91 only or with Macintosh adapter when connecting the second computer to the monitor.
- Contact EIZO dealers for information about optional cables.
- Be sure that the monitor and the PC are both switched off before connecting them.
- Be sure to connect the cable securely.

Selecting the Active Input

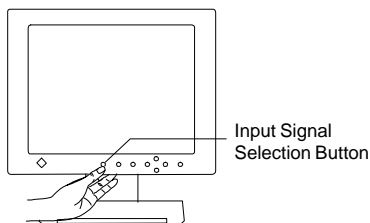

- The Input signal selection button on the front panel can be used to select Signal 1 or Signal 2 as the active input.
- The ScreenManager “Input Priority” setting (in the “Others” menu) can be used to set up the automatic selection of the input. See page 56 for details.

Connecting the Cables (Free Mount Type)

- (1) Be sure that the power switches of both the PC and the power unit are OFF. Lay the LCD monitor as shown below.

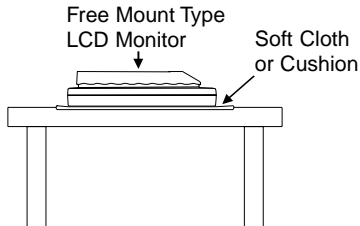

- (2) Plug the power unit into the power connector in the rear of the LCD monitor.

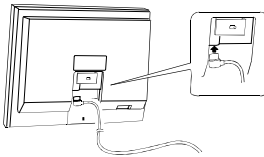

- (3) Remove the D-Sub connector holder.
- Hand-loosen the screws at the center of the holder.
 - Pull the holder away while squeezing the both sides of the holder.

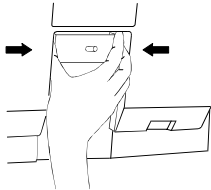

- (4) Plug the signal cable (which is marked “LCD”) into the D-Sub connector (Signal 1) at the rear of the monitor. Please ensure that the arrow mark on the casing of the connector is visible when connecting. See note.

NOTE

When connecting the signal cable, check that the shape of the cable connector matches the shape on the LCD monitor.

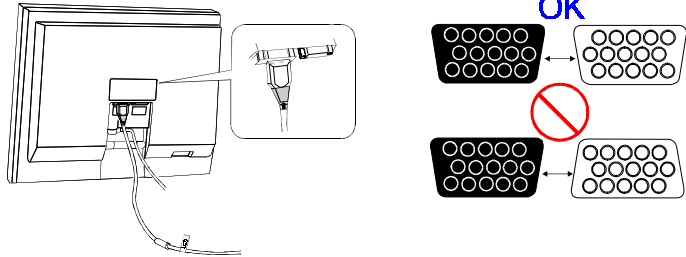

- (5) Replace the D-Sub connector holder and hand-tighten the screw.

- (6) Place the bracket on the rear of the LCD monitor. Fix the bracket to the rear of the LCD monitor securely. Place and fix a mount or an arm-stand to the monitor.

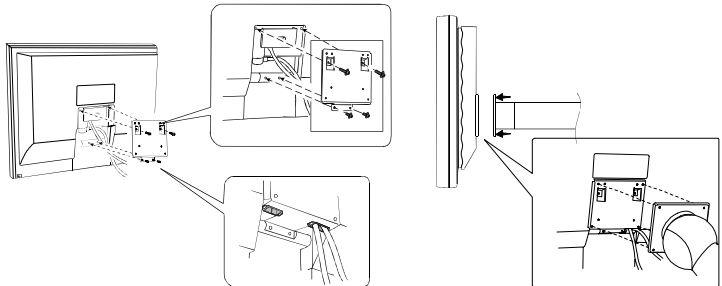

NOTE

- In case of using this LCD monitor with an arm-stand in an office workspace, the arm-stand shall be chosen and used carefully:
 - Use only an approved arm-stand (e.g. GS).
 - The arm-stand shall have sufficient stability (mechanical firmness) to support the weight of the monitor including the recommended optional parts (minimum support is 9.0 kg).
 - The arm-stand shall remain in that position where it is manually moved.
 - The arm-stand shall have the ability to tilt the monitor forward and backward.

- The height of the upper row shall be less than or equal to 500 mm in relation to the desk surface when the arm-stand is in its lowest position.

(Example)

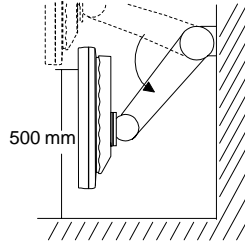

- Use a VESA approved arm-stand.
- The LCD panel requires 100 mm x 100 mm hole spacing on the arm mounting pad. The arm-stand should be able to support an object weighing 13.5 kg.

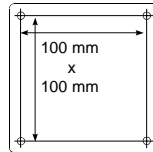

(7) Plug the other end of the cable into the video connector on the rear of the PC.

Standard PC graphics board

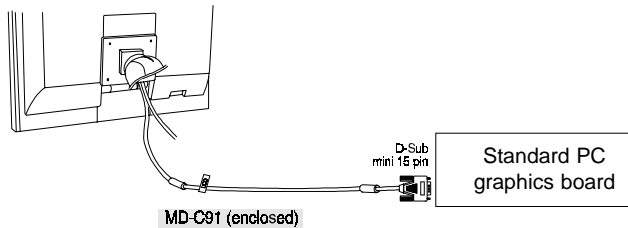

Macintosh

Please connect the optional Macintosh adapter to the PC before attaching the signal cable.

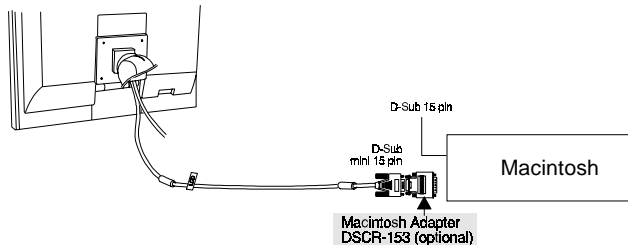

- (8) Plug the power cord into the power unit, and plug the other into a power outlet.

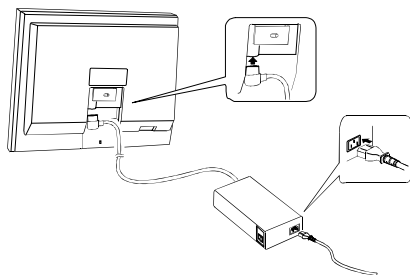
**NOTE**

- In case of setting the plural free mount type monitors, please be sure to observe the followings.
 - *Do not pile the power units.
 - *Set the power units at minimum intervals of 20 mm. Refer to the diagram below.

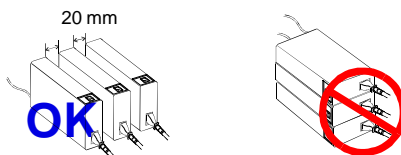

- (9) Turn on the monitor's main power and then switch on the PC power.
- (10) This completes the installation. Turn off the main power when you finish using it.

NOTE

- Do your part to conserve energy, turn off the monitor when you are finished using it.

Connecting two PCs to the Monitor

(Example)

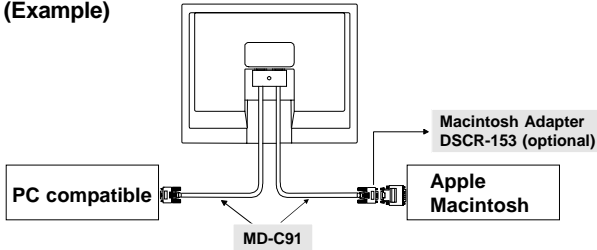

The EIZO L66 has two video input signal connectors (2 x D-sub mini 15 pin). The priority switch system allows the user to assign priority to either input signal.

NOTE

- Use the specified optional cable: MD-C91 only or with Macintosh adapter when connecting the second computer to the monitor.
- Contact EIZO dealers for information about optional cables.
- Be sure that the monitor and the PC are both switched off before connecting them.
- Be sure to connect the cable securely.

Selecting the Active Input

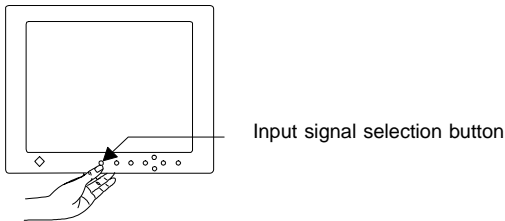

- The Input signal selection button on the front panel can be used to select Signal 1 or Signal 2 as the active input.
- The ScreenManager “Input Priority” setting (in the “Others” menu) can be used to set up the automatic selection of the input. See page 56 for details.

2 USING THE SCREENMANAGER

2-1 How to use the ScreenManager

About ScreenManager

As shown on the display, the ScreenManager is used to adjust the LCD monitor. Adjustments are made using the Enter and Control buttons (up, down, right and left) located on the front panel.

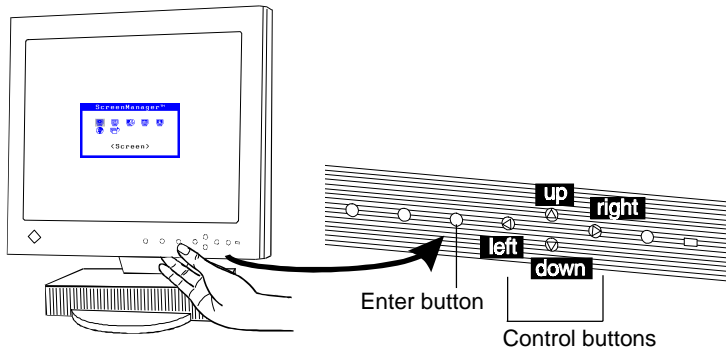

ScreenManager Menus

ScreenManager consists of a main menu and six sub menus: “Screen”, “Color”, “PowerManager”, “Others”, “Information” and “Language.” Animated icons on each menu allows for easy adjustment.

Main menu

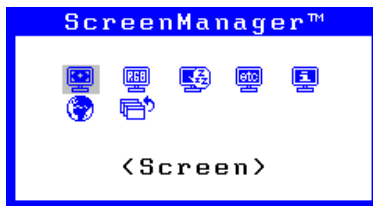









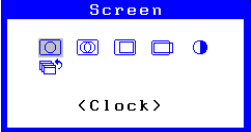

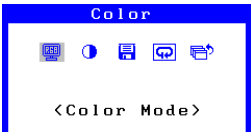
NOTE

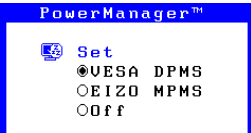

- The menu message for the ScreenManager can be displayed in six languages: English, German, French, Italian, Spanish and Swedish. First, select the preferred language through the “Language” menu. This will become the default language when you use the ScreenManager.

Sub menus

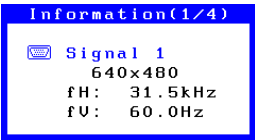
Icon	Menus	Functions	Reference
	<p>Screen menu</p> 	<p>Each display mode can have various screen parameters adjusted to enhance viewing. There are:</p> <ul style="list-style-type: none"> * Clock * Phase * Position * Resolution * Contrast / Brightness 	<p>Ch. 2-2 (pg.34)</p>
	<p>Color menu</p> 	<p>Use this menu to select color mode: 1, 2 or 3. By adjusting the red, green, and blue color tones for each mode, custom colors can be defined.</p>	<p>Ch. 2-3 (pg.45)</p>
	<p>PowerManager menu</p> 	<p>Use this menu to configure the power saving features. Default setting is VESA setting.</p>	<p>Ch. 2-4 (pg.48)</p>
	<p>Others menu</p> 	<p>Use this menu to configure the following features:</p> <ul style="list-style-type: none"> * Screen Size * Border Intensity * Input signal priority selection for two signal connections * Off Timer * Beep On/Off * ScreenManager menu position * Reset to defaults 	<p>Ch. 2-5 (pg.53)</p>

Icon	Menus	Functions
	<p style="text-align: center;">Information menu</p> 	<p>Use this feature to review the current ScreenManager settings. The menu contains four pages. Pushing the Enter button selects each page in order. The information displayed for each page is as follows:</p> <ul style="list-style-type: none"> * Page 1: "Screen" menu settings * Page 2: "Color" adjustment settings * Page 3: "PowerManager" settings * Page 4: "Others" menu settings
	<p style="text-align: center;">Language menu</p> 	<p>Use this menu to select the ScreenManager language. A choice of six languages are available English, German, French, Spanish, Italian and Swedish. The menu text will change to the language selected.</p>

How to use the ScreenManager

Entering the ScreenManager

Push the Enter button once to display the main menu of the ScreenManager.

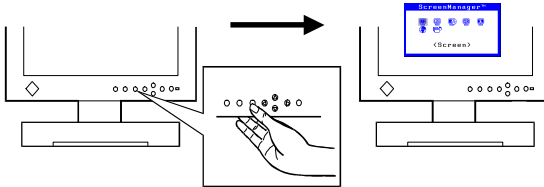

Enter the Settings

- (1) To enter any sub menu icon, highlight the desired icon by using the Control buttons (up, down, right and left) and push the Enter button. The sub menu appears.
- (2) Use the Control buttons to select the desired setting icon and push the Enter button.
- (3) The setting menu appears. Use the Control buttons to make all required adjustments.

Save

To save settings and go back to the previous menu, push the Enter button. A long beep will be heard indicating the adjustment settings have been saved.

Exit the ScreenManager

- (1) To return to the main menu, select the “Return” icon or push the down button twice, followed by the Enter button.
- (2) To exit the ScreenManager, select the “Exit” icon and push the Enter button. Double clicking the Enter button at any time also exits the ScreenManager menu.

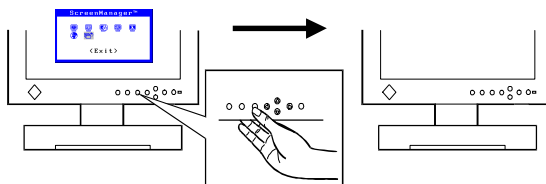

NOTE

- **Return & Exit icons**

To return to the main menu from the sub menu or exit the ScreenManager, select this icon and push the Enter button.

Shortcut keys

Brightness and contrast can be adjusted directly without any need to enter the ScreenManager. Press the Control buttons to adjust the settings and then the Enter button to save all changes.

See the diagram below for adjustment directions.

The brightness and contrast functions are also available in the ScreenManager “Screen” menu.

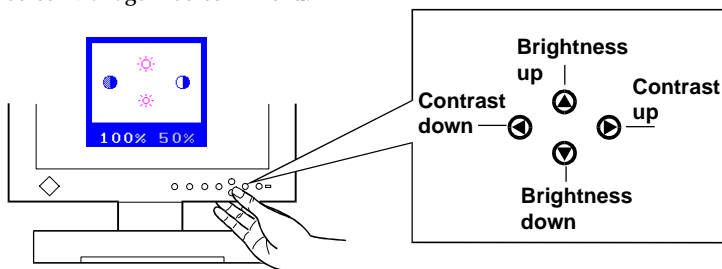

Adjustment Lock

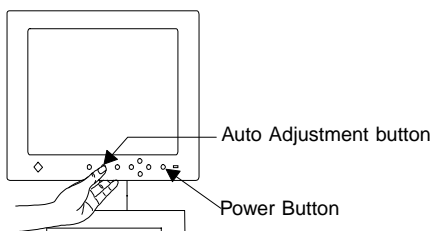

The ScreenManager operation can be disabled by holding down the Auto adjustment button while switching on the LCD monitor's power. This will disable (“lock”) the Enter button and Auto adjustment button, protecting from accidental changes. To unlock the buttons, switch the power off. Switch the power on while pressing the Auto adjustment button.

Note the brightness and contrast can be adjusted using the shortcut keys even while the Enter button is locked. After making such an adjustment, the Enter button can be used to clear the brightness/contrast adjustment menu from the screen. Furthermore, the Input signal selection button can still be used while the adjustment lock is on.

2-2 Screen Adjustment

About Screen Adjustments

Entering the ScreenManager, select the “Screen” icon and push the Enter button to show the “Screen” menu.

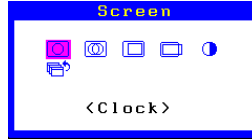
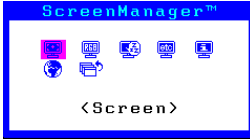

“Screen” adjustments for the LCD monitor should be used in suppressing screen flickering and also for adjusting the screen to its proper position. There is only one correct position for each display mode. It is also recommended to use the ScreenManager function when first installing the display or whenever changing the system.

The following eighteen (18) common display modes have been preset in the L66 monitor’s memory, and require no screen adjustment. If the mode input to the LCD monitor is not one of the preset modes, the adjustments must be made using the Auto adjustment button and ScreenManager “Screen” menu.

mode	
1	VGA 640 x 480 (60 Hz)
2	VGA 720 x 400 (70 Hz)
3	VESA 640 x 480 (72Hz)
4	VESA 640 x 480 (75 Hz)
5	VESA 640 x 480 (85 Hz)
6	VESA 800 x 600 (56 Hz)
7	VESA 800 x 600 (60 Hz)
8	VESA 800 x 600 (72 Hz)
9	VESA 800 x 600 (75 Hz)
10	VESA 1024 x 768 (60 Hz)
11	VESA 1024 x 768 (70 Hz)
12	VESA 1024 x 768 (75 Hz)
13	VESA 1024 x 768 (85 Hz)
14	VESA 1280 x 1024 (60 Hz)
15	VESA 1280 x 1024 (75 Hz)
16	Apple Macintosh 640 x 480 (67 Hz)
17	Apple Macintosh 832 x 624 (67 Hz)
18	Apple Macintosh 1152 x 870 (75 Hz)

For convenience, an easy set-up Program installed on the utility disk to assist in the set-up procedure is provided. For set up see the next page.

Adjustment Procedure

Overview

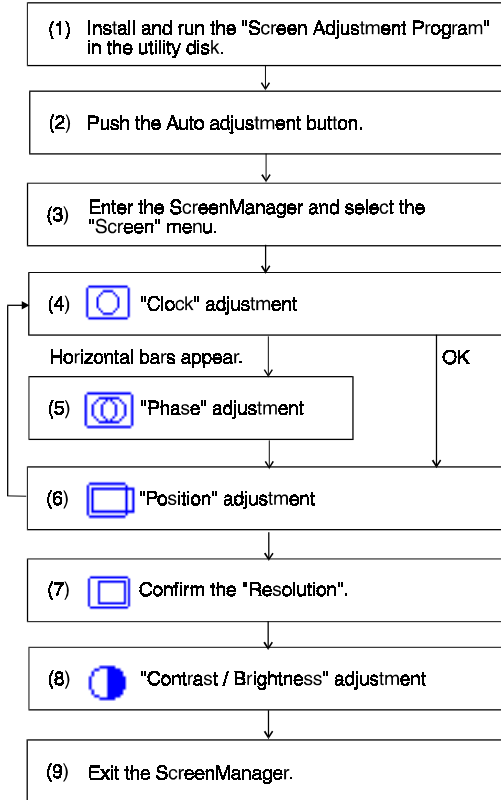

NOTE

- Allow the LCD monitor to warm up for at least 20 minutes before making adjustments.
- For maximum viewing comfort, it is suggested that the monitor be tilted to eye level.
- To make adjustment easily, install and run the "Screen Adjustment Program" in the attached utility disk. Before adjustment, read the "readme.txt" file.
- Do not continuously press the Control buttons (up, down, right and left buttons) on the front panel, as the adjustment value will change quickly and make it difficult to locate the most suitable adjustment point.

Procedure

Please adjust the screen using the following procedure.

(1) Having read the “readme.txt” file, install and run the “Screen Adjustment Program” in the utility disk.

Step by step adjustment is provided by the wizard guide. Follow the wizard or the procedures (2) to (8) below.

NOTE

- If the user's operation system has no utility disk (e.g. OS/2), we recommend setting the desktop pattern to that as shown in the diagram below.

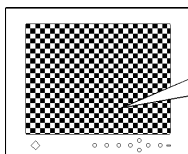

Every-other-dot pattern

(2) Auto Adjustment

Push the Auto adjustment button on the front panel. The following message will appear and remain on the screen for 5 seconds. While the message is on the screen, push the button again to automatically adjust the screen position. If you do not wish to do adjust the screen, do not push the button again. The message will disappear.

Your setting will
be lost, if you
press again now.

NOTE

- The Auto adjustment function is intended for use on Macintosh and PCs running Windows. It may not function properly if any of the following applies:
 - PC running MS-DOS (not Windows).
 - The background color for the “wallpaper” or “desktop” pattern is set to black or dark.
 - Some signals from some graphics boards may not function properly. Follow the adjustment procedure next page.



(3) Entering the ScreenManager "Screen" menu.

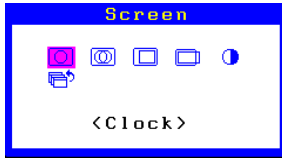

(4) "Clock" Adjustment

- a) Select the "Clock" icon and push the Enter button to enter the "Clock" menu.

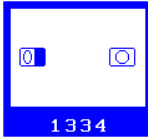

- b) If vertical bars of distortion on the screen appear, these can be eliminated by adjusting the right and left buttons. Then look at the illustration and the explanation below.
- If the screen is free from any bars of distortion, proceed to step (6) "Position" adjustment.
 - If horizontal flickering or horizontal bars appear, proceed to step (5) "Phase" adjustment.

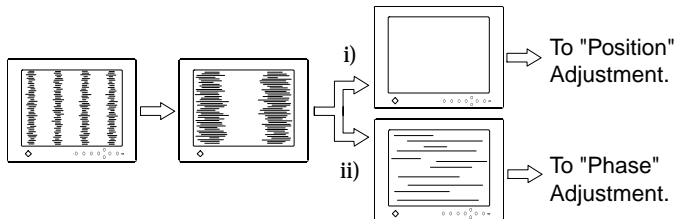

NOTE

- When adjusting the "Clock", the horizontal screen size will also change.
- c) Before going to the "Position" adjustment or "Phase" adjustment, push the Enter button to memorize the settings and return to the "Screen" menu.



(5) “Phase” Adjustment

- a) Select the “Phase” icon and push the Enter button to show the “Phase” menu.

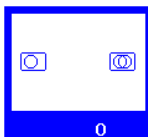

- b) If horizontal bars appear, these can be eliminated by adjusting the right and left buttons.

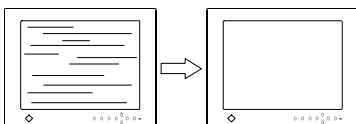

- c) After finishing the adjustment, push the Enter button to memorize the settings and return to the “Screen” menu.

NOTE

- “Phase” adjustments should be done after adjusting the “Clock”.
- Horizontal bars may not completely disappear from the screen depending on the PC.



(6) “Position” Adjustment

- a) Select the “Position” icon and push the Enter button to enter the “Position” menu. Adjustment markers are displayed on each corner of the screen.
- b) Adjust the position of the upper left corner of the image using the Control buttons in order to align the Screen. If the entire image still fails to fit inside the markers or is outside the markers, please proceed to the next step, “Resolution”.

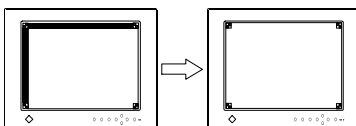

NOTE

- If vertical bars of distortion appear after finishing the “Position” adjustment, return to “Clock” menu and repeat the previously explained adjustment procedure (“Clock” “Phase” “Position”).
- c) After finishing the adjustment, push the Enter button to memorize the settings and return to the “Screen” menu.



(7) Confirm the “Resolution”.

- a) Select the “Resolution” icon and push the Enter button to enter the “Resolution” menu.

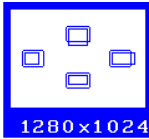

- b) Confirm if the resolution now being displayed is the same as the input resolution. If it is not, adjust the vertical resolution using the up and down buttons and adjust the horizontal resolution using the right and left buttons.
- c) After finishing the adjustment, push the Enter button to memorize the settings and return to the “Screen” menu.



(8) “Contrast” Adjustment

- a) Select the “Contrast” icon and push the Enter button to show the “Contrast/Brightness” menu.

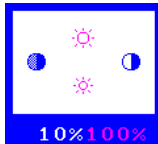

- b) Press the Auto adjustment button on the front panel while displaying the “Contrast/Brightness” menu to automatically adjust contrast.
- c) The screen blanks for a moment and adjusts the contrast to the maximum level of the current input signal.

NOTE

- After pressing the Auto adjustment button the value shown in percentages (%) will change from white to orange.
 - The changing percentage value from white to orange is the maximum contrast level. (This adjustment is also available manually; using the right and left buttons.)
- d) Adjust the “Brightness” as desired using the up and down buttons.
- e) After finishing the adjustment, push the Enter button to memorize the settings and return to the “Screen” menu.

(9) Exit the ScreenManager

- a) To return to the main menu, select the “Return” icon or push the down button twice, followed by the Enter button.
- b) To exit the ScreenManager, select the “Exit” icon and push the Enter button. Double clicking the Enter button at any time also exit the ScreenManager menu.

This is the end of the Screen adjustment procedure.

For more detailed information about each feature, refer to the next chapter, “Screen Adjustment Features”.

Screen Adjustment Features

This section gives more detailed information on various features. Please follow the previously explained adjustment procedure for screen adjustment.

1. Clock Adjustment

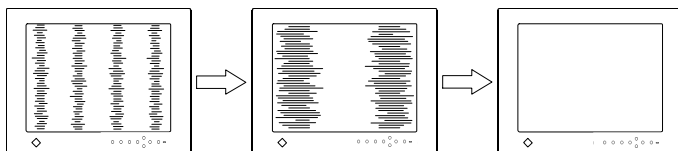

This feature decreases the vertical bars of distortion.

The EIZO L66 LCD monitor is designed for analog input signals from a standard graphics board. The analog input signal is converted to a digital signal by the LCD circuitry. To convert the signal correctly, the LCD monitor needs to produce the same number of clock pulses as the dot clock of the graphics system.

When the clock pulse is not correctly set, some vertical bars of distortion are displayed on the screen.

NOTE

- When adjusting the “Clock”, the horizontal screen size will also change.

2. Phase Adjustment

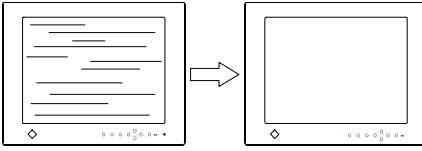

This feature eliminates the horizontal bars of distortion. The phase adjustment decides the sampling point for converting the analog input signal to a digital signal. Adjusting the “Phase” after the “Clock” adjustment will produce a clear screen.

3. Position Adjustment

This feature controls the screen position. The number of screen pixels and the screen position are fixed for the LCD monitor. Only one position is right and the displayed image should be adjusted to this position.

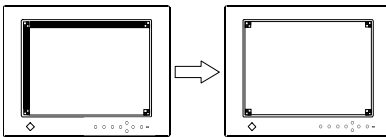

4. Resolution Adjustment

This feature sets a suitable screen area corresponding to each display mode. Use this function for adjusting the screen to a suitable size when it is displayed smaller or larger than the actual screen size.

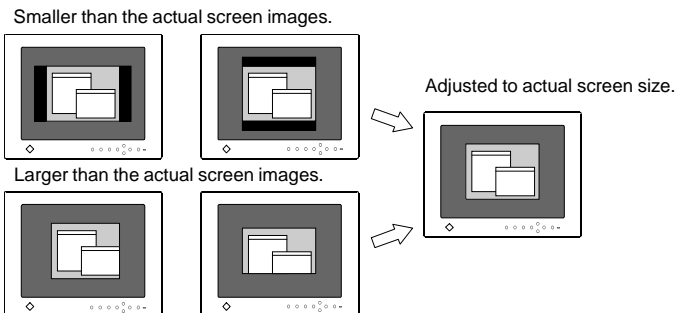

18 preset timings have been committed to memory. In addition to these settings, a screen can be displayed correctly using the “Clock”, “Phase” and “Position” adjustments if the input signal is one of the following resolutions (640 x 480, 720 x 400, 800 x 600, 832 x 624, 1024 x 768, 1152 x 870, 1280 x 1024).

If the signal is very different from one of the preset resolutions, then the screen can be adjusted using the “Resolution” Adjustment. The vertical resolution can be adjusted using the up and down buttons, and the horizontal resolution can be adjusted using the right and left buttons. When pushing the up or right buttons, the resolution is increased. When pushing the down or left buttons, the resolution is decreased.

NOTE

- The maximum resolution for the EIZO L66 LCD monitor is 1280 x 1024.

5. Contrast Adjustment

This feature controls the contrast of the screen. The contrast is changed by adjusting the gain level of the input signal to obtain the maximum contrast (0 ~ 63, 64 levels).

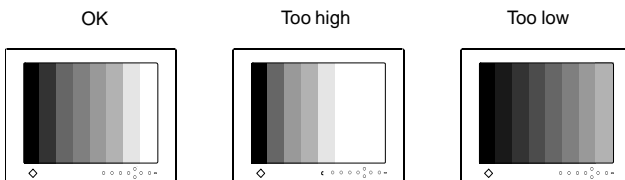

Bright area is displayed too whitish.

Adjustment procedure

(Auto)

- (1) Push the Auto adjustment button on the front panel while displaying the “Contrast/Brightness” menu to automatically adjust the contrast.
- (2) The screen blanks for a moment, and adjusts the contrast to the maximum contrast level of the current input signal.

(Manual)

Adjust the contrast level using the right and left buttons until the percentage color is on the border of white and orange or fully orange.

NOTE

- * In the case of the percentage color flickering between orange and white, please note that this is not an error but actually the most optimum adjustment point.
- * The brightness of the entire screen is controlled by changing the "Brightness" controls. No contrast adjustment is required except when the graphics board or the resolution is changed from the previous one.

6. Brightness Adjustment

This feature controls the brightness of the screen. The brightness of the entire screen is controlled by changing the brightness of the backlight. The black area on the screen is produced by shielding the backlight. Therefore, when changing the brightness of the backlight, the brightness of the black area on the screen will change very little.

2-3 Color Adjustment

About Color Adjustments

Entering the ScreenManager, select the “Color” icon and push the enter button to show the “Color” menu.

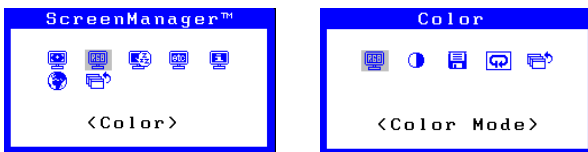

The ScreenManager “Color” menu provides 3 color setting modes; 1, 2, and 3. You can also adjust the color settings for each mode and store them for future use.

NOTE

- Allow the monitor to warm-up for at least 20 minutes before making an adjustment.

Color Mode

There are 3 color modes. You can select from these color tones when using white background applications with Windows or Macintosh. Note that the 3 color modes are similar when using black background applications.

Mode 1 (default):	The normal white color. It is the maximum contrast level. Please use this mode normally.
Mode 2:	The white color tone is slightly bluish.
Mode 3:	The white color tone is slightly reddish.

NOTE

- The contrast level is reduced in Mode 2 and 3.

Procedure



- (1) Select the “Color Mode” icon from the “Color” menu and push the Enter button.



- (2) Select option 1, 2 or 3 and push the Enter button. A long beep will be heard indicating the adjustment settings have been saved.

Custom Color Adjustments

By adjusting the red, green and blue color tones for each mode, custom colors can be defined. Please use this function when high precision color adjustment is required.

Procedure

NOTE

- Before you attempt to change the colors, always start with the color settings set to the default setting by using the “Reset” icon in each color mode.



- (1) Select the “Color Mode” icon from the “Color” menu and push the Enter button.



- (2) Select option 1, 2 or 3 and push the Enter button. You will hear a long beep indicating the option is selected.



- (3) Gain Adjustment

Gain

The Gain adjustment has no effect on the starting point (the black level). It changes only the ending point (the white level). The Gain adjustment is used to fine tune the whites and light grays to an even balance.

- a) Select the “Gain” icon. The screen shown on the left will appear.

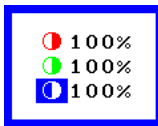

- b) Adjust each color until you can create a uniform white screen.



- (4) To register the adjustment, select the “Save” icon and then push the Enter button. If the settings are not saved, all adjustments will be lost.

- (5) Finally, re-adjust the contrast in the “Screen” menu to get the best image clarity.

NOTE

- After making the color settings, re-adjust the contrast to get the best definition and color intensity for the displayed image.



- “Reset”
You can recall the default color gain setting for the current color mode (1, 2, 3) using the “Reset” icon.
- The values shown in percentages represent the current level within the specific adjustment only. They are available only as a reference tool. (To create a uniform white or black screen, the percentages for each will probably not be the same.)

2-4 Power-save Setup

About PowerManager

Entering the ScreenManager, select the “PowerManager” icon and push the Enter button to show the “PowerManager” menu.

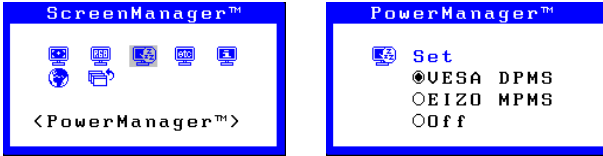

The PowerManager feature automatically reduces the monitor's power consumption during idle periods in accordance with the PC's ScreenSaver software.

Even if the monitor is in a power saving mode, it will return to a normal display immediately when the mouse or keyboard is operated.

The EIZO PowerManager functions comply with the VESA DPMS standard, EIZO MPMS, and the EPA's Energy Star® guidelines.

Power consumption:

Normal operation:	48 W
Power saving Mode:	less than 3 W*
	(Power Indicator solid yellow)
	*When the USB hub is not connected (Desktop stand type only)

NOTE

- Do your part to conserve energy, turn off the monitor when you are finished using it. Disconnecting the monitor from the power supply is recommended to save energy completely.

Set-up Procedure

Set the monitor's power saving environment to match the PC's ScreenSaver software.

NOTE

- For the PC setup, please refer to the user's manuals of the PC and the graphics board.

There are two power saving settings for the monitor.

“VESA DPMS” system works with the VESA DPMS signal.

“EIZO MPMS” system works with a screen saver software and Energy Saver for Macintosh which blanks the screen (totally black screen).

Set the monitor to match the PC's power saving software, as follows.

Monitor setting for matching the PC:

PC environment	PC Power saving	Monitor setting
PC running Windows (VESA DPMS activated)	VESA DPMS (Signal)	VESA DPMS
PC running Windows (VESA DPMS inactivated)	Windows (Control Panel/Display/ ScreenSaver: “Blank Screen”)	EIZO MPMS
Macintosh	Energy Saver	EIZO MPMS
	ScreenSaver software After Dark/“Blank” settings	EIZO MPMS

VESA DPMS System

- 1) First, make the appropriate settings for the PC. (See note, page 49.)
- 2) Then select "VESA DPMS".

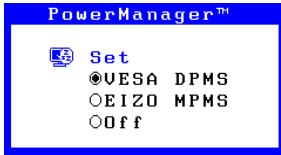

- 3) Set the delay period, which is the interval that the monitor will wait after receiving a power-save signal from the PC, before entering into Power Saving Mode.



VESA DPMS Power Saving Method

VESA DPMS utilizes four signals: ON, STANDBY, SUSPEND, and OFF. The monitor detects these signals from the graphics board and executes power saving accordingly, as illustrated below.

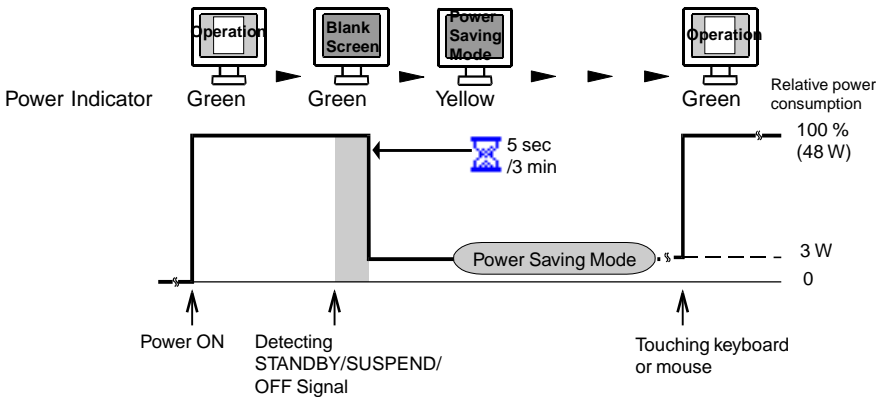

EIZO MPMS System

- 1) First make the appropriate ScreenSaver settings (Macintosh/Energy Saver) for the PC.
- 2) Then select "EIZO MPMS".

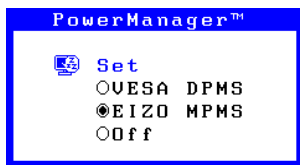

- 3) Set the delay time. This is the interval between the time that the ScreenSaver (Macintosh/EnergySaver) blanks the screen and the time that the monitor enters power saving mode.



EIZO MPMS Power Saving Method

When the PC is entering a ScreenSaver/Energy Saver mode, it interacts to the monitor, and the monitor shifts to Power Saving mode after the duration of the selected delay: 5 seconds/3 minutes.

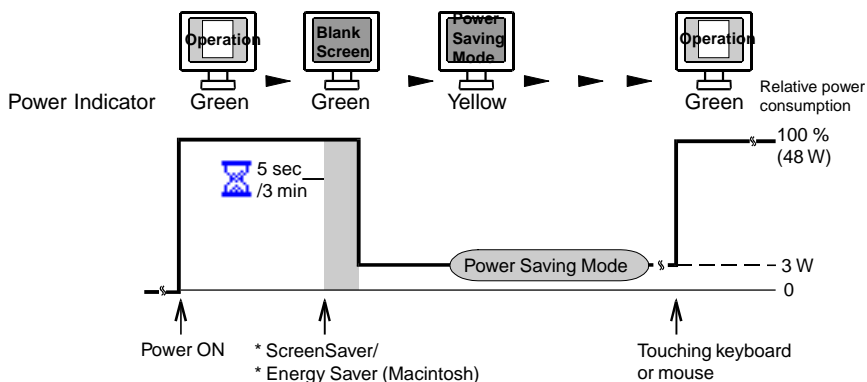

What is VESA DPMS?

The acronym VESA stands for “Video Electronics Standards Association,” and DPMS stands for “Display Power Management Signaling.” DPMS is a communication standard that PCs and graphics boards use to implement power savings at the monitor side.

What is EIZO MPMS?

EIZO MPMS, “EIZO Monitor PowerManager Signaling”, also enables to execute power saving at the monitor side. EIZO MPMS recognizes the video signals from the PC when the PC is in a power saving mode, and reduces energy consumption of the monitor.

What is Energy Star®?

“Energy Star®” is a set of power-saving guidelines issued by the U.S. Environmental Protection Agency (EPA). The guidelines apply to PC systems and peripherals.



As an Energy Star Partner, EIZO NANA CORPORATION has determined that this product meets the Energy Star guidelines for energy efficiency.

2-5 Other Settings

About Other Settings

Entering the ScreenManager, select the “Others” icon and push the Enter button to show the “Others” menu.

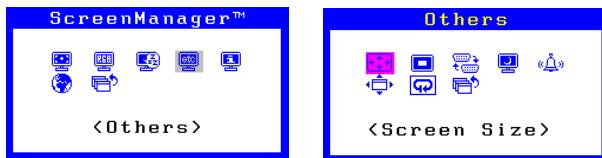

All of the icons shown in the ScreenManager “Others” menu are described below.

Screen Size



This function shows the image in its original size or enlarged to fit the full screen of the LCD panel.

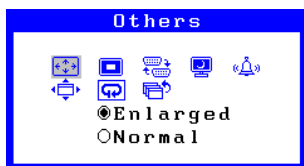

Setup Procedure

Please setup the screen size using the following procedure:

- (1) Select the “Screen Size” icon and push the Enter button to show the “Normal / Enlarged” select menu.
- (2) Select “Enlarged” and push the Enter button to enlarge the image and return to the “Others” menu.
- (3) Select the “Return” icon and push the Enter button to return to the main menu of the ScreenManager.
- (4) Select the “Exit” icon and push the Enter button to exit the ScreenManager.

What is the “Screen Size” setup function?

The LCD panel consists of a fixed number of pixel elements which are illuminated to form the screen image. The EIZO L66 display panel consists of the following pixel elements: 1280 horizontal pixels and 1024 vertical pixels. At the resolution of 1280 x 1024, all pixels are used and the image is displayed as a full screen. At the lower display modes of 1024 x 768, 800 x 600, or 640 x 480 the images are displayed in the center of the screen using a smaller portion of the pixels. Using the screen size setup function, these display modes of 680 x 480, 720 x 400, 800 x 600, 832 x 624 can be enlarged to full screen.

When selecting the “Enlarged” mode, the image is enlarged to almost the full screen size. When selecting the “Normal” mode, the image is displayed at the center of the original screen size.

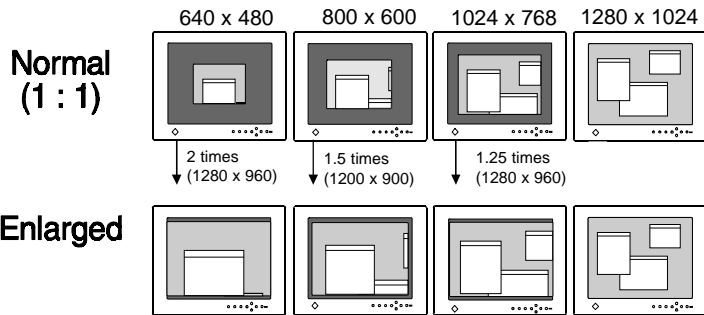

NOTE

- In the “Enlarged” mode, the image is enlarged by 1.25 times, 1.5, or 2 times the original size. However, since the pixel elements are fixed, some lines of the characters or pictures may be displayed with a different width.
- Some display modes, which exceed 1280 x 1024 when enlarged 1.25 times, (e.g. Macintosh's 21" mode (1152 x 870), cannot be enlarged with this function.
- This function does not work at the dot clock of 83 MHz or more (e.g. 1024 x 768 @ 85 Hz).
- When the lower resolution screen is enlarged, the margin of the enlarged screen and the maximum screen size (1280 x 1024) becomes borders. See the pictures shown above.

Border Intensity

-  This function is used for changing the brightness of the black area surrounding the displayed image.

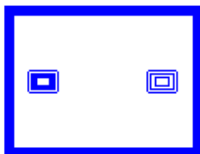

Adjustment Procedure

Please adjust the border intensity using the following procedure:

- (1) Select the "Border Intensity" icon and push the Enter button to display the adjustment menu.
- (2) Adjust the brightness of the border area using the right and left buttons.
- (3) Push the Enter button to return to the "Others" menu.
- (4) Select the "Return" icon and push the Enter button to return to the main menu of the ScreenManager.
- (5) Select the "Exit" icon and push the Enter button to exit the ScreenManager.

What is the "Border Intensity" function?

With lower resolutions of (640 x 480, 800 x 600, 1024 x 768, etc.) the image is displayed at the center of the screen and the outer area (border) is usually black. The "Border Intensity" function can set the brightness of this border area to any brightness level that maybe desired.

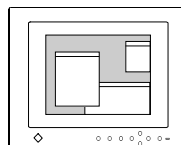
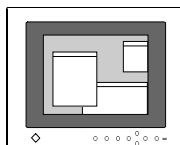
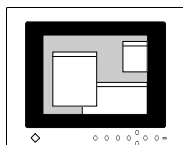

→ brighter

Input Priority



This function is used to select which PC will have priority to control the monitor when utilizing two PCs.

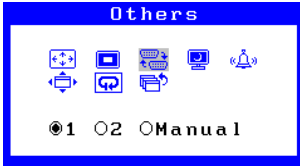

As you can see in the picture, there are three settings available: “Signal 1”, “Signal 2” or “Manual”. The default priority setting is “Signal 1”.

The monitor constantly checks the input signals and switches automatically in accordance with the “Input Priority” settings (see chart below). Once a priority is set, whenever a change of signal is detected at the selected input, the monitor will switch the input to that signal.

In the case of only one signal being present at either input, the monitor automatically detects and displays that signal.

Priority setting	Performance
Signal 1	If signals from both inputs are present, the monitor gives preference to Signal 1 for the cases shown below: <ul style="list-style-type: none">• When the power of the monitor is turned ON (see note 1).• When the signal input to Signal 1 is changed even if active input was Signal 2.
Signal 2	If signals from both inputs are present, the monitor gives preference to Signal 2 for the cases shown below: <ul style="list-style-type: none">• When the power of the monitor is turned ON (see note 1).• When the signal input to Signal 2 is changed even if active input was Signal 1.
Manual	The monitor will not detect signals automatically in this mode. Select the active input by pressing the input signal selection button on the monitor’s front panel.

NOTE

- 1 The Input Priority function does not automatically re-activate when the monitor has been in the power saving mode.
- 2 The Input selection button on the front panel can be used to select either Signal 1 or Signal 2 as the active input at any time.

Procedure for Input Priority Selection

Please set the Input priority using the following procedure:

- (1) Select the “Input priority” icon and push the Enter button to show the “Signal 1/Signal 2/ Manual” select menu.
- (2) Set the signal priority using the right and left buttons.
- (3) Push the Enter button to return to the “Others” menu.
- (4) Select the “Return” icon and push the Enter button to return to the main menu of the ScreenManager.
- (5) Select the “Exit” icon and push the Enter button to exit the ScreenManager.

Off Timer

The Off Timer function allows the user to set the time in which the monitor will be in operation, called the “On Period” and automatically shifts the operation into the “Power Off” mode when the set “On Period” expires.

The Off Timer function was created to reduce after-image characteristics that are particular to LCD monitors when the monitor screen is left on for a long period without use.

The default setting for the Off Timer is “disable”. For setup, please see below.

**NOTE**

The Off Timer will work while PowerManager is active, but there would be no advance notice before the monitor's power switches off.

Setup Procedure

- (1) Select the "Off Timer" icon and press the Enter button to display "Off Timer" select menu.
- (2) Select "Enable" and press the enter button.
- (3) Press the right/left key to adjust how long (1 to 23 hours) the monitor should be in the "On Period". Then, press the enter button to return to the "others" menu.



- (4) Select the "Exit" icon and push the Enter button to exit the ScreenManager.

Advance notice (beep with LED flashing green) will be given 15 minutes before the monitor will automatically turn off and enter the "Power Off" modes. To turn off the beeper, see page 59.

To Delay Entering Power Off

To delay entering the "Power Off" mode, press the power button on the front panel located to the left of the LED light during the advance notice period. The monitor will continue to operate for an additional 90 minutes. There will be another advance notice for 15 minutes as described. Delayed entrance into the "Power Off" period can be extended as many times as desired.

(Example)

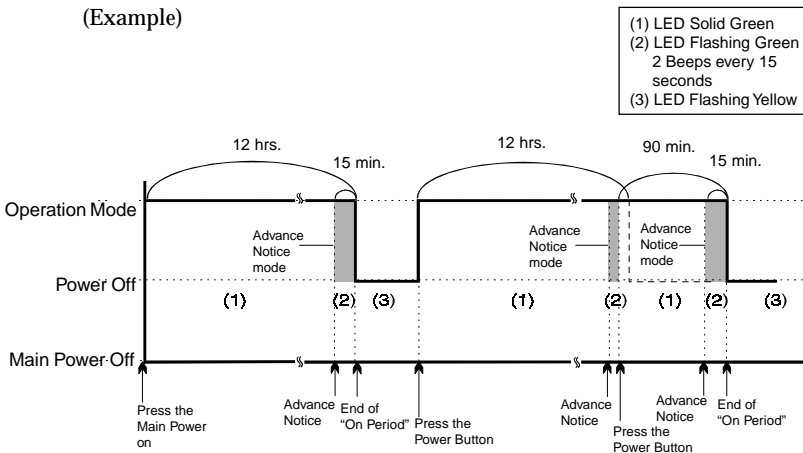

Beep



Use this feature to set the beeper On or Off. If the beeper is On, the LCD monitor will generate beep signals as defined below. If the beeper is Off, the monitor will not beep.



Short beep	<ul style="list-style-type: none"> • ScreenManager item selected. • ScreenManager parameter adjusted to minimum or maximum limit. • Input signal selection button pressed.
Long beep	<ul style="list-style-type: none"> • Auto Adjustment button pressed. • ScreenManager data-save executed.
Four short beeps	<ul style="list-style-type: none"> • Monitor not connected correctly. • PC turned off. • Monitor received unsupported signal frequency.
Two short beeps every fifteen seconds	<ul style="list-style-type: none"> • Monitor is in the advance notice mode of the Off Timer. The power will be off within fifteen minutes.

Procedure for Beep Selection

Please set the beeper using the following procedure:

- (1) Select the “Beep” icon and push the Enter button to show the “On/Off” select menu.
- (2) Set the On/Off using the up and down buttons.
- (3) Push the Enter button to return to the “Others” menu.
- (4) Select the “Return” icon and push the Enter button to return to the main menu of the ScreenManager.
- (5) Select the “Exit” icon and push the Enter button to exit the ScreenManager.

Menu Position



Use this function to adjust the position of the ScreenManager menu.

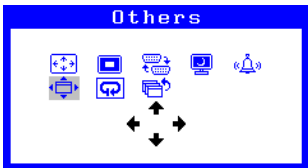

Procedure for Menu Position Selection

Please set the Menu Position using the following procedure:

- (1) Select the “Menu Position” icon and push the Enter button to display the adjustment menu.
- (2) Set the position using the right, left, up and down buttons.
- (3) Push the Enter button to return to the “Others” menu.
- (4) Select the “Return” icon and press “Enter’ to return to the main menu of the ScreenManager.
- (5) Select the “Exit” icon and push the Enter button to exit the ScreenManager.

Reset



Use this function to return all ScreenManager parameters (size, position, color, PowerManager etc.) to their factory default settings.



Default settings are as follows:

- Screen: Brightness = 100%, Contrast = 70%
- Color: Mode 1/Normal white
- PowerManager: VESA DPMS/5 sec.
- Others: Screen size = Normal
Input Priority = Signal 1
Off Timer = Disable
Beep = On
- Language: English

Procedure for Reset Selection

Please reset the default using the following procedure:

- (1) Select the “Reset” icon and push the Enter button to show the adjustment menu.
- (2) Select “Reset” using the up and down buttons. A confirmation message will appear.
- (3) Push the Enter button to proceed and return to the “Others” menu.
- (4) Select the “Return” icon and push the Enter button to return to the main menu of the ScreenManager.
- (5) Select the “Exit” icon and push the Enter button to exit the ScreenManager.

3 MAKING USE OF USB

-For USB Compliant System Environments-

(Desktop Stand Type Only)

The Desktop Stand Type provides a hub which supports the USB (Universal Serial Bus) standard. When connecting to a USB compliant PC or another hub, the monitor functions as a hub to which USB compliant peripherals can be connected. The USB standardized connectors enable the easy connection with these peripherals.

NOTE

- To utilize the USB hub function, the following system environment is required.
 - PC equipped with USB ports or another USB hub connected to the USB compliant PC
 - OS (Windows 98/Mac OS 8.5.1 or newer)
 - EIZO USB cable (MD-C93, enclosed)
- Do not connect any peripherals until finishing USB function setup.
- The USB hub function may not work properly with some systems. Please consult the manufacturer of each system for details about this feature.
- When the monitor is not on, the peripherals connected to the downstream ports will not operate.
- When the monitor is in a power saving mode, the connected USB compliant devices will operate.

Monitor USB Function Setup

Before the setup, connect the monitor to the PC with the signal cable (see page 18) and turn on the PC.

(For Windows 98)

- 1) Connect the upstream port of the monitor to the downstream port of the USB compliant PC or another hub using the EIZO USB cable (MD-C93).

NOTE

- When connecting the USB cable, check that the shape of the connector at the cable side matches the shape at the connecting side.

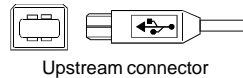
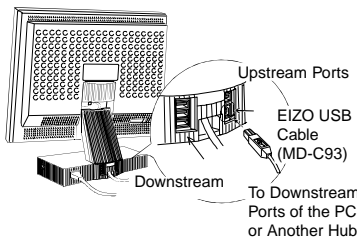

Upstream Port:
Connect the USB compliant PC or another hub using the EIZO USB cable (MD-C93).

- 2) "Unknown Device" is found on the "Add New Hardware Wizard" screen. "Generic USB Hub" should be chosen. Click "Next".

- 3) Select “Search for the best driver for your device (recommended).” and click “OK”.
- 4) Insert the Windows 98 CD-ROM.
- 5) Select “specify a location” and choose the driver where Windows 98 is installed (e.g., select c: if Windows 98 is in C drive), and click “Next”.
- 6) Confirm “Generic USB Hub” is selected in the wizard. Click “Next”.
- 7) Choose the driver where CD-ROM is installed (e.g., d:\win98), and click “OK” if the location of the driver is asked.
- 8) The “Generic USB Hub” is detected. Click “Finish” to complete the installation.

Once the above operation is completed, the monitor functions as a USB hub and the USB compliant peripherals can be connected to the downstream ports of the monitor.

(For MacOS 8.5.1 or newer)

There is no need to install any software to utilize the USB hub function when connecting a USB compliant PC (or another USB hub) with the USB cable (MD-C93).

Connect the USB compliant peripherals to the downstream ports of the monitor.

(Example of connection)

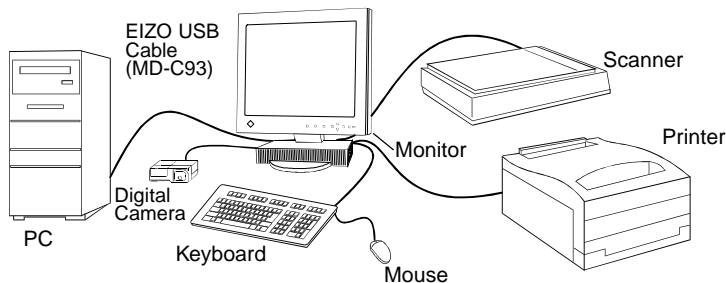

Rear port (Example)

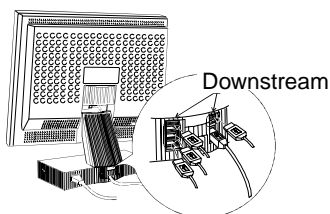

Downstream connector

Downstream ports:
Connect the cables from USB compliant peripherals such as a mouse, keyboard, etc.

USB Specifications

USB standard	Rev. 1.0 complied self-powered hub
Downstream power supply	500 mA for each (Max.)
Communication speed	12 Mbps (full), 1.5 Mbps (low)
USB ports	Upstream port x 1 Downstream ports x 4

Troubleshooting

Problems	Points to check with possible solutions
1) • USB function cannot be setup.	<ul style="list-style-type: none"><input type="checkbox"/> Check that the USB cable is correctly connected.<input type="checkbox"/> Check that the PC and OS is compliant to the USB. (For the USB support of the system, consult the manufacturer of each system.)<input type="checkbox"/> Check the PC's BIOS setting for the USB. (For details, refer to the manual of the PC.)
2) • PC is hung up. • The peripherals connected to the downstream ports do not operate.	<ul style="list-style-type: none"><input type="checkbox"/> Check that the USB cable is correctly connected.<input type="checkbox"/> Check the downstream ports by connecting the peripherals to other downstream ports. If the problem is solved by doing this, contact an EIZO dealer.<input type="checkbox"/> Try executing the following method.<ul style="list-style-type: none">* Restarting the PC* Connecting the PC and peripherals directlyIf the problem is solved by doing this, contact an EIZO dealer.<input type="checkbox"/> The power button of the APPLE keyboard does not operate if it is connected to the EIZO USB Hub. Please connect the keyboard directly with the PC. Refer to the instruction of the PC for details.

4 TROUBLESHOOTING

4-1 Troubleshooting

This page presents problems that can be corrected by the user. If a problem persists even after applying the suggested remedies, contact an EIZO dealer.

E

■ No picture

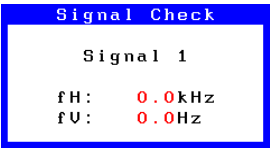
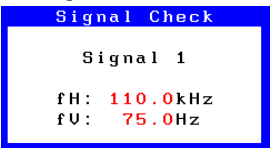
Problems	Points to check with possible solutions
1) Indicator status: OFF 2) Indicator status: GREEN 3) Indicator status: YELLOW (flashing) 4) Indicator status: YELLOW	<ul style="list-style-type: none"><input type="checkbox"/> Check that the power cord is securely connected.<input type="checkbox"/> Try pressing a key on the keyboard, or clicking the mouse. (The screen-saver software may be active.)<input type="checkbox"/> Try pressing the power button. (The off timer may be active.)<input type="checkbox"/> Check brightness and contrast settings. Minimum settings will cause screen to be blank.<input type="checkbox"/> Try pressing the power button. (The power button may be switched off.)<input type="checkbox"/> Try pressing a key on the keyboard, or clicking the mouse. (The screen-saver software may be active.) <p>If the problem persists, switch off the monitor main power for a few minutes, then switch it back on and try again.</p>
5) "No signal detected" error message appears. 	<ul style="list-style-type: none"><input type="checkbox"/> Check that the PC is switched ON.<input type="checkbox"/> Check that the signal cable is properly connected to the graphics board or PC.<input type="checkbox"/> Check that the graphics board is correctly inserted in the PC.<input type="checkbox"/> Switch the signal input by pushing the input signal selection button on the front control panel.<input type="checkbox"/> For Windows 95/98 users, install the "Monitor information file" in the utility disk.
6) "Out of range" error message appears. (Example) 	<ul style="list-style-type: none"><input type="checkbox"/> Use the graphics board's utility software to change the frequency setting. (Refer to the manual of the graphics board.)<input type="checkbox"/> For Windows 95 users (OSR 2.0 or newer)/98, restart the PC in a safe mode and change the frequency at the "Display" setting in the PC.

NOTE

- Whenever an error signal message appears, the signal frequency will be displayed in red.
- Error messages will remain on the screen for 30 seconds, and then disappear. An error message may not appear at all if the signal frequency is extremely high or extremely low.

■ Imaging problems

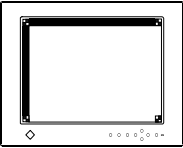
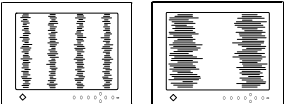
Problems	Points to check with possible solutions
<p>1) Display position is incorrect.</p> 	<ul style="list-style-type: none"> <input type="checkbox"/> Push the Auto adjustment button. See page 37. <input type="checkbox"/> Confirm the display resolution using the “Resolution” icon in the ScreenManager “Screen” menu. If the resolution is different from the selected display mode, adjust the resolution. See page 40, 42. <input type="checkbox"/> Adjust the image position using the “Position” icon in the ScreenManager “Screen” menu. See page 39, 42. <input type="checkbox"/> If the problem persists, use the graphics board's utility software to change the display position if available. (It may be called “back-porch”.)
<p>2) • The image vibrates on the screen.</p> <ul style="list-style-type: none"> • A slight shaking movement of the screen image or text. 	<ul style="list-style-type: none"> <input type="checkbox"/> Check that the signal cable is properly connected to the graphics board or PC. <input type="checkbox"/> Check that the graphics board is correctly mounted in the PC. <input type="checkbox"/> The signal cable might be damaged. Please contact the dealer. <input type="checkbox"/> The monitor may be located close to a device that is generating a magnetic field. Such devices include speakers, electric motors, high-voltage cables and other monitors. It may be solved by switching off or moving the interfering device, or by relocating the monitor.
<p>3) Vertical bars of distortion appear.</p> 	<ul style="list-style-type: none"> <input type="checkbox"/> Push the Auto adjustment button. See page 37. <input type="checkbox"/> Decrease the vertical bars using the “Clock” icon in the ScreenManager “Screen” menu. See page 38, 41.

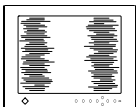
Problems	Points to check with possible solutions
4) Horizontal bars of distortion appear. 	<input type="checkbox"/> Decrease the horizontal bars using the “Phase” icon in the ScreenManager “Screen” menu. See page 39, 42.
5) The screen is too bright or too dark.	<input type="checkbox"/> Adjust the contrast and brightness using the ScreenManager’s Screen menu. See page 40, 43. (The backlight of the LCD monitor has a fixed life span. When the screen becomes dark or begins to flicker, please contact your dealer.)
6) After-images appear.	<input type="checkbox"/> When the screen image has been changed after displaying the same image for a long period, after-images may appear. Use the Off Timer function and avoid keeping the screen on all the time.
7) The screen has defective pixels (e.g. slightly light or dark).	<input type="checkbox"/> This is due to the characteristics of the panel itself, and not the LCD product.

■ Others

Problems	Points to check with possible solutions
1) The screen is unable to be enlarged.	<input type="checkbox"/> Some display modes, which exceed 1280 x 1024 when enlarged 1.25 times, (e.g. Macintosh's 21” mode (1152 x 870), cannot be enlarged with this function. <input type="checkbox"/> If the dot clock of the resolution is more than 83 MHz, the monitor can not enlarge the screen. (e.g. 1024 x 768 @ 85 Hz)
2) The monitor beeps.	<input type="checkbox"/> The monitor beeps at any time. This is not a problem. See page 59 for full details.
3) The utility disk is unable to be opened (for Macintosh only).	<input type="checkbox"/> Some PCs without PC-Exchange do not allow the utility disk to be opened. Please set the desktop pattern to ever-other-dot before adjustment. See page 37.
4) • The Enter button does not operate. • The Auto adjustment button does not operate.	<input type="checkbox"/> The adjustment lock is probably on. To unlock: switch the LCD monitor off. Then, while pressing the Auto adjustment button switch the power on. See page 33.

Problems	Points to check with possible solutions
5) The Auto adjustment button does not work properly.	<input type="checkbox"/> The Auto adjustment function is intended for use on Macintosh and IBM compatibles PCs running Windows. It may not work properly if either of the following applies. <ul style="list-style-type: none"> - You are running an AT-compatible PC on MS-DOS (not Windows). - The background color for the “wallpaper” or “desktop” pattern is set to black. <input type="checkbox"/> Some signals from the graphics boards may not function properly. Follow the adjustment procedure on page 18, adjust step by step using the “Screen” menu.
6) Frequency does not change after installing “Monitor information file” in the attached utility disk on Windows 95/98.	<input type="checkbox"/> Use the graphics board’s utility software to change the input signal frequency.

NOTE

- For problems with USB function, refer to the troubleshooting on page 64.

5 CLEANING

WARNING



- **Keep liquids away from the monitor.**
Spillage into the cabinet may result in fire, electric shock, or equipment damage.
If an object or liquid falls/spills into the cabinet, unplug the monitor immediately. Have the unit checked by a qualified service engineer before using it again.

CAUTION



- **To ensure safety, always unplug the monitor before cleaning it.**
Cleaning the monitor while it is plugged into a power outlet may result in electric shock.
- **Periodically clean the area around the plug.**
Buildup of dust, water, or oil on the plug may result in fire.
- **Dust accumulation within the monitor may result in fire or equipment failure.**
Please keep the monitor in a dust-free environment.
- **Never use thinner, benzene, alcohol (ethanol, methanol, or isopropyl alcohol), abrasive cleaners, or other strong solvents, as these may cause damage to the cabinet or LCD.**

Periodic cleaning is recommended to keep the monitor looking new and to prolong its operational lifetime. Clean the cabinet and LCD panel as follows.

Cabinet

To remove stains, wipe the cabinet with a soft, lightly moistened cloth using a mild detergent. Do not spray wax or cleaner directly onto the cabinet.

LCD panel



The LCD surface can be cleaned with a soft cloth, such as cotton or lens paper.

If necessary, stubborn stains can be removed by moistening part of a cloth with water to enhance its cleaning power.

6 SPECIFICATIONS

L66 (Desktop Stand Type)

Electrical Specifications

LCD Panel	46 cm (18.1 inch), TFT color LCD panel 0.28 mm dot pitch, Anti-Glare Hard Coating
Viewing Angle	Horizontal: 140°, Vertical: 110° (at Contrast Ratio > 5)
Scan Frequency	
Horizontal:	30 kHz-82 kHz (Automatic)
Vertical:	50 Hz-85 Hz (Automatic) (1280 x 1024: up to 75 Hz)
Viewable Image Size	359 mm (H) x 287 mm (V) (14.1" (H) x 11.3" (V)) (Viewable Image Size: 459 mm (18.07"))
Power Supply	100-120/220-240 VAC ±10%, 50/60Hz, 0.8/0.4 A
Power Consumption	
Normal/Max:	48 W/75 W (with USB hub and the EIZO optional peripheral attached)
Power Saving Mode:	Less than 3 W (When the USB hub is not connected)
Input Connector	2 x D-Sub mini 15-pin
Display Colors	16 million colors
Recommended Resolution	1280 dots x 1024 lines
Input Signal	
Sync:	<ul style="list-style-type: none">• H/V Separate, TTL, Positive/Negative• H/V Composite, TTL, Positive/Negative• Sync on Green 0.3 Vp-p, Negative• Analog 0.7 Vp-p/75 Ω, Positive
Video:	
Dot Clock (Max.):	135 MHz (Normal Mode*) *See page 53.
Plug & Play	VESA DDC1/2B

Mechanical Specifications

Dimensions	430 mm (W) x 455 mm (H) x 198 mm (D) (16.9" (W) x 17.9" (H) x 7.8" (D))
Weight	9.5 kg (20.9 lbs.)

USB Specifications

USB standard	Rev. 1.0 complied self-powered hub
Downstream power supply	500 mA for each (Max.)
Communication speed	12 Mbps (full), 1.5 Mbps (low)
USB ports	Upstream port x 1, Downstream ports x 4

Environmental Specifications

Temperature	Operating: 0°C to 35°C (32°F to 95°F) Storage: -20°C to 60°C (-4°F to 140°F)
Humidity	30% to 80% R.H. Non-condensing

Certifications and Standards

100-120 VAC range	UL/C-UL, FCC class B, TÜV Rheinland Ergonomics Approved, TCO'99 (excluding black-cabinet L66), EPA ENERGY STAR® Program
220-240 VAC range	CE, CB, TÜV Rheinland/GS, TÜV Rheinland/ Ergonomics Approved, TCO'99 (except black-cabinet L66), EPA ENERGY STAR® Program

L66 (Free Mount Type)

Electrical Specifications

LCD Panel	46 cm (18.1 inch), TFT color LCD panel 0.28 mm dot pitch, Anti-Glare Hard Coating
Viewing Angle	Horizontal: 140°, Vertical: 110° (at Contrast Ratio > 5)
Scan Frequency	
Horizontal:	30 kHz-82 kHz (Automatic)
Vertical:	50 Hz-85 Hz (Automatic) (1280 x 1024: up to 75 Hz)
Viewable Image Size	359 mm (H) x 287 mm (V) (14.1" (H) x 11.3" (V)) (Viewable Image Size: 459 mm)
Power Supply (Power Unit)	100-120/220-240 VAC ± 10%, 50/60 Hz, 0.6/0.3 A
Power Consumption	
Normal:	48 W
Max:	57W (with the EIZO optional peripheral attached)
Power Saving Mode:	Less than 3 W
Input Connector	2 x D-Sub mini 15-pin
Display Colors	16 million colors
Recommended Resolution	1280 dots x 1024 lines
Input Signal	
Sync:	<ul style="list-style-type: none"> • H/V Separate, TTL, Positive/Negative • H/V Composite, TTL, Positive/Negative • Sync on Green 0.3 Vp-p, Negative • Analog 0.7 Vp-p/75 Ω, Positive
Video:	
Dot Clock (Max.)	135 MHz (Normal Mode*) *See page 53.
Plug & Play	VESA DDC1/2B

Mechanical Specifications

Dimensions	430 mm (W) x 375 mm (H) x 94 mm (D) (16.9" (W) x 14.8" (H) x 3.7" (D))
Power Unit	269 mm (W) x 50 mm (H) x 120 mm (D) (10.6" (W) x 2.0" (H) x 4.7" (D))
Weight	7.1 kg (15.6 lbs.)
Power Unit	1.2 kg (2.6 lbs.)

Environmental Specifications

Temperature	Operating: 0°C to 35°C (32°F to 95°F) Storage: -20°C to 60°C (-4°F to 140°F)
Humidity	30% to 80% R.H. Non-condensing

Certifications and Standards

100-120 VAC range	UL/C-UL, FCC class B, TÜV Rheinland Ergonomics Approved, TCO'99 (except for black-cabinet L66), EPA ENERGY STAR® Program
220-240 VAC range	CE, CB, TÜV Rheinland/GS, TÜV Rheinland/Ergonomics Approved, TCO'99 (except for black-cabinet L66), EPA ENERGY STAR® Program

APPENDIX
ANHANG
ANNEXE

APPENDIX

Pin Assignment Pin-Belegung Affectation des Broches

2 x D-Sub mini 15 pin connectors

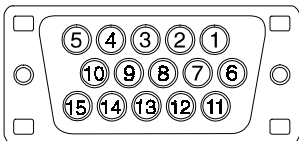

Pin No.	Signal	Pin No.	Signal
1	Red video	9	No pin
2	Green video	10	Ground (shorted)
3	Blue video	11	
4	Ground	12	Data
5	Ground	13	H. Sync
6	Red ground	14	V. Sync
7	Green ground	15	Clock
8	Blue ground	Shell	Ground

USB ports (Desktop Stand Type Only)

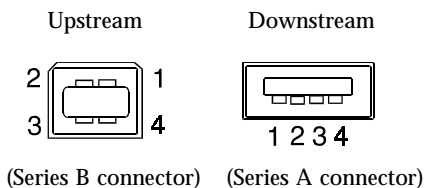

No.	Signal	Comments
1	VCC	Cable power
2	- Data	Serial data
3	+ Data	Serial data
4	Ground	Cable Ground

Preset Timing Chart

Timing-Übersichten

Synchronisation des Signaux

Based on the signal diagram shown below, 18 factory presets have been registered in the monitor's microprocessor.

Der integrierte Mikroprozessor des Monitors unterstützt 18 werkseitige Standardeinstellungen (siehe hierzu die nachfolgenden Diagramme).

18 signaux ont été enregistrés en usine dans le microprocesseur du moniteur, conformément au diagramme de synchronisation ci-dessous.

A	Front Porch	Vordere Schwarzscherle	Front avant
B	Sync Period	Synchronimpuls	Délai de synchronisation
C	Back Porch	Hintere Schwarzscherle	Front arrière
D	Blanking Period	Austastzeit	Délai de clignotement
E	Display period	Display-Zeit	Délai d'affichage
F	Total cycle	Kompletter Zyklus	Cycle total
S	Sync signal level	Sync-Signalpegel	Niveau du signal de synchronisation
V	Video signal level	Video-Signalpegel	Niveau du signal vidéo

A

Mode	Dot Clock	Frequencies		A: Front Porch		B: Sync Period	
		H	V	H µs/Dot	V ms/Line	H µs/Dot	V ms/Line
VGA 640 x 480	25.175 MHz	31.468 kHz	59.941 Hz	0.636/16	0.318/10	3.813/96	0.054/2
VGA 720 x 400	28.322 MHz	31.468 kHz	70.087 Hz	0.636/18	0.381/12	3.813/108	0.064/2
Macintosh 640 x 480	30.24 MHz	35.00 kHz	66.67 Hz	2.116/64	0.086/3	2.116/64	0.086/3
Macintosh 832 x 624	57.28 MHz	49.73 kHz	74.55 Hz	0.559/32	0.020/1	1.117/64	0.060/3
Macintosh 1152 x 870	100.0 MHz	68.68 kHz	75.06 Hz	0.320/32	0.044/3	1.280/128	0.044/3
VESA 640 x 480	31.5 MHz	37.86 kHz	72.81 Hz	0.508/16	0.026/1	1.270/40	0.079/3
VESA 640 x 480	31.5 MHz	37.5 kHz	75.00 Hz	0.508/16	0.027/1	2.032/67	0.080/3
VESA 640 x 480	36.0 MHz	43.27 kHz	85.01 Hz	1.556/56	0.023/1	1.556/56	0.069/3
VESA 800 x 600	36.0 MHz	35.16 kHz	56.25 Hz	0.667/24	0.028/1	2.000/72	0.057/2
VESA 800 x 600	40.0 MHz	37.88 kHz	60.32 Hz	1.000/40	0.026/1	3.200/128	0.106/4
VESA 800 x 600	50.0 MHz	48.08 kHz	72.19 Hz	1.120/56	0.770/37	2.400/120	0.125/6
VESA 800 x 600	49.5 MHz	46.88 kHz	75.00 Hz	0.323/16	0.021/1	1.616/80	0.064/3
VESA 1024 x 768	65.0 MHz	48.36 kHz	60.00 Hz	0.369/24	0.062/3	2.092/136	0.124/6
VESA 1024 x 768	75.0 MHz	56.48 kHz	70.07 Hz	0.320/24	0.053/3	1.813/136	0.106/6
VESA 1024 x 768	78.75 MHz	60.02 kHz	75.03 Hz	0.203/16	0.017/1	1.219/96	0.050/3
VESA 1024 x 768	94.5 MHz	68.68 kHz	85.0 Hz	0.508/48	0.015/1	1.016/96	0.044/3
VESA 1280 x 1024	108.0 MHz	63.98 kHz	60.02 Hz	0.444/48	0.016/1	1.037/112	0.047/3
VESA 1280 x 1024	135.0 MHz	79.97 kHz	75.02 Hz	0.119/16	.013/1	1.067/144	0.038/3

C: Back Porch		D: Blanking Period		E: Display Period		F: Total Cycle	
H μs/Dot	V ms/Line	H μs/Dot	V ms/Line	H μs/Dot	V ms/Line	H μs/Dot	V ms/Line
1.907/48	1.048/33	6.356/156	1.430/45	25.442/640	15.254/480	31.778/800	16.683/525
1.907/54	1.111/35	6356/180	1.556/49	25.422/720	12.712/400	31.778/900	14.267/449
3.175/96	1.114/39	7.407/224	1.286/45	21.164/640	13.714/480	28.571/864	15.000/525
3.911/224	0.784/39	5.586/320	0.865/43	14.524/832	12.549/624	20.111/ 1152	13.414/667
1.440/144	0.568/39	3.040/304	0.655/45	11.520/ 1152	12.667/870	14.560/ 1456	13.322/915
3.810/120	0.528/20	5.587/176	0.634/24	20.317/640	12.678/480	26.413/832	13.735/520
3.810/120	0.427/16	6.349/200	0.533/20	20.317/640	12.800/480	26.667/840	13.333/500
2.222/80	0.578/25	5.333/192	0.670/29	17.778/640	11.093/480	23.111/832	11.764/500
3.556/128	0.626/22	6.222/224	0.711/25	22.222/800	17.067/600	28.444/ 1024	17.778/625
2.200/88	0.607/23	6.400/256	0.739/28	20.000/800	15.840/600	26.400/ 1056	16.579/628
1.280/64	0.478/23	4.800/240	1.373/66	16.000/800	12.480/600	20.800/ 1040	13.853/666
3.232/160	0.448/21	5.172/256	0.533/25	16.162/800	12.800/600	21.333/ 1056	13.333/625
2.462/160	0.600/29	4.923/320	0.786/38	15.754/ 1024	15.880/768	20.677/ 1344	16.666/806
19.20/144	0.513/29	4.053/304	0.673/38	13.653/ 1024	16.599/768	17.707/ 1328	14.272/806
2.235/176	0.466/28	3.657/288	0.533/32	13.003/ 1024	12.795/768	16.660/ 1312	13.328/800
2.201/208	0.524/36	3.825/352	0.582/40	10.836/ 1024	11.183/768	14.561/ 1376	11.765/808
2.296/248	0.594/38	3.778/408	0.656/42	11.852/ 1280	16.005 1024	15.630/ 1688	16.661/ 1066
1.837/248	0.485/38	3.022/408	0.525/42	9.481/1280	12.804/ 1024	12.504/1688	13.329/ 1066

A

Dimensions Abmessungen Dimensions

Desktop Stand Type LCD Monitor

**mm
(inches)**

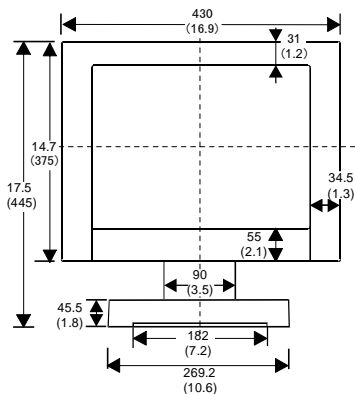

**FRONT VIEW
VORDERANSICHT
VUE DE FACE**

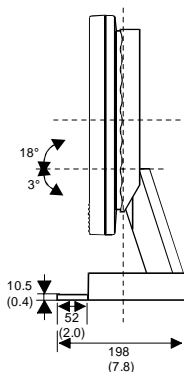

**SIDE VIEW
SEITENANSICHT
VUE DE COTE**

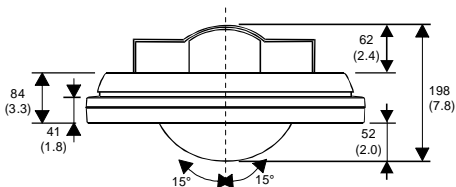

**TOP VIEW
DRAUFSICHT
VUE D'EN HAUT**

Free Mount Type LCD Monitor

**mm
(inches)**

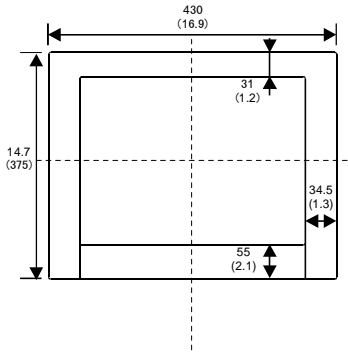

FRONT VIEW
VORDERANSICHT
VUE DE FACE

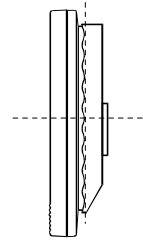

SIDE VIEW
SEITENANSICHT
VUE DE COTE

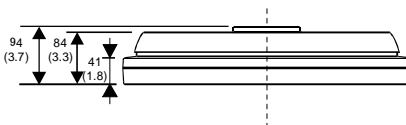

TOP VIEW
DRAUFSICHT
VUE D'EN HAUT

A

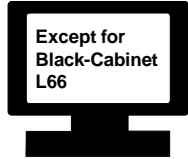

Congratulations!

You have just purchased a TCO'99 approved and labelled product! Your choice has provided you with a product developed for professional use. Your purchase has also contributed to reducing the burden on the environment and also to the further development of environmentally adapted electronics products.

Why do we have environmentally labelled computers?

In many countries, environmental labelling has become an established method for encouraging the adaptation of goods and services to the environment. The main problem, as far as computers and other electronics equipment are concerned, is that environmentally harmful substances are used both in the products and during their manufacture. Since it is not so far possible to satisfactorily recycle the majority of electronics equipment, most of these potentially damaging substances sooner or later enter nature.

There are also other characteristics of a computer, such as energy consumption levels, that are important from the viewpoints of both the work (internal) and natural (external) environments. Since all methods of electricity generation have a negative effect on the environment (e.g. acidic and climate-influencing emissions, radioactive waste), it is vital to save energy. Electronics equipment in offices is often left running continuously and thereby consumes a lot of energy.

What does labelling involve?

This product meets the requirements for the TCO'99 scheme which provides for international and environmental labelling of personal computers. The labelling scheme was developed as a joint effort by the TCO (The Swedish Confederation of Professional Employees), Svenska Naturskyddsforeningen (The Swedish Society for Nature Conservation) and Statens Energimyndighet (The Swedish National Energy Administration).

Approval requirements cover a wide range of issues: environment, ergonomics, usability, emission of electric and magnetic fields, energy consumption and electrical and fire safety.

The environmental demands impose restrictions on the presence and use of heavy metals, brominated and chlorinated flame retardants, CFCs (freons) and chlorinated solvents, among other things. The product must be prepared for recycling and the manufacturer is obliged to have an environmental policy which must be adhered to in each country where the company implements its operational policy.

The energy requirements include a demand that the computer and/or display, after a certain period of inactivity, shall reduce its power consumption to a lower level in one or more stages. The length of time to reactivate the computer shall be reasonable for the user.

Labelled products must meet strict environmental demands, for example, in respect of the reduction of electric and magnetic fields, physical and visual ergonomics and good usability.

Below you will find a brief summary of the environmental requirements met by this product. The complete environmental criteria document may be ordered from:

TCO Development

SE-114 94 Stockholm, Sweden

Fax: +46 8 782 92 07

Email (Internet): development@tco.se

Current information regarding TCO'99 approved and labelled products may also be obtained via the Internet, using the address: <http://www.tco-info.com/>



Except for
Black-Cabinet
L66

Environmental requirements

Flame retardants

Flame retardants are present in printed circuit boards, cables, wires, casings and housings. Their purpose is to prevent, or at least to delay the spread of fire. Up to 30% of the plastic in a computer casing can consist of flame retardant substances. Most flame retardants contain bromine or chloride, and those flame retardants are chemically related to another group of environmental toxins, PCBs. Both the flame retardants containing bromine or chloride and the PCBs are suspected of giving rise to severe health effects, including reproductive damage in fish-eating birds and mammals, due to the bio-accumulative* processes. Flame retardants have been found in human blood and researchers fear that disturbances in foetus development may occur.

The relevant TCO'99 demand requires that plastic components weighing more than 25 grams must not contain flame retardants with organically bound bromine or chlorine. Flame retardants are allowed in the printed circuit boards since no substitutes are available.

Cadmium**

Cadmium is present in rechargeable batteries and in the colour-generating layers of certain computer displays. Cadmium damages the nervous system and is toxic in high doses. The relevant TCO'99 requirement states that batteries, the colour-generating layers of display screens and the electrical or electronics components must not contain any cadmium.

Mercury**

Mercury is sometimes found in batteries, relays and switches. It damages the nervous system and is toxic in high doses. The relevant TCO'99 requirement states that batteries may not contain any mercury. It also demands that mercury is not present in any of the electrical or electronics components associated with the labelled unit.

CFCs (freons)

The relevant TCO'99 requirement states that neither CFCs nor HCFCs may be used during the manufacture and assembly of the product. CFCs (freons) are sometimes used for washing printed circuit boards. CFCs break down ozone and thereby damage the ozone layer in the stratosphere, causing increased reception on earth of ultraviolet light with e.g. increased risks of skin cancer (malignant melanoma) as a consequence.

Lead**

Lead can be found in picture tubes, display screens, solders and capacitors. Lead damages the nervous system and in higher doses, causes lead poisoning. The relevant TCO'99 requirement permits the inclusion of lead since no replacement has yet been developed.

For Europe, etc. (220-240 Vac) Only

CE Marking

Declaration of Conformity

Kind of equipment:	Monitor
Type-designation:	L66 (Model No. FA-1880)

is in compliance with:

Council Directive 73/23/EEC	EN60950:1992+A1+A2+A3+A4	
Council Directive 89/336/EEC	EN55022 (classB):1995	EN50082-1:1992
	EN61000-3-2:1995	EN61000-3-3:1995

Konformitätserklärung

Geräteart :	Monitor
Gerätetyp :	L66 (Modell-Nr. FA-1880)

den folgenden Normen oder Vorschriften entspricht:

EU-Richtlinie 73/23/EEC	EN60950:1992+A1+A2+A3+A4	
EU-Richtlinie 89/336/EEC	EN55022 (classB):1995	EN50082-1:1992
	EN61000-3-2:1995	EN61000-3-3:1995

Déclaration de conformité

Nature de l'équipement :	Moniteur
Type-désignation :	L66 (No. de modèle FA-1880)

est en conformité avec :

Directive Européenne 73/23/EEC	EN60950:1992+A1+A2+A3+A4	
Directive Européenne 89/336/EEC	EN55022 (classB):1995	EN50082-1:1992
	EN61000-3-2:1995	EN61000-3-3:1995

Hinweis zur Ergonomie :

Dieser Monitor erfüllt die Anforderungen an die Ergonomie nach ZH1/618/10.80 durch die Ansteuerung mit der VGA - Videokarte, 1280 Punkte x 1024 Zeilen, RGB analog, 0,7 Vp-p und mindestens 75,0 Hz Bildwiederholfrequenz, (non interlaced).

Weiterhin wird aus ergonomischen Gründen empfohlen, die Grundfarbe Blau nicht auf dunklem Untergrund zu verwenden (schlechte Erkennbarkeit, Augenbelastung bei zu geringem Zeichenkontrast.)

PTB Note

Eigensichere Kathodestranlröhre nach Anlage III Röntgenverordnung. Die in diesem Geraet entstehende Röntgenstrahlung ist durch die eigensichere Kathodenstrahlrohre ausreichend abgeschirmt.

Recycle Auskunft

Die Rücknahme dieses Produktes nach Nutzungsende übernimmt EIZO in Deutschland zusammen mit dem Partner von Roll MBB Recycling GmbH.

Dort werden die Geräte in ihre Bestandteile zerlegt, die dann der Wiederverwertung zugeführt werden. Um einen Abholtermin zu vereinbaren und die aktuellen Kosten zu erfahren, benutzen Sie bitte folgende Rufnummer: 02153-73 35 00. Weitere Informationen finden Sie auch unter der Internet-Adresse: www.eizo.de.

Hinweis

Die Bildrohre dieses Monitors is frei von Cadmium.

For Europe, etc. (220-240 Vac) Only

CE Marking

Declaration of Conformity

Kind of equipment:	Monitor
Type-designation:	L66 (Model No. FA-1881)

is in compliance with:

Council Directive 73/23/EEC	EN60950:1992+A1+A2+A3+A4	
Council Directive 89/336/EEC	EN55022 (classB):1995	EN50082-1:1992
	EN61000-3-2:1995	EN61000-3-3:1995

Konformitätserklärung

Geräteart :	Monitor
Gerätetyp :	L66 (Modell-Nr. FA-1881)

den folgenden Normen oder Vorschriften entspricht:

EU-Richtlinie 73/23/EEC	EN60950:1992+A1+A2+A3+A4	
EU-Richtlinie 89/336/EEC	EN55022 (classB):1995	EN50082-1:1992
	EN61000-3-2:1995	EN61000-3-3:1995

Déclaration de conformité

Nature de l'équipement :	Moniteur
Type-désignation :	L66 (No. de modèle FA-1881)

est en conformité avec :

Directive Européenne 73/23/EEC	EN60950:1992+A1+A2+A3+A4	
Directive Européenne 89/336/EEC	EN55022 (classB):1995	EN50082-1:1992
	EN61000-3-2:1995	EN61000-3-3:1995

Hinweis zur Ergonomie :

Dieser Monitor erfüllt die Anforderungen an die Ergonomie nach ZH1/618/10.80 (GS-VW-SG7/01.97) mit dem Videosignal, 1280 Punkte x 1024 Zeilen, RGB analog, 0,7Vp-p und mindestens 75,0 Hz Bildwiederholfrequenz, (non interlaced).

Der arbeitsplatzbezogene Schalldruckpegel beträgt 70 dB(A) oder weniger gemäß EN 27779.

Dieser Monitor erfüllt die Anforderungen an die Ergonomie nach ZH 1/618/10.80 (GS-VW-SG 7/01.97 mit Ausnahme von Abschnitt 4.5.1.30, welche von dem benutzten Schwenkarm abhängen.)

PTB Note

Eigensichere Kathodestranlröhre nach Anlage III Röntgenverordnung. Die in diesem Gerat entstehende Röntgenstrahlung ist durch die eigensichere Kathodenstrahlrohre ausreichend abgeschirmt.

Recycle Auskunft

Die Rücknahme dieses Produktes nach Nutzungsende übernimmt EIZO in Deutschland zusammen mit dem Partner von Roll MBB Recycling GmbH.

Dort werden die Geräte in ihre Bestandteile zerlegt, die dann der Wiederverwertung zugeführt werden. Um einen Abholtermin zu vereinbaren und die aktuellen Kosten zu erfahren, benutzen Sie bitte folgende Rufnummer: 02153-73 35 00. Weitere Informationen finden Sie auch unter der Internet-Adresse: www.eizo.de.

Hinweis

Die Bildrohre dieses Monitors is frei von Cadmium.

For U.S.A, Canada, etc. (rated 100-120 Vac) Only

FCC Declaration of conformity

We, the Responsible Party

EIZO Nanao Technologies Inc.
5710 Warland Drive, Cypress, CA 90630
Phone: (562) 431-5011

declare that the product

Trade name: EIZO
Model: FlexScan L66 (Desktop Stand Type)
Model No: FA-1880
Model: FlexScan L66 (Free Mount Type)
Model No: FA-1881

is in conformity with Part 15 of the FCC Rules. Operation of this product is subject to the following two conditions: (1) this device may not cause harmful interference, and (2) this device must accept any interference received, including interference that may cause undesired operation.

This equipment has been tested and found to comply with the limits for a Class B digital device, pursuant to Part 15 of the FCC Rules. These limits are designed to provide reasonable protection against harmful interference in a residential installation. This equipment generates, uses, and can radiate radio frequency energy and, if not installed and used in accordance with the instructions, may cause harmful interference to radio communications. However, there is no guarantee that interference will not occur in a particular installation. If this equipment does cause harmful interference to radio or television reception, which can be determined by turning the equipment off and on, the user is encouraged to try to correct the interference by one or more of the following measures.

- *Reorient or relocate the receiving antenna.
- *Increase the separation between the equipment and receiver.
- *Connect the equipment into an outlet on a circuit different from that to which the receiver is connected.
- *Consult the dealer or an experienced radio/TV technician for help.

Changes or modifications not expressly approved by the party responsible for compliance could void the user's authority to operate the equipment.

Note

Use the attached specified shielded cable below or EIZO signal cable with this monitor so as to keep interference within the limits of a Class B digital device.

-AC Cord

-Signal Cable (D-SUB mini 15 pin - D-SUB mini 15 pin, MD-C91)

Canadian Notice

This Class B digital apparatus complies with Canadian ICES-003.

Cet appareil numérique de la classe B est conforme à la norme NMB-003 du Canada.