

# User's Manual

# RadiForce<sup>®</sup>

# G11-S

Monochrome LCD Monitor

## Important

Please read this User's Manual carefully to familiarize yourself with safe and effective usage. Please retain this manual for future reference.

## Wichtig

Bitte lesen Sie dieses Benutzerhandbuch sorgfältig durch, um sich mit der sicheren und effizienten Bedienung vertraut zu machen. Bewahren Sie das vorliegende Handbuch zu Referenzzwecken auf.

## Important

Lisez attentivement le Manuel d'installation afin de vous familiariser avec la sécurité et un usage effectif. Veuillez conserver ce manuel pour référence ultérieure.

## 重要

ご使用前には必ず取扱説明書をよくお読みになり、正しくお使いください。  
この取扱説明書は大切に保管してください。



### For U.S.A, Canada, etc. (rated 100-120 Vac) Only

This equipment has been tested and found to comply with the limits for a Class A digital device, pursuant to Part 15 of the FCC Rules. These limits are designed to provide reasonable protection against harmful interference when the equipment is operated in a commercial environment. This equipment generates, uses, and can radiate radio frequency energy and if not installed and used in accordance with the instruction manual, may cause harmful interference to radio communications. Operation of this equipment in a residential area is likely to cause harmful interference in which case the user will be required to correct the interference at his own expense.

Changes or modifications not expressly approved by the party responsible for compliance could void the user's authority to operate the equipment.

#### Note

Use the attached specified cable below or EIZO signal cable with this monitor so as to keep interference within the limits of a Class A digital device.

- AC Cord
- Shielded Signal Cable (enclosed)

### Canadian Notice

This Class A digital apparatus complies with Canadian ICES-003.

Cet appareil numérique de la classe A est conforme à la norme NMB-003 du Canada.

### For Europe, etc. (rated 200-240 Vac) Only

#### Warning

This is a Class A product. In a domestic environment this product may cause radio interference in which case the user may be required to take adequate measures.

#### Warnung

Bei dem Gerät handelt es sich um ein Klasse-A-Produkt. Bei Betrieb des Geräts in Wohnumgebungen ist gegebenenfalls durch entsprechende Maßnahmen dafür zu sorgen, dass eine Störung des Radio- und Fernsehempfangs vermieden wird.

#### Avertissement

Cet appareil est de classe A. Il est susceptible de créer des interférences radio dans un environnement domestique, dans ce cas l'utilisateur devra prendre les mesures appropriées.

#### Recycle Auskunft

Die Rücknahme dieses Produktes nach Nutzungsende übernimmt EIZO in Deutschland zusammen mit dem Partner eds-r gmbh rücknahmesysteme. Dort werden die Geräte in ihre Bestandteile zerlegt, die dann der Wiederverwertung zugeführt werden. Um einen Abholtermin zu vereinbaren und die aktuellen Kosten zu erfahren, benutzen Sie bitte folgende Rufnummer: 02153-73 35 00. Weitere Informationen finden Sie auch unter der Internet-Adresse: [www.eizo.de](http://www.eizo.de).

#### Recycling Information for customers in Switzerland:

All recycling information is placed in the SWICO's website.

<http://www.swico.ch>

#### Recycling-Information für Kunden in der Schweiz:

Alle Informationen zum Thema Recycling finden Sie auf der Homepage des Branchenverbandes SWICO.

<http://www.swico.ch>

#### Renseignements de recyclage pour les clients en Suisse:

Vous trouvez tous les renseignements pour le sujet de recyclage sur la page WEB de l'UNION DE BRANCHES SWICO.

<http://www.swico.ch>

#### Recycling Information for customers in USA:

All recycling information is placed in the EIZO Nanao Technologies, Inc's website.

<http://www.eizo.com/contact/index.html>

#### Återvinnings information för kunder i Sverige:

All information om återvinning finns på Eizo Europe AB:s hemsida:

[www.eizo.se](http://www.eizo.se)

**User's Manual**

**RadiForce®  
G11-S**

**Monochrome LCD Monitor**

It shall be assured that the final system is in compliance to IEC60601-1-1 requirements.

## SAFETY SYMBOLS

This manual uses the safety symbols below. They denote critical information. Please read them carefully.



### WARNING

Failure to abide by the information in a WARNING may result in serious injury and can be life threatening.



### CAUTION

Failure to abide by the information in a CAUTION may result in moderate injury and/or property or product damage.



Indicates a prohibited action.



Indicates to ground for safety.

- Power supplied equipment can emit electromagnetic waves, that could influence, limit or result in malfunction of the monitor. Install the equipment in a controlled environment, where such effects are avoided.
- This is a monitor intended for use in a medical setting.

---

Copyright© 2004-2008 EIZO NANA O CORPORATION. All rights reserved. No part of this manual may be reproduced, stored in a retrieval system, or transmitted, in any form or by any means, electronic, mechanical, or otherwise, without the prior written permission of EIZO NANA O CORPORATION.

EIZO NANA O CORPORATION is under no obligation to hold any submitted material or information confidential unless prior arrangements are made pursuant to EIZO NANA O CORPORATION's receipt of written information. Although every effort has been made to ensure that this manual provides up-to-date information, please note that EIZO monitor specifications are subject to change without notice.

---

---

DPMS is a trademark and VESA is a registered trademark of Video Electronics Standards Association.

VGA is a registered trademark of International Business Machines Corporation.

Windows is a registered trademark of Microsoft Corporation.

PowerManager and RadiCS are trademarks of EIZO NANA O CORPORATION.

RadiForce, ScreenManager and EIZO are registered trademarks of EIZO NANA O CORPORATION in Japan and other countries.

---

# TABLE OF CONTENTS

 <b>PRECAUTIONS</b> .....	<b>4</b>
<b>1. INTRODUCTION</b> .....	<b>9</b>
1-1. Features .....	9
1-2. Package Contents.....	9
1-3. Controls & Connectors .....	10
<b>2. CABLE CONNECTION</b> .....	<b>12</b>
2-1. Before connecting .....	12
2-2. Connecting the signal cable .....	13
<b>3. ScreenManager</b> .....	<b>16</b>
3-1. How to use the ScreenManager .....	16
3-2. ScreenManager Adjustments and Settings.....	17
3-3. Useful Functions .....	18
<b>4. ADJUSTMENT</b> .....	<b>20</b>
4-1. Screen Adjustment .....	20
4-2. Displaying low resolutions.....	24
4-3. Power-save Setup .....	26
<b>5. MAKING USE OF USB (Universal Serial Bus)</b> .....	<b>27</b>
<b>6. ATTACHING AN ARM STAND</b> .....	<b>29</b>
<b>7. TROUBLESHOOTING</b> .....	<b>31</b>
<b>8. CLEANING</b> .....	<b>35</b>
<b>9. SPECIFICATIONS</b> .....	<b>36</b>
<b>10. GLOSSARY</b> .....	<b>40</b>
<b>MEMO</b> .....	<b>42</b>

# PRECAUTIONS





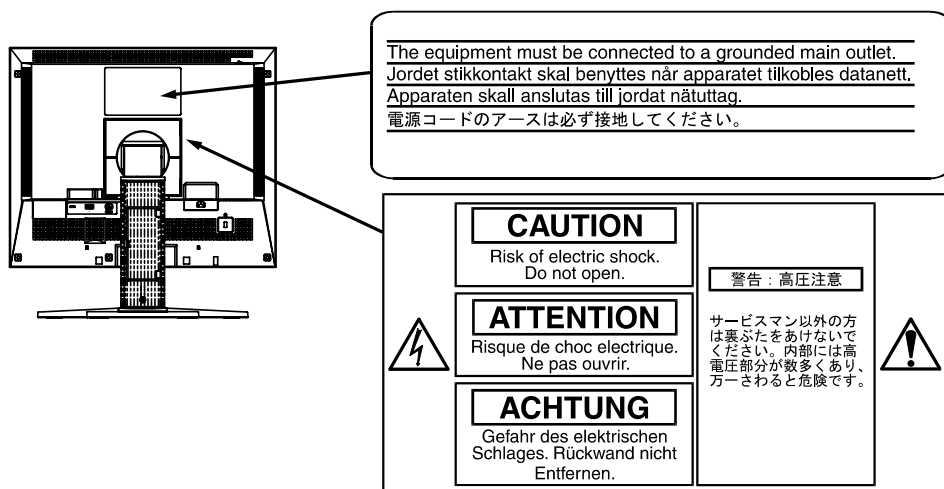

## IMPORTANT!

- This product has been adjusted specifically for use in the region to which it was originally shipped. If operated outside the region to which it was originally shipped, the product may not perform as stated in the specifications.
- To ensure personal safety and proper maintenance, please read this section and the caution statements on the unit (refer to the figure below).

### [Location of the Caution Statements]



### [Symbols on the unit]

Symbol	Location	This symbol indicates
	Top	Main power switch. Press to turn the monitor's main power off.
	Top	Main power switch. Press to turn the monitor's main power on.
	Front Control panel	Power button Press to turn the monitor's power on or off.
	Rear Name Plate	Alternating current
	Rear Name Plate	Alerting electrical hazard
	Rear Name Plate	Caution Refer to SAFETY SYMBOLS section in this manual.

## WARNING

**If the unit begins to emit smoke, smells like something is burning, or makes strange noises, disconnect all power connections immediately and contact your dealer for advice.**

Attempting to use a malfunctioning unit may result in fire, electric shock, or equipment damage.

**Do not open the cabinet or modify the unit.**

Opening the cabinet or modifying the unit may result in fire, electric shock, or burn.



**Refer all servicing to qualified service personnel.**

Do not attempt to service this product yourself as opening or removing covers may result in fire, electric shock, or equipment damage.

**Keep small objects or liquids away from the unit.**

Small objects accidentally falling through the ventilation slots into the cabinet or spillage into the cabinet may result in fire, electric shock, or equipment damage.

If an object or liquid falls/spills into the cabinet, unplug the unit immediately. Have the unit checked by a qualified service engineer before using it again.

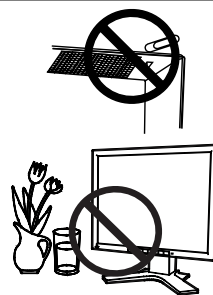

**Place the unit at the strong and stable place.**

A unit placed on an inadequate surface may fall and result in injury or equipment damage.

If the unit falls, disconnect the power immediately and ask your dealer for advice. Do not continue using a damaged unit. Using a damaged unit may result in fire or electric shock.



**Set the unit in an appropriate location.**

Not doing so may result in fire, electric shock, or equipment damage.

- \* Do not place outdoors.
- \* Do not place in the transportation system (ship, aircraft, trains, automobiles, etc.)
- \* Do not place in a dusty or humid environment.
- \* Do not place in a location where the steam comes directly on the screen.
- \* Do not place near heat generating devices or a humidifier.
- \* Do not place in an inflammable gas environment.

**To avoid danger of suffocation, keep the plastic packing bags away from babies and children.**

**Use the enclosed power cord and connect to the standard power outlet of your country.**

Be sure to remain within the rated voltage of the power cord.

Not doing so may result in fire or electric shock.

## **WARNING**

---

**To disconnect the power cord, grasp the plug firmly and pull.**

Tugging on the cord may damage and result in fire or electric shock.

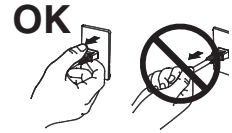

**The equipment must be connected to a grounded main outlet.**

Not doing so may result in fire or electric shock.



**Use the correct voltage.**

- \* The unit is designed for use with a specific voltage only. Connection to another voltage than specified in this User's Manual may cause fire, electric shock, or equipment damage.
- \* Do not overload your power circuit, as this may result in fire or electric shock.

**Handle the power cord with care.**

- \* Do not place the cord underneath the unit or other heavy objects.
- \* Do not pull on or tie the cord.

If the power cord becomes damaged, stop using it. Use of a damaged cord may result in fire or electric shock.



**Never touch the plug and power cord if it begins to thunder.**

Touching them may result in electric shock.



**When attaching an arm stand, please refer to the user's manual of the arm stand and install the unit securely.**

Not doing so may cause the unit to become unattached, which may result in injury or equipment damage. When the unit is dropped, please ask your dealer for advice. Do not continue using a damaged unit. Using a damaged unit may result in fire or electric shock. When reattaching the tilt stand, please use the same screws and tighten them securely.

---



---

 **WARNING**

---

**Do not touch a damaged LCD panel directly with bare hands.**

The liquid crystal that may leak from the panel is poisonous if it enters the eyes or mouth.

If any part of the skin or body comes in direct contact with the panel, please wash thoroughly. If some physical symptoms result, please consult your doctor.

**Follow local regulation or laws for safe disposal.**

The backlight of the LCD panel contains mercury.

---

---

 **CAUTION**

---

**Handle with care when carrying the unit.**

Disconnect the power cord and cables when moving the unit. Moving the unit with the cord attached is dangerous. It may result in injury.

**When handling the unit, grip the bottom of the unit firmly with both hands ensuring the panel faces outward before lifting.**

Dropping the unit may result in injury or equipment damage.

**Do not block the ventilation slots on the cabinet.**

- \* Do not place any objects on the ventilation slots.
- \* Do not install the unit in a closed space.
- \* Do not use the unit laid down or upside down.

Blocking the ventilation slots prevents proper airflow and may result in fire, electric shock, or equipment damage.

**Do not touch the plug with wet hands.**

Doing so may result in electrical shock.

**Use an easily accessible power outlet.**

This will ensure that you can disconnect the power quickly in case of a problem.

**Periodically clean the area around the plug.**

Dust, water, or oil on the plug may result in fire.

---

## CAUTION

---

---

### **Unplug the unit before cleaning it.**

Cleaning the unit while it is plugged into a power outlet may result in electric shock.

---

**If you plan to leave the unit unused for an extended period, disconnect the power cord from the wall socket after turning off the power switch for the safety and the power conservation.**

---

## **LCD Panel**

---

---

In order to suppress the luminosity change by long-term use and to maintain the stable luminosity, please use the monitor with the brightness below 400 cd/m<sup>2</sup> (equal to default setting of Brightness approximately 60 %).

---

The screen may have defective pixels. These pixels may appear as slightly light or dark area on the screen. This is due to the characteristics of the panel itself, and not the product.

---

The backlight of the LCD panel has a fixed life span. When the screen becomes dark or begins to flicker, please contact your dealer.

---

Do not press on the panel or edge of the frame strongly, as this may result in damage to the screen. There will be prints left on the screen if the pressed image is dark or black. If pressure is repeatedly applied to the screen, it may deteriorate or damage your LCD panel. Leave the screen white to decrease the prints.

---

Do not scratch or press on the panel with any sharp objects, such as a pencil or pen as this may result in damage to the panel. Do not attempt to brush with tissues as this may scratch the LCD panel.

---

When the screen image is changed after displaying the same image for extended periods of time, an afterimage may appear. Use the screen saver or timer to avoid displaying the same image for extended periods of time.

---

When the monitor is cold and brought into a room or the room temperature goes up quickly, dew condensation may occur inside and outside the monitor. In that case, do not turn the monitor on and wait until dew condensation disappears, otherwise it may cause some damages to it.

---

---

# 1. INTRODUCTION

Thank you very much for choosing an EIZO Monochrome Monitor.

## 1-1. Features

- DVI (p. 40) Digital input (TMDS (p. 41)) compliant
- Resolution: 1 M pixels (1280 x 1024)  
Horizontal scanning frequency: 27 - 82 kHz (Digital input: 27 - 64 kHz)  
Vertical scanning frequency: 50 - 85 Hz (1280 x 1024 ~ 75 Hz)  
(Digital input: 60 Hz (VGA text: 70 Hz))
- RGB Color video signal compatibility
- Auto Adjustment compliant
- USB (Universal Serial Bus) hub supported (p.27)
- The height adjustable stand incorporated
- Ultra slim bezel incorporated
- The Portrait/Landscape display capability

## 1-2. Package Contents

Please contact your local dealer for assistance if any of the listed items are missing or damaged.

- LCD Monitor
- Power Cord
- Signal Cable (FD-C16)
- Signal Cable (FD-C04 / FD-C35 / FD-C39)
- EIZO USB Cable (MD-C93)
- User's Manual
- LIMITED WARRANTY

### **NOTE**

- Please retain the packing materials for future transference.

# 1-3. Controls & Connectors

## Front

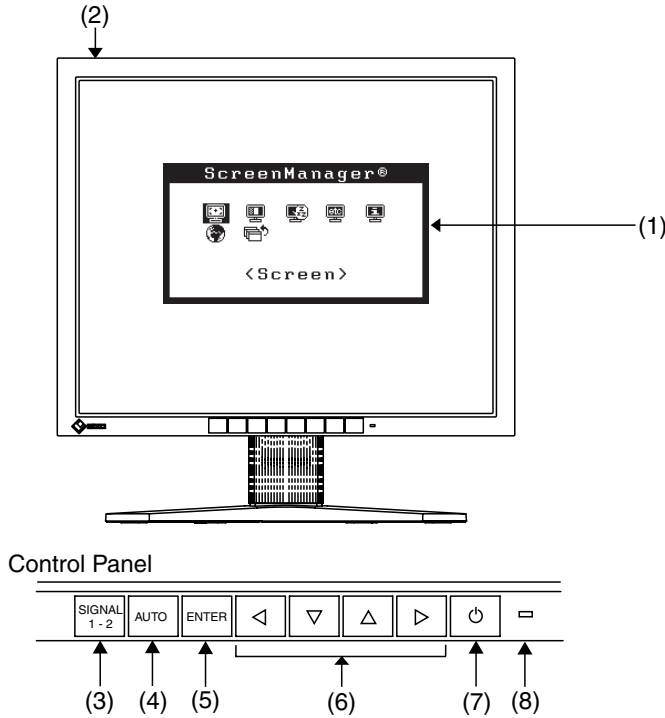

- (1) ScreenManager®
- (2) IO Main Power Switch
- (3) SIGNAL 1-2 Signal selection button (Color/Monochrome)<sup>1</sup>
- (4) AUTO Auto Adjustment Button
- (5) ENTER Enter Button
- (6) ◀▶▲▼ Control Buttons (Left, Down, Up, Right)<sup>2</sup>
- (7) ⏻ Power Button
- (8) ◻ Power Indicator<sup>3</sup>

Green	Operating
Orange	Power saving
Flashing orange (2 times for each)	Power save mode Digital only
Flashing orange slowly	Power is off (Main power is on)
Off	Power off

<sup>1</sup> Select color or monochrome for the graphics board of use (p.14).

<sup>2</sup> These buttons are changed to Down, Right, Left, Up in case of selecting “Portrait” for <Orientation> of ScreenManager <Others> (p.17).

<sup>3</sup> Green lighting, when the screen is displayed (Operation mode), is made to non-light, see page 17.





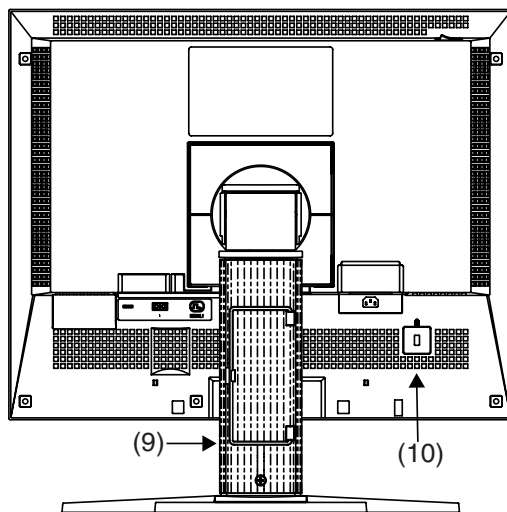

Regarding the power indicator for the off timer, see page 18.

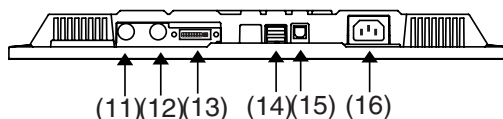
## Rear



Bottom



- (9) Height Adjustable Stand (Detachable)<sup>\*4</sup>
- (10)  Security Lock Slot<sup>\*5</sup>
- (11)  SENSOR Serial Port (Mini DIN 8 pin) (for factory use)
- (12)  IN Serial Port (Mini DIN 6 pin) (for factory use)
- (13)  DVI-I Input Connector
- (14)  USB Port (2 Downstream)
- (15)  USB Port (1 Upstream)
- (16)  Power Connector

<sup>\*4</sup> The LCD monitor has the capability of the Portrait/Landscape display. (The panel pivots in the counter-clockwise direction 90°.)

The LCD monitor can be used with an optional arm stand by removing the stand. (see page 29)

<sup>\*5</sup> Allows for connection of a security cable. This lock supports Kensington's MicroSaver security system.

## 2. CABLE CONNECTION

### 2-1. Before connecting

Before connecting your monitor to the PC, change the display screen settings (resolution p. 41) and frequency) in accordance with the charts below.

#### **NOTE**

- When your computer and display support VESA DDC, the suitable resolution and the refresh rate are set by just plugging your display into the computer without any manual settings.

#### Analog Input

Resolution	Frequency	Dot Clock	Remarks
640 × 480	~ 85 Hz	~ 135 Hz	VGA, VESA
720 × 400	70 Hz		VGA TEXT
800 × 600	~ 85 Hz		VESA
832 × 624	75 Hz		Apple Macintosh
1024 × 768	~ 85 Hz		VESA
1152 × 864	75 Hz		VESA
1152 × 870	75 Hz		Apple Macintosh
1152 × 900	~ 76 Hz		SUN WS
1280 × 960	60 Hz		VESA
1280 × 960	75 Hz		Apple Macintosh
1280 × 1024	67 Hz		SUN WS
1280 × 1024	~ 75 Hz		VESA

#### Digital Input

Resolution	Frequency	Dot Clock	Remarks
640 × 480	60 Hz	~ 108 Hz	VGA
720 × 400	70 Hz		VGA TEXT
800 × 600	60 Hz		VESA
1024 × 768	60 Hz		VESA
1280 × 1024	60 Hz		VESA

## 2-2. Connecting the signal cable

### NOTE

- Be sure that the power switches of both the PC and the monitor are OFF.

1. Plug the signal cable into the connector at the rear of the monitor and the other end of the cable into the video connector on the PC.

After connecting, secure the connection with the screw-in fasteners.

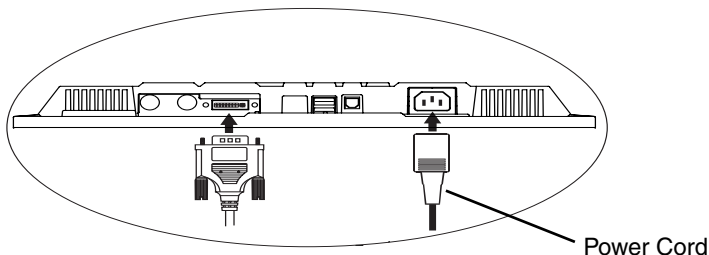

### Analog Input

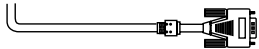
Signal Cable	Connector	PC
Signal Cable (FD-C16 enclosed) 	Video Output Connector D-Sub mini 15 pin	Analog graphics board

### [BNC cable]

BNC connection is available when using the optional adapter.

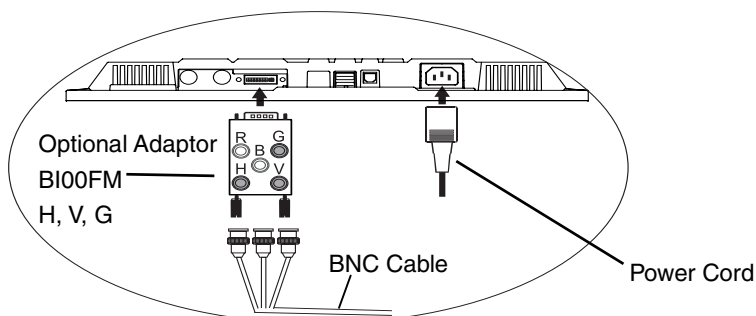

Signal Cable	Connector	PC
RadiForce BNC Adaptor BI00FM (Optional) + BNC cable	Video Output Connector /Analog	Analog graphics board

### NOTE

- In case of connecting to the monochrome graphics card, choose "Monochrome" by the signal select button on the front panel.

**[Signal selection]**

Please use the signal select button on the front panel.

- (1) The selection menu appears by pressing the button for more than 2 seconds.
- (2) Choose “Monochrome” by up and down keys.

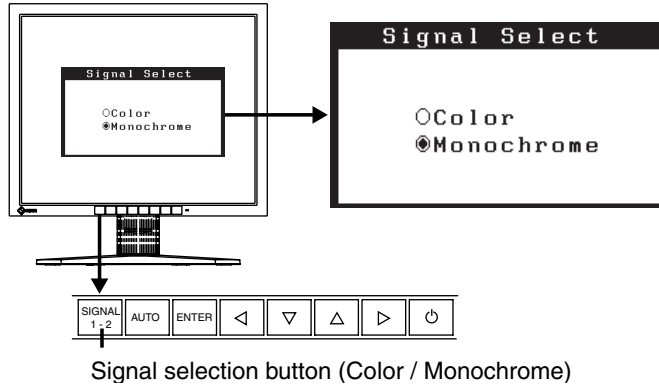

**Digital Input**

Signal Cable	Connector	PC
Signal Cable (FD-C04 / FD-C35 / FD-C39 enclosed) 	Video Output Connector DVI	Monochrome digital graphics board

**NOTE**

- Only TMDS DATA1 (Green) of video signal data is displayed.
- The monitor is not compatible with a color digital graphics board.

- 2.** Plug the power cord into the power connector on the rear of the monitor.
- 3.** Lead the power cord and signal cable into the cable holder at rear of the monitor.

**NOTE**

- The cables are recommended to lead with slight sag for the smooth motion of the stand.



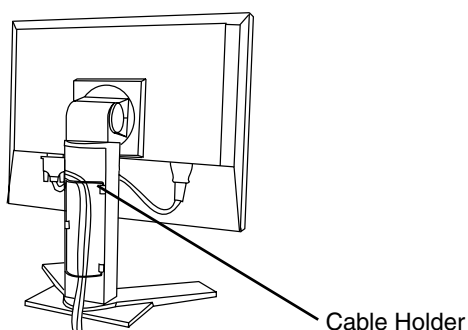

#### 4. Plug the other end of the power cord into a power outlet.

### **WARNING**

**Use the enclosed power cord and connect to the standard power outlet of your country.**

Be sure to remain within the rated voltage of the power cord.

Not doing so may result in fire or electric shock.

**The equipment must be connected to a grounded main outlet.**

Not doing so may cause in fire or electric shock. Not doing so may result in fire or electric shock.



#### 5. Turn on the monitor's main power and then switch on the PC's power.

The monitor's power indicator will light up (green).

If an image does not appear, refer to the "7. TROUBLESHOOTING" (p.31) for advice.

Whenever finished, turn off the PC and the monitor.

### **NOTE**

- When turning on the monitor, the kind of the input signal (Analog or Digital) is displayed for a few seconds on the right top corner of the screen.
- Adjust brightness of the screen depending on the brightness of your environment.
- Be sure to take adequate rests. A 10-minute rest period each hour is suggested.

#### 6. When using the optional calibration kit (p.37), connect the upstream port of the monitor to the downstream port of the USB compliant PC with the USB cable.

For further details about the calibration, refer to user's manual in the calibration kit.

# 3. ScreenManager

## 3-1. How to use the ScreenManager

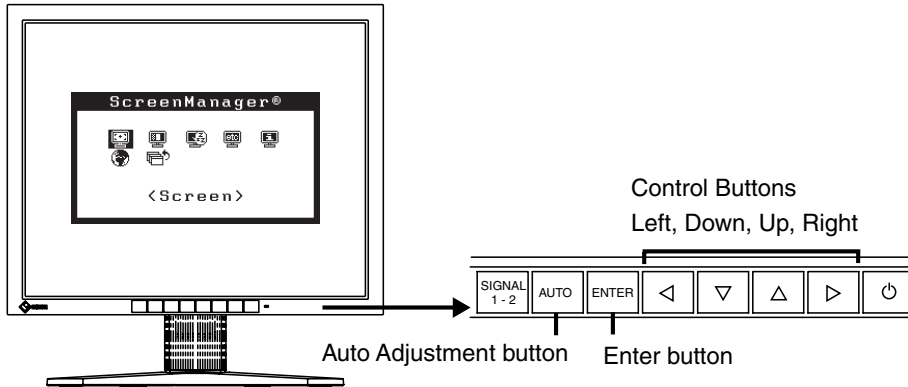

### 1. Entering the ScreenManager

Push the Enter button once to display the main menu of the ScreenManager.

[Main Menu]



### 2. Making Adjustments and Settings

- (1) Select the desired sub menu icon using the Control buttons and push the Enter button. The sub menu appears.
- (2) Use the Control buttons to select the desired setting icon and push the Enter button. The setting menu appears.
- (3) Use the Control buttons to make all required adjustments and push the Enter button to save the settings.

### 3. Exiting the ScreenManager

- (1) To return to the main menu, select the <Return> icon or push the down button twice, followed by the Enter button.
- (2) To exit the ScreenManager, select the <Exit> icon or push the down button twice, followed by the Enter button.

#### **NOTE**

- Double clicking the Enter Button also exits the ScreenManager menu.

## 3-2. ScreenManager Adjustments and Settings.

The following table shows all the ScreenManager's adjustment and setting menus.  
 “\*” indicates adjustments of analog input only and “\*\*” indicates digital input only.

Main menu	Sub menu	Reference	
Screen	Clock	*	
	Phase	*	
	Position		
	Resolution		
	Range Adjustment	*	
	Brightness		
	Smoothing		
	Signal Filter	*	
	Unlock		
LUT Setting	Default / Normal <sup>1</sup> / Custom <sup>2</sup>		
PowerManager	VESA DPMS	*	
	DVI DPM	**	
Others	Screen Size		
	Border Intensity		
	Off Timer		
	Menu Settings	Menu Size	
		Menu Position	
		Menu Off Timer	
		Translucent	
	Orientation		
	ID		
	Power Indicator		
Reset			
Information	Information		
Language	English and Japanese		

<sup>1</sup>Set to the “Normal” in case of using the monitor with the characteristic of panel original.

<sup>2</sup>“Custom” automatically stores the customized data after the calibration is performed.

<sup>3</sup>Due to the inspection on the factory, the usage time may not “0 hour” at shipping.

## 3-3. Useful Functions

### Adjustment Lock

Use the “Adjustment Lock” function to prevent any accidental changes.

Locked function	<ul style="list-style-type: none"> <li>• Settings in the ScreenManager.</li> <li>• Signal selection button (Color/Monochrome)</li> </ul>
Unlocked function	<ul style="list-style-type: none"> <li>• Adjustment of brightness by the control buttons.</li> </ul>

#### [How to lock]

- (1) Switch off the monitor’s power by the power button on the front panel.
- (2) Press on the Auto adjustment button while switching on the monitor’s power.

#### [How to unlock]

- (1) Switch off the monitor’s power by the power button on the front panel
- (2) Hold down the Auto adjustment button once again and turn the power back on.

### Off Timer

The off timer function causes the monitor to automatically enter a power off state after a predetermined amount of time has lapsed. This function was created to reduce afterimage characteristics that are particular to LCD monitors when the monitor screen is left on for a long period without use.

#### [Procedure]

- (1) Select <Off Timer> in the ScreenManager <Others> menu.
- (2) Select “Enable” and press the right and left buttons to adjust the “On Period” (1 to 23 hours).

#### [Off timer system]

PC	Monitor	Power Indicator
On Period (1H - 23H)	Operation	Green
Last 15 min. in "On period"	Advance Notice <sup>1)</sup>	Green Flashing
"On period" expired	Power off	Flashing orange slowly

<sup>1)</sup>Advance notice (LED flashing green) will be given 15 minutes before the monitor automatically enters the “Power Off” mode. To delay entering the “Power Off” mode, press the Power button during the advance notice period. The monitor will continue to operate for an additional 90 minutes.

#### [Procedure]

Press the power button to return to a normal screen.

#### **NOTE**

- The off timer function works while the PowerManager is active, but there is no advance notice before the monitor’s power is switched off.

## Unlock function after calibration

The calibration is available when using the specified optional calibration kit (p.37).  
After the calibration, the functions below are automatically locked.

Locked function	<ul style="list-style-type: none"> <li>• Brightness adjustment (including the adjustment by left and right buttons on the front panel)</li> <li>• Range adjustment</li> <li>• LUT Setting</li> <li>• Signal selection button (Color / Monochrome)</li> </ul>
-----------------	--

Unlock function is available by using ScreenManager.

### [How to unlock]

- (1) Select the <Unlock> of <Screen> menu.
- (2) Select “Unlock”.

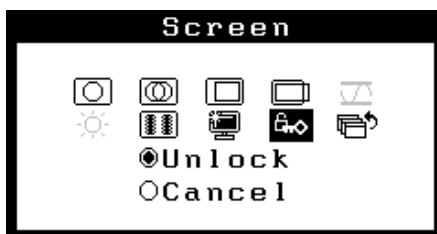

### NOTE

- Performing the <Reset> of <Others>, locked functions above are also unlocked.

# 4. ADJUSTMENT

## 4-1. Screen Adjustment

**NOTE**

- Allow the LCD monitor to stabilize for at least 30 minutes before making image adjustments.

**When connecting the digital graphics board, see page 23.**

### Analog Input

Screen adjustments for the LCD monitor should be used in suppressing screen flickering and also for adjusting the screen to its proper position. There is only one correct position for each display mode. It is also recommended to use the ScreenManager function when first installing the display or whenever changing the system.

### Adjustment Procedure

#### 1. Push the Auto adjustment button on the front panel.

The message “Your setting will be lost, if you press again now.” appears and remains on the screen for 5 seconds. While the message is on the screen, push the Auto adjustment button again to automatically adjust the clock, phase, screen position and resolution. If you do not wish to do adjust the screen, do not push the Auto adjustment button again.

**NOTE**

- The Auto sizing function is intended for use on the Macintosh and on AT-compatible PC running Windows. It may not work properly in either of the following cases.
  - When running an AT-compatible PC on MS-DOS (Not windows).  
The background color for the “wall paper” or “desktop” pattern is set to black.
- Some signals from a graphics board may not function properly.

**If the appropriate screen cannot be made by using the Auto adjustment button, adjust the screen through the following procedures. If the appropriate screen can be made, proceed to step 4.**

#### 2. We recommend setting the desktop pattern to that as shown in the diagram below.

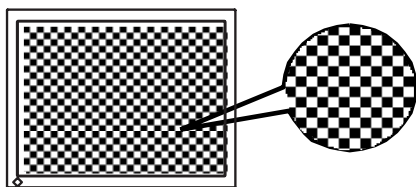
**NOTE**

- More precise adjustment is available for using the “Screen Adjustment program” utility software. It can be downloaded from the EIZO homepage (<http://www.eizo.com/>).

### 3. Adjust by using <Screen> menu in the ScreenManager.

#### (1) Vertical bars appear on the screen

→  Use the <Clock> (p.40) adjustment.

Select the “Clock” and eliminate the vertical bars by using the right and left of the control buttons. Do not continuously press the control buttons, as the adjustment value will change quickly and make it difficult to locate the most suitable adjustment point.

If the horizontal flickering, blur or bars appear, proceed to “Phase” adjustment as follows.

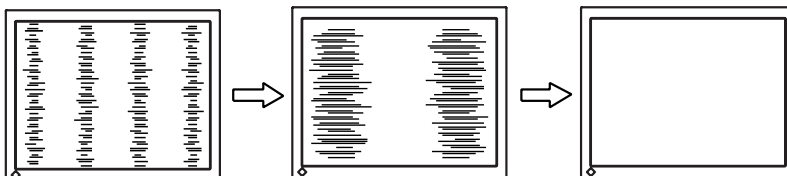
**NOTE**

- When adjusting the <Clock>, the horizontal screen size will also change.

#### (2) Horizontal flickering, blurring or bars appear on the screen.

→  Use the <Phase> (p.40) adjustment.

Select the <Phase> and eliminate the horizontal flickering, blurring or bars by using the right and left buttons.

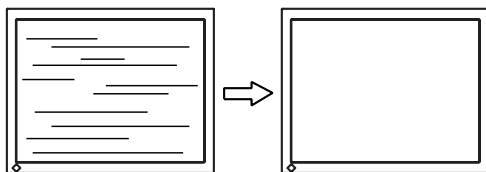
**NOTE**

- Horizontal bars may not completely disappear from the screen depending on the PC.

(3) The screen position is incorrect.

→  Use the <Position> adjustment.

The correct displayed position of the monitor is decided because the number and the position of the pixels are fixed. The <Position> adjustment moves the image to the correct position.

Select <Position> and adjust the position of the upper left corner of the image by using the up, down, right and left buttons in order to align the screen.

If vertical bars of distortion appear after finishing the <Position> adjustment, return to <Clock> adjustment and repeat the previously explained adjustment procedure (“Clock” → “Phase” → “Position”)

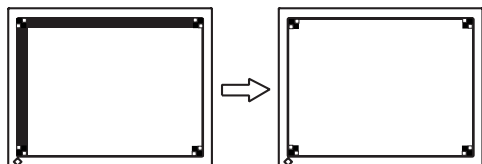

(4) Screen image is smaller or larger than the actual screen images.

→  Use the <Resolution> adjustment.

Adjustment is needed when the input signal resolution and the resolution now being displayed are different.

Select <Resolution> and confirm if the resolution now being displayed is the same as the input resolution. If it is not, adjust the vertical resolution using the up and down button and adjust the horizontal resolution using the right and left buttons.

Smaller than the actual screen images.

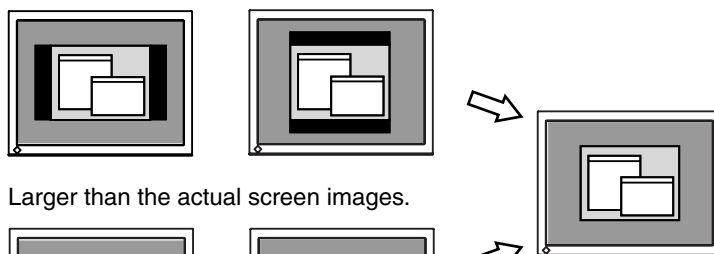

Larger than the actual screen images.

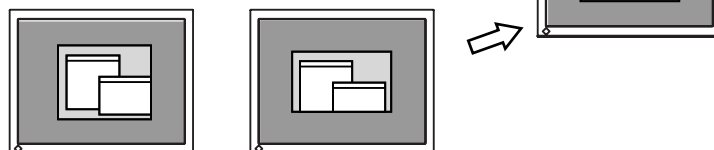



#### 4. Adjust the output signal range (Dynamic Range) of the signal.

→  Use the <Range Adjustment> (p.40) of <Screen> menu.

This controls the level of output signal range to display the whole gradation (256 steps).

##### [Procedure]

Push the Auto adjustment button on the front panel while displaying the <Range Adjustment> menu to automatically adjust the range. The screen blanks for a moment, and adjusts the color range to display the whole gradation of the current output signal.

#### 5. Set the Brightness of the screen.

→  Use the <Brightness> adjustment.

The brightness of the entire screen is controlled by changing the brightness of the backlight.

Select <Brightness> in the <Screen> menu and adjust by using the right and left buttons.

##### **NOTE**

- Directly pressing the control buttons also adjusts the brightness. Press the Enter button to save and exit the settings after the adjustment.

## Digital input

The monitor displays the digital input image correctly based on its pre-setting data. However, if the image position is not correct or larger than the actual image screen, please adjust the following adjustment items using the <Screen> menu of the ScreenManager.

#### 1. The screen position is incorrect.

→  Use the <Position> adjustment.

See p.22.

#### 2. Screen image is smaller or larger than the actual screen images.

→  Use the <Resolution> adjustment.

See p.22.

#### 3. Set the Brightness of the screen.

→  Use the <Brightness> adjustment.

See p.23.

## 4-2. Displaying low resolutions

Using the <Screen Size> function in the <Others> menu enables to change the screen size of lower resolution (i.e. except 1280 x 1024).

### 1. Enlarge the screen size when displaying a low resolution.

→  Select the <Screen Size>.

Select the <Screen Size> in the <Others> menu and select the screen size by using the up and down buttons.

Menu	Function
Full Screen	Displays the picture on the screen in full, irrespective of the picture's resolution. Since the vertical resolution and the horizontal resolution are enlarged at different rates, some images may appear distorted.
Enlarged	Displays the picture on the screen in full, irrespective of the picture's resolution. Since the vertical resolution and horizontal resolution are enlarged at same rates, some horizontal or vertical image may disappear.
Normal	Displays the picture at the actual Screen resolution.

Example: Displaying 1024 x 768

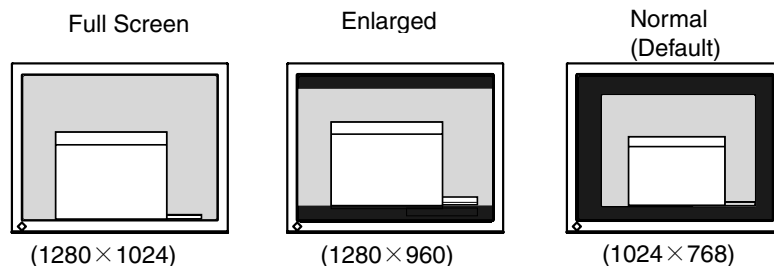

### 2. Smooth the blurred texts of the enlarged screen.

→  Switch the <Smoothing> setting.

Select the suitable level from 1 – 5 (Soft – Sharp).

Select <Smoothing> in the <Screen> menu and adjust by using the right and left buttons.

#### NOTE

- <Smoothing> is disabled when the screen is displayed in the following resolutions.
  - \*1280 x 1024
  - \*The image size is doubled both in horizontally and vertically to (i.e. 1280 x 960 enlarged from 640 x 480) provide clear focus which does not require this function.

- 3.** Set the brightness of the black area surrounding the displayed image.  
→  Set the <Border Intensity>.

In the <Enlarge> mode or <Full Screen> mode, the outer area (border) is usually black.

Select <Border Intensity> in the <Others> menu and adjust by using the right and left buttons.

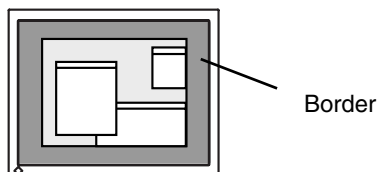

## 4-3. Power-save Setup

The <PowerManager> menu in the ScreenManager enables to set the power-save setup.

### NOTE

- Do your part to conserve energy, turn off the monitor when you are finished using it. Disconnecting the monitor from the power supply is recommended to save energy completely.
- Even if the monitor is in a power saving mode, USB compliant devices function when they are connected to the monitor's USB (both the upstream and the downstream ports). Therefore, power consumption of the monitor will change according to the connected devices even if the monitor is in a power saving mode.

### Analog input

This monitor complies with the “VESA DPMS” (p.41).

#### [Procedure]

- (1) Set the PC's power saving settings.
- (2) Select “VESA DPMS” in the <PowerManager> menu.

#### [Power saving system]

PC		Monitor	Power Indicator
Operation		Operation	Green
Power saving	STAND-BY SUSPEND OFF	Power saving	Orange

#### [Power Resumption Procedure]

Operate the mouse or keyboard to return to a normal screen.

### Digital input

This monitor complies with the DVI DMPM (p.40).

#### [Procedure]

- (1) Set the PC's power saving settings.
- (2) Select “DVI DMPM” in the <PowerManager> menu.

#### [Power saving system]

PC	Monitor	Power Indicator
Operation	Operation	Green
Power saving	Power saving	Orange
Off mode	Power saving	Flashing orange (2 times for each)

#### [Power Resumption Procedure]

Operate the mouse or keyboard to return to a normal screen.

Power on the PC to return a normal screen from the off mode of the PC.

# 5. MAKING USE OF USB (Universal Serial Bus)

This monitor provides a hub which supports the USB standard. When connecting to a USB compliant PC or another hub, the monitor functions as a hub to which the USB compliant peripherals can be easily connected.

## Required system environment

- PC equipped with USB ports or another USB hub connected to the USB compliant PC
- EIZO USB Cable (MD-C93)

### NOTE

- The USB hub function may not work properly depending on the PC, OS or peripherals. Please consult the manufacturer of each device about the USB support.
- When the monitor is not on, the peripherals connected to the downstream ports will not operate.
- Even if the monitor is in a power saving mode, the devices connected to the monitor's USB ports (both the upstream and the downstream) will function.

## Connecting to the USB HUB

1. Connect the monitor to the PC with the signal cable (P. 13) first, and then turn on the PC.
2. Connect the upstream port of the monitor to the downstream port of the USB compliant PC or another hub by using the USB cable.

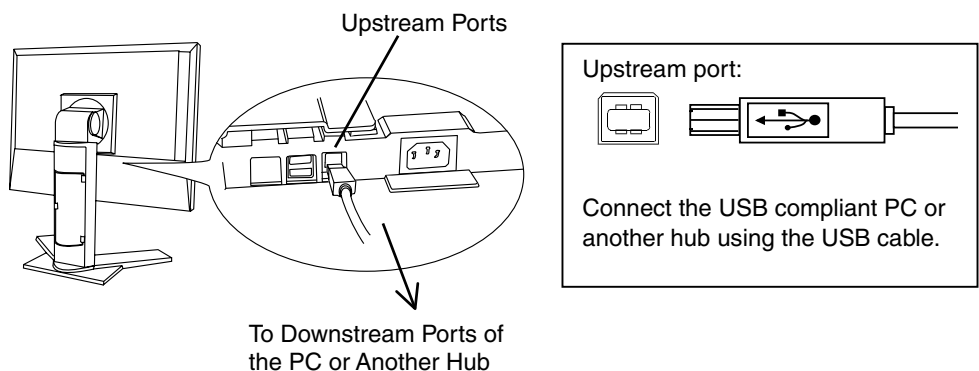

After connecting the USB cable, the USB function can be set up automatically.

3. After setting up, the monitor's USB hub is available for connecting USB compliant peripherals to the downstream ports of the monitor.

### Connecting Examples

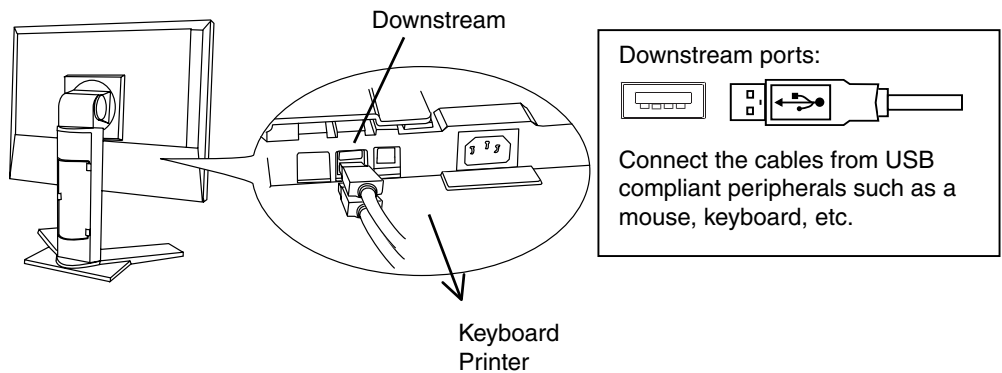
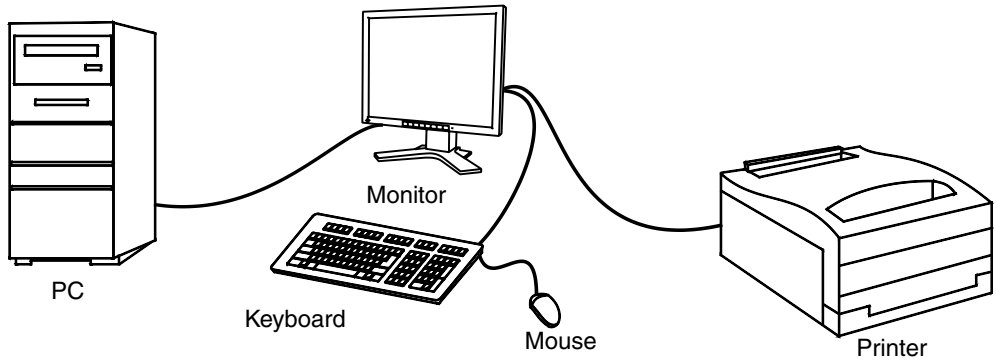

# 6. ATTACHING AN ARM STAND

The LCD monitor can be used with an arm or stand by removing the tilt stand and attaching the arm stand to the LCD monitor.

## NOTE

- If you will use the arm or stand of other manufacturers, confirm the followings to the manufacturers before selecting.
  - Hole spacing on the arm mounting: 100 mm x 100 mm (VESA compliant)
  - Supportable Weight: Total weight of the monitor (without stand) and attaching equipment such as a cable
  - TÜV/GS approved arm or stand
- Please connect cables after attaching an arm stand.

## Setup Procedure

1. Pivot the panel in the counter-clockwise to fix in portrait position.
2. Hold the center of the stand mounting cover and slide them rightward or leftward to remove the mounting cover.

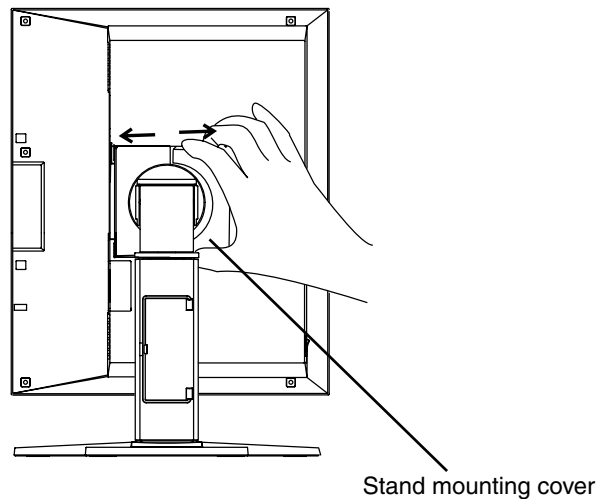

3. Lay the LCD monitor down. Do not scratch the panel.
4. Remove the tilt stand by loosening the screws. (4 pcs of M4 x 15 mm)
5. Attach an arm stand to the LCD monitor securely.

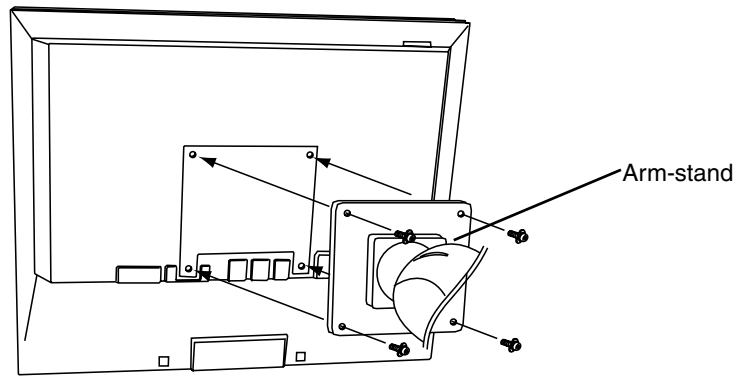

4 Mounting Screws: M4 x 15 (mm)





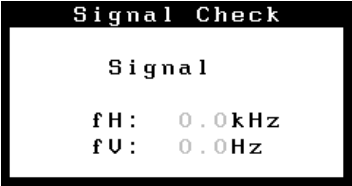
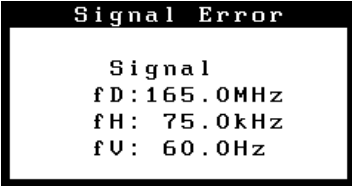

# 7. TROUBLESHOOTING

If a problem persists even after applying the suggested remedies, contact an EIZO dealer.

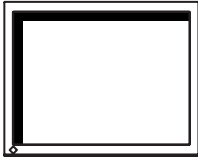
- No picture problems → See No.1 ~ No.2
- Imaging problems → See No.3 ~ No.13
- Other problems → See No.14 ~ No.17
- USB problems → See No.18 ~ No.19

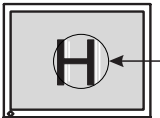
Problems	Points to check with possible solutions
<p><b>1. No picture</b></p> <ul style="list-style-type: none"> <li>• Indicator status: Off</li> </ul>	<ul style="list-style-type: none"> <li><input type="checkbox"/> Check that the power cord is correctly connected. If the problem persists, turn off the monitor power for a few minutes, then turn it back on and try again.</li> </ul>
<ul style="list-style-type: none"> <li>• Indicator status: Green</li> <li>• Indicator status: Orange</li> <li>• Indicator status: Slowly flashing Orange</li> <li>• Indicator status: Flashing Orange (twice for each)</li> </ul>	<ul style="list-style-type: none"> <li><input type="checkbox"/> Check the “Brightness” settings.</li> <li><input type="checkbox"/> Try pressing a key on the keyboard, or clicking the mouse. (p.26)</li> <li><input type="checkbox"/> Try pressing the power button.</li> <li><input type="checkbox"/> Try turning the PC on.</li> </ul>
<p><b>2. Error messages shown below will remain on the screen for 40 seconds.</b></p> 	<p>These messages appear when the signal is not inputted correctly, even if the monitor functions properly.</p> <ul style="list-style-type: none"> <li><input type="checkbox"/> When the image is displayed correctly after a short time, there is no problem with the monitor. (Some PCs do not output the signal soon after powering on.)</li> <li><input type="checkbox"/> Check that the PC is turned ON.</li> <li><input type="checkbox"/> Check that the signal cable is properly connected to the PC or graphics board.</li> </ul>
<ul style="list-style-type: none"> <li>• Whenever an error signal message appears, the signal frequency will be displayed with blinking. (Example: Digital input)</li> </ul> 	<ul style="list-style-type: none"> <li><input type="checkbox"/> Use the graphics board's utility software to change the frequency setting. (Refer to the manual of the graphics board.)</li> </ul>

Problems	Points to check with possible solutions
<p><b>3. Display position is incorrect.</b></p> 	<p><input type="checkbox"/> Adjust the image position using the &lt;Position&gt; (p.22) If the problem persists, use the graphics board's utility software to change the display position if available.</p>
<p><b>4. Screen image is smaller or larger than the actual screen images.</b></p>	<p><input type="checkbox"/> Adjust the resolution using the &lt;Resolution&gt; (p.22)</p>
<p><b>5. Vertical bars of distortion appear.</b></p> 	<p><input type="checkbox"/> Decrease the vertical bars using the &lt;Clock&gt;. (p.21)</p>
<p><b>6. Horizontal bars of distortion appear.</b></p> 	<p><input type="checkbox"/> Decrease the horizontal bars using the &lt;Phase&gt;. (p.21)</p>
<p><b>7. Letters and lines appear blurred.</b></p>	<p><input type="checkbox"/> Adjust the blurred lines using &lt;Smoothing&gt; (p.24)</p>
<p><b>8. The slightly shadowed images or characters appear.</b></p> <ul style="list-style-type: none"> <li>Bright vertical bars on the right side of the characters and images</li> </ul> 	<p><input type="checkbox"/> Change the mode in the &lt;Signal Filter&gt;.</p> <p><input type="checkbox"/> This problem may appear in case of connecting some analog graphics board.</p>
<p><b>9. Distortion appears like the figure below.</b></p> 	<p><input type="checkbox"/> This happens when both composite (X-OR) input signal and separate vertical synchronizing signal are input. Please select one of the two.</p>

Problems	Points to check with possible solutions
<b>10. The screen is too bright or too dark.</b>	<input type="checkbox"/> Adjust the <Brightness> (The backlight of the LCD monitor has a fixed life span. When the screen becomes dark or begins to flicker, please contact your dealer.) <input type="checkbox"/> Confirm the followings if the screen is too dark. <ul style="list-style-type: none"> <li>• In the case of connecting to the analog graphics board, choose color by the signal select button on the front panel.</li> </ul>
<b>11. Afterimages appear.</b>	<input type="checkbox"/> Do you use the screen saver or timer (p.18) when displaying the same image for extended periods of time? <input type="checkbox"/> Afterimages are particular to LCD monitors. Avoid displaying the same image for extended periods of time.
<b>12. The screen has defective pixels (e.g. slightly light or dark).</b>	<input type="checkbox"/> This is due to the characteristics of the panel itself, and not the LCD product.
<b>13. Fingerprints remain on the screen.</b>	<input type="checkbox"/> Leaving the screen white may solve the problem.
<b>14. &lt;Smoothing&gt; cannot be selected.</b>	<input type="checkbox"/> <Smoothing> is disabled when the screen is displayed in the 1280 x1024. <input type="checkbox"/> The image size is doubled both in horizontally and vertically to (i.e. 1280 x 960 enlarged from 640 x 480) provide clear focus which does not require this function.
<b>15. “Locked!” message appears and the adjustment controls are not available when pressing the control buttons.</b> <div style="text-align: center; margin-top: 10px;">  </div>	<input type="checkbox"/> After the calibration, the functions like brightness are automatically locked. Please refer to page 19 to unlock.
<b>16. The Enter button does not operate.</b>	<input type="checkbox"/> The adjustment lock is probably on. To unlock: switch the LCD monitor off. Then, while pressing the Auto adjustment button, switch the power on. (p.18)

Problems	Points to check with possible solutions
<p><b>17. The Auto adjustment button does not operate.</b></p>	<ul style="list-style-type: none"> <li><input type="checkbox"/> The adjustment lock is probably on. To unlock: switch the LCD monitor off. Then, while pressing the Auto adjustment button, switch the power on. (p.18)</li> <li><input type="checkbox"/> The Auto sizing function is intended for use on the Macintosh and on AT-compatible PC running Windows. It may not work properly in either of the following cases. <ul style="list-style-type: none"> <li>• When running an AT-compatible PC on MS-DOS (Not windows). The background color for the “wall paper” or “desktop” pattern is set to black.</li> <li>• Some signals from a graphics board may not function properly.</li> </ul> </li> </ul>
<p><b>18. USB function cannot be setup.</b></p>	<ul style="list-style-type: none"> <li><input type="checkbox"/> Check that the USB cable is correctly connected.</li> <li><input type="checkbox"/> Check that the PC and OS are USB compliant. (For verification of USB support, consult the manufacturer of each system.)</li> <li><input type="checkbox"/> Check the PC’s BIOS setting for USB. (For details, refer to the manual of the PC.)</li> </ul>
<p><b>19. PC is hung up. /The peripherals connected to the downstream ports do not operate.</b></p>	<ul style="list-style-type: none"> <li><input type="checkbox"/> Check that the USB cable is correctly connected.</li> <li><input type="checkbox"/> Check the downstream ports by connecting the peripherals to other downstream ports. If the problem is solved by doing this, contact an EIZO dealer. (For details, refer to the manual of the PC.)</li> <li><input type="checkbox"/> Try executing the following method. <ul style="list-style-type: none"> <li>• Restarting the PC</li> <li>• Connecting the PC and peripherals directly</li> </ul> <p>If the problem is solved by doing this, contact an EIZO dealer.</p> </li> <li><input type="checkbox"/> The power button of the APPLE keyboard does not operate if it is connected to the EIZO USB Hub. Please connect the keyboard directly with the PC. Refer to the instruction of the PC for details.</li> </ul>

---

## 8. CLEANING

Periodic cleaning is recommended to keep the monitor looking new and to prolong its operation lifetime.

### **NOTE**

- Never use thinner, benzene, alcohol (ethanol, methanol, or isopropyl alcohol), abrasive cleaners, or other strong solvents, as these may cause damage to the cabinet or LCD panel.

### **Cabinet**

To remove stains, wipe the cabinet with a soft, lightly moistened cloth using a mild detergent. Do not spray wax or cleaner directly into the cabinet. (For details, refer to the manual of the PC.)

### **LCD Panel**

- The LCD surface can be cleaned with a soft cloth, such as cotton or lens paper.
- If necessary, stubborn stains can be removed by moistening part of a cloth with water to enhance its cleaning power.

# 9. SPECIFICATIONS

LCD Panel	46 cm (18.1 inch), TFT Monochrome LCD panel Anti-Glare Hard coating 2H
Viewing Angle	Horizontal: 170°, Vertical: 170° (CR≥10)
Dot Pitch	0.2805 mm
Horizontal Scan Frequency	Analog: 27 ~ 82 kHz (Automatic), Digital: 27 ~ 64 kHz
Vertical Scan Frequency	Analog: 50 Hz ~ 85 Hz (Automatic) (1280 x 1024: 50 Hz ~ 75 Hz) Digital: 60Hz, (VGA TEXT : 70Hz)
Resolution	1M pixels (1280 dots x 1024 lines)
Dot Clock (Max.)	Analog: 135 MHz, Digital: 108 MHz
Gray Scale	256 steps of 1531 steps
Display Area	359 mm (H) x 287 mm (V) (14.1" (H) x 11.3" (V)) (Viewable image size: 459 mm (18.1"))
Power Supply	100-120/200-240 VAC ± 10%, 50/60 Hz, 0.6-0.5/0.3-0.25 A
Power Consumption	Min.: 50 W, Max.: 60 W (With USB hub) Power Saving Mode: Less than 8 W (When the USB hub are not connected.)
Input Connector	DVI-I x 1
Analog Input Signal (Sync)	a) Separate, TTL, Positive/Negative
	b) Composite, TTL, Positive/Negative
	c) Sync on Green, 0.3 Vp-p, Negative
Analog Input Signal (Video)	0.7Vp-p/75Ω Positive
Digital Input Signal	TMDS (Single Link)
Analog Signal registration	45 (Factory preset: 25)
Plug & Play	VESA DDC 2B
Dimensions	399 mm (W) x 404~ 504 mm (H) x 203 mm (D) (15.7"(W) x 15.9" ~ 19.8" (H) x 8.0"(D))
Dimensions (without stand)	399mm (W) x 328mm (H) x 65mm (D) (15.7"(W) x 12.9"(H) x 2.6"(D))
Weight	7.8 kg (17.2 lbs.)
Weight (without stand)	5.5 kg (12.1 lbs.)
Environment conditions	
Temperature	Operating: 0 °C ~ 35 °C (32 °F ~ 95 °F) Storage: -20 °C ~ 60 °C (-4 °F ~ 140 °F)
Humidity	30% to 80% R.H. Non-condensing
Pressure	860 to 1,060 hPa
USB standard	Rev. 1.1 complied self-powered hub
Communication speed	12 Mbps (full), 1.5 Mbps (low)
Downstream power supply	500 mA for each (Max.)
USB ports	Upstream port x 1, Downstream port x 2

Certifications and Standards	TÜV Rheinland /GM, CB, NRTL/C-TÜV, CE (93/42/EEC), FCC-A,
Classification of equipment	Type of protection against electric shock: Class I EMC class: EN60601-1-2 Class A Classification of medical device: Class I

## Dimensions

mm (inches)

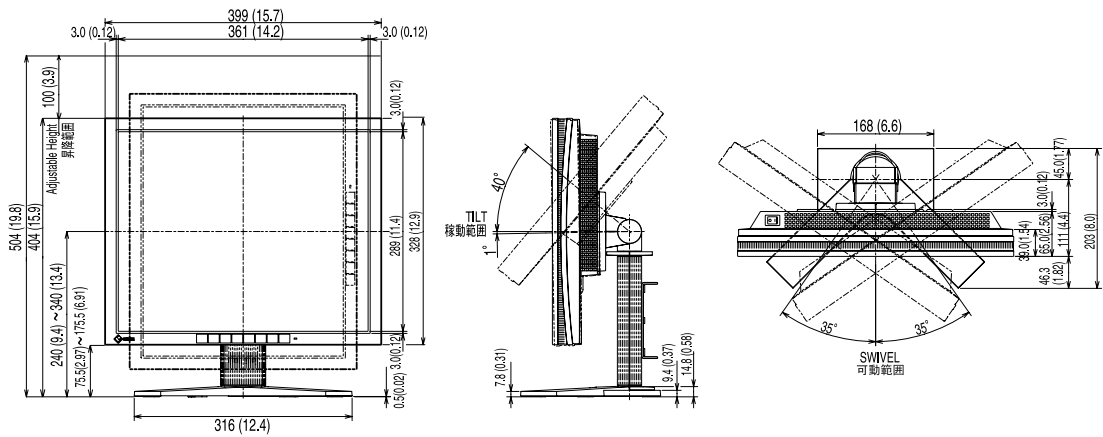

## Default settings

	Analog input	Digital input
Signal Selection	Color	-
Smoothing	3	
PowerManager	VESA DPMS	DVI DMPM
Screen Size	Normal	
Off Timer	Disable	
Menu Settings	Menu Size: Normal, Menu Off Timer: 45 seconds	
Orientation	Landscape	
Language	English	

## Optional

Calibration Kit	EIZO RadiCS GX2
Signal Adapter (DVI-I/BNC)	EIZO RadiForce BNC Adaptor BI00FM

## Pin Assignment

### DVI-I Connector

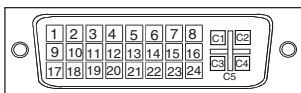

Pin No.	Signal	Pin No.	Signal	Pin No.	Signal
1	TMDS Data2-	11	TMDS Data1/3 Shield	21	NC*
2	TMDS Data2+	12	NC*	22	TMDS Clock shield
3	TMDS Data2/4 Shield	13	NC*	23	TMDS Clock+
4	NC*	14	+5V Power	24	TMDS Clock-
5	NC*	15	Ground (return for +5V, Hsync and Vsync)	C1	Analog Red
6	DDC Clock (SCL)	16	Hot Plug Detect	C2	Analog Green
7	DDC Data (SDA)	17	TMDS Data0-	C3	Analog Blue
8	Analog Vertical Sync	18	TMDS Data0+	C4	Analog Horizontal Sync
9	TMDS Data1-	19	TMDS Data0/5 Shield	C5	Analog Ground (analog R, G, & B return)
10	TMDS Data1+	20	NC*		

(\*NC: No Connection)

### Remote In connector (Mini DIN 6 pin)



Pin No.	Signal
1	NC*
2	NC*
3	TXD
4	RXD
5	NC*
6	GND

(\*NC: No Connection)

### Photo sensor connector (Mini DIN 8 pin)



Pin No.	Signal
1	NC*
2	RXD
3	TXD
4	NC*
5	GND
6	NC*
7	NC*
8	NC*

(\*NC: No Connection)



## USB Ports

Upstream

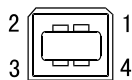

Series B

Downstream



Series A

No.	Signal	Signal
1	VCC	Cable power
2	- Data	Serial data
3	+ Data	Serial data
4	Ground	Cable Ground

## Preset Timing Chart for Analog input

Based on the signal diagram shown below 25 factory presets have been registered in the monitor's microprocessor.

Mode	Dot Clock MHz	Frequencies		Sync Polarity	
		H kHz	V Hz	H	V
VGA 640 × 480	25.175	31.469	59.940	Nega.	Nega.
VGA 720 × 400	28.322	31.468	70.087	Nega.	Posi.
Macintosh 640 × 480	30.24	35.00	66.67	Nega.	Nega.
Macintosh 832 × 624	57.28	49.73	74.55	Posi.	Posi.
Macintosh 1152 × 870	100.0	68.68	75.06	Nega.	Nega.
Macintosh 1280 × 960	126.2	74.76	74.76	Posi.	Posi.
VESA 640 × 480	31.5	37.86	72.81	Nega.	Nega.
VESA 640 × 480	31.5	37.50	75.00	Nega.	Nega.
VESA 640 × 480	36.0	43.27	85.01	Nega.	Nega.
VESA 800 × 600	36.0	35.16	56.25	Posi.	Posi.
VESA 800 × 600	40.0	37.88	60.32	Posi.	Posi.
VESA 800 × 600	50.0	48.08	72.19	Posi.	Posi.
VESA 800 × 600	49.5	46.88	75.00	Posi.	Posi.
VESA 800 × 600	56.25	53.674	85.061	Posi.	Posi.
VESA 1024 × 768	65.0	48.36	60.00	Nega.	Nega.
VESA 1024 × 768	75.0	56.48	70.07	Nega.	Nega.
VESA 1024 × 768	78.75	60.02	75.03	Posi.	Posi.
VESA 1024 × 768	94.5	68.68	85.0	Posi.	Posi.
VESA 1152 × 864	75.0	67.50	75.00	Posi.	Posi.
VESA 1280 × 960	60.0	60.00	60.00	Posi.	Posi.
VESA 1280 × 1024	108.0	63.98	60.02	Posi.	Posi.
VESA 1280 × 1024	135.0	79.98	75.03	Posi.	Posi.
Workstation 1152 × 900	94.2	61.974	66.141	Composite, Nega.	
Workstation 1152 × 900	107.50	71.858	76.202	Composite, Nega.	
Workstation 1280 × 1024	117.0	71.691	67.189	Composite, Nega.	

# 10. GLOSSARY

## **Clock**

With the analog input signal display, the analog signal is converted to a digital signal by the LCD circuitry. To convert the signal correctly, the LCD monitor needs to produce the same number clock pulse as the dot clock of the graphics system. When the clock pulse is not correctly set, some vertical bars of distortion are displayed on the screen.

## **DVI**

(Digital Visual Interface)

A digital flat panel interface. DVI can transmit digital data from the PC directly without loss with the signal transition method "TMDS".

There are two kinds of DVI connectors. One is DVI-D connector for digital signal input only. The other is DVI-I connector for both digital and analog signal inputs.

## **DVI DMPM**

(DVI Digital Monitor Power Management)

The Power management system for the digital interface. The "Monitor ON" status (operation mode) and the "Active Off" status (power-saving mode) are indispensable for the DVI-DMPM as the monitor's power mode.

## **LUT**

(Look-up table)

Look-up table is the compensation data, to which the monitor refers, when the monitor outputs the input data from a graphics board. In this model, the "Default\*" adjusted beforehand referring to look-up table at a factory or "Normal", which is in the state of the characteristic of panel original, (i.e. not adjusted) can be available. "Custom" automatically stores the customized data after the calibration is performed. \* "Default" is adjusted with the factory default brightness to DICOM grayscale standard.

## **Phase**

The phase adjustment decides the sampling timing point for converting the analog input signal to a digital signal. Adjusting the phase after the clock adjustment will produce a clear screen.

## **Range Adjustment**

The Range Adjustment controls the level of output signal range to display the whole gradation (256 steps).

**Resolution**

The LCD panel consists of a fixed number of pixel elements which are illuminated to form the screen image. The EIZO G11-S display panel consists of 1280 horizontal pixels and 1024 vertical pixels. At a resolution of 1280 x 1024, all pixels are displayed as a full screen.

**TMDS**

(Transition Minimized Differential Signaling)

A signal transition method for the digital interface

**VESA DPMS**

(Video Electronics Standard Association – Display Power Management Signaling)

The acronym VESA stands for “Video Electronics Standards Association”, and DPMS stands for “Display Power Management Signaling.” DPMS is a communication standard that PCs and graphics boards use to implement power savings on the monitor side.

# MEMO



## **EIZO NANA O CORPORATION**

153 Shimokashiwano, Hakusan, Ishikawa 924-8566 Japan  
Phone: +81 76 277 6792 Fax: +81 76 277 6793

## **EIZO GmbH**

Siemensallee 84, 76187 Karlsruhe, Germany  
Phone: +49 721 595 2614 Fax: +49 721 595 4558

## **株式会社ナナオ**

〒924-8566 石川県白山市下柏野町 153 番地

<http://www.radiforce.com>



This document is printed on recycled chlorine free paper.

4th Edition-November, 2008 Printed in Japan.

00N0L011D1  
(UM-G11-S)