



Installation Manual

RadiForce® MX217 Color LCD Monitor

Important

To ensure that the product is used correctly, carefully read through this Installation Manual and the Instructions for Use before use.

- See the Instructions for Use for monitor installation and connection.
- You can check the latest product information, including the Installation Manual, from our web site.
www.eizoglobal.com

This product has been adjusted specifically for use in the region to which it was originally shipped.
If operated outside this region, the product may not perform as stated in the specifications.

No part of this manual may be reproduced, stored in a retrieval system, or transmitted, in any form or by any means, electronic, mechanical, or otherwise, without the prior written permission of EIZO Corporation.

EIZO Corporation is under no obligation to hold any submitted material or information confidential unless prior arrangements are made pursuant to EIZO Corporation's receipt of said information. Although every effort has been made to ensure that this manual provides up-to-date information, please note that EIZO product specifications are subject to change without notice.

CONTENTS

1 Basic Operation and Function List	5
1.1 Usage of Switches and Operation Guide	5
1.2 Basic Operation of the Setting Menu	6
1.3 Function List.....	7
2 Adjusting the Screen	9
2.1 Compatible Resolutions	9
2.2 Setting the Input Signal	9
2.3 Selecting Display Mode (CAL Switch Mode).....	9
2.4 Adjusting Brightness / Colors	10
2.4.1 Adjustment items for each mode	10
2.4.2 Enabling or disabling Hybrid Gamma PXL.....	11
2.4.3 Adjusting the brightness.....	11
2.4.4 Adjusting the contrast	11
2.4.5 Adjusting the color temperature	12
2.4.6 Adjusting the gamma	12
2.4.7 Adjusting the hue	12
2.4.8 Adjusting the color saturation.....	12
2.4.9 Adjusting the gain	13
2.5 Enabling or Disabling Sharpness Recovery (the Function of Correcting Image Clarity).....	13
3 Controlling Monitor Quality	14
3.1 Using the SelfCalibration Function	14
3.1.1 Executing SelfCalibration.....	14
3.1.2 Checking the SelfCalibration results	15
3.2 Using the Grayscale Check Function.....	15
3.2.1 Performing Grayscale Check.....	15
3.2.2 Checking the Grayscale Check results	16
3.3 Setting Whether to Display / Hide Warnings or QC History	16
4 Using the Monitor for a Long Time	17
4.1 Setting the Power Saving Mode.....	17
5 Configuring Monitor Settings	18
5.1 Specifying the Language.....	18
5.2 Automatically Detecting the Input Signal.....	18
5.3 Switching Screen Sizes.....	18
5.4 Setting the Version for DisplayPort Input	18
5.5 Setting the Image Display Orientation.....	19
5.6 Adjusting Brightness of the Power Switch Indicator	19
5.7 Skipping Unused Display Modes	19

CONTENTS





5.8	Enabling or Disabling DisplayPort Communication in Power Saving Mode.....	20
5.9	Locking Operation Switches.....	20
5.10	Setting Whether to Display / Hide the Grayscale Warning.....	20
5.11	Acquiring Life Estimation Data.....	21
5.12	Viewing the Monitor Information.....	21
5.13	Resetting to Defaults.....	22
5.13.1	Resetting the color adjustment value.....	22
5.13.2	Resetting all settings.....	22
6	Troubleshooting.....	23
6.1	No Picture.....	23
6.2	Imaging Problems.....	24
6.3	Other Problems.....	24
6.4	Error Code Table.....	26
7	Reference.....	27
7.1	Attaching an Optional Arm.....	27
7.2	Using the USB Hub Function.....	28
7.3	Main Default Settings.....	29
7.3.1	CAL Switch Mode.....	29
7.3.2	Others.....	29
	Appendix.....	30
	Trademark.....	30
	License.....	30
	LIMITED WARRANTY.....	30

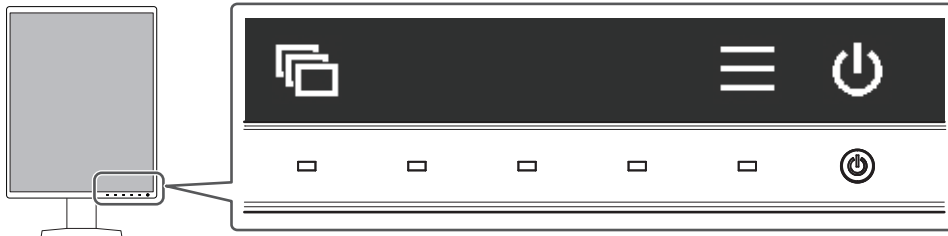

1 Basic Operation and Function List

1.1 Usage of Switches and Operation Guide

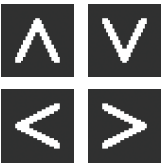
1. Touch any switch (except )
The operation guide appears on the screen.



Display	Function
	Turns the power on or off.
	Displays the Setting menu. The Setting menu is used to configure advanced monitor settings.
	Switches display modes. For more information about how to switch display modes, see 2.3 Selecting Display Mode (CAL Switch Mode) [▶ 9] .
	Selects an item.
	Applies the selected content.
	Cancels the selection.

2. Touch a switch for the icon showing the item you want to set.
The menu appears.
3. Use each switch to configure the setting. If necessary, select  to apply the setting.
4. Select  to exit the menu.

Note



- The menu and operation guide will automatically disappear after a few seconds if no switches are operated.

1.2 Basic Operation of the Setting Menu

1. Select  from the operation guide.
The Setting menu appears.



Note

- To adjust or set "Administrator Settings" items, display the Setting menu according to the following procedure:
 1. Select  to turn off the monitor.
 2. While touching the leftmost switch () , touch  for more than two seconds to turn on the monitor. "Administrator Settings" appears.

2. Select a menu to adjust / set using   , then select  .

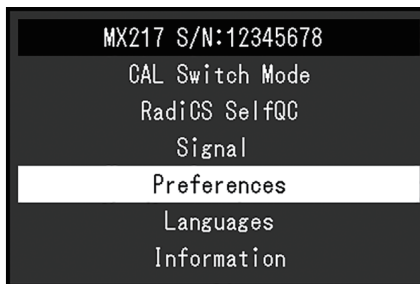

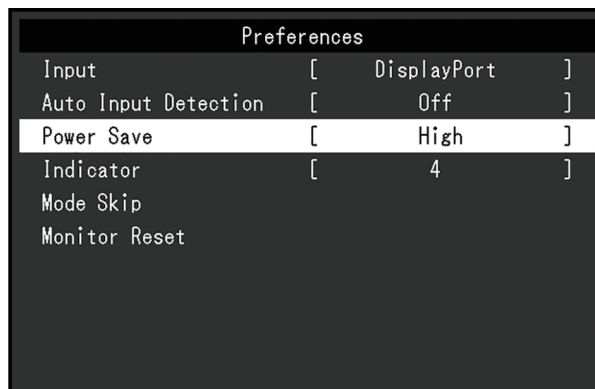

The advanced menu appears.

3. Select an item to adjust / set using   , then select  .



The Adjustment / Setting menu appears.

4. Adjust / set the selected item using   , and then select  .

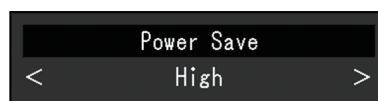

Note

- The settings for "Administrator Settings" items are applied by selecting "Apply".

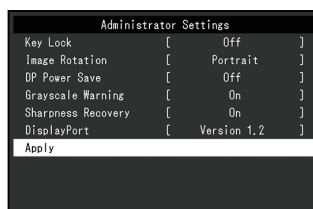

5. Select  several times to exit the Setting menu.

Note

- The menu for "Administrator Settings" items is exited by selecting "Apply".

1.3 Function List

The following table shows the items in the Setting menu.

Main menu	Item	Reference
CAL Switch Mode	Mode	2.4 Adjusting Brightness / Colors [▶ 10] Note <ul style="list-style-type: none"> • The functions that can be adjusted or set in "CAL Switch Mode" differ depending on the mode (see Adjustment items for each mode [▶ 10]).
	Hybrid Gamma PXL	
	Brightness	
	Contrast	
	Temperature	
	Gamma	
	Hue	
	Saturation	
	Gain	
	Reset	
RadiCS SelfQC	SelfCalibration	3.1 Using the SelfCalibration Function [▶ 14]
	Grayscale Check	3.2 Using the Grayscale Check Function [▶ 15]
	LEA	5.11 Acquiring Life Estimation Data [▶ 21]
	Settings	3.3 Setting Whether to Display / Hide Warnings or QC History [▶ 16]
Signal	Screen Size	5.3 Switching Screen Sizes [▶ 18]
Preferences	Input	2.2 Setting the Input Signal [▶ 9]
	Auto Input Detection	5.2 Automatically Detecting the Input Signal [▶ 18]
	Power Save	4.1 Setting the Power Saving Mode [▶ 17]
	Indicator	5.6 Adjusting Brightness of the Power Switch Indicator [▶ 19]
	Mode Skip	5.7 Skipping Unused Display Modes [▶ 19]
	All Reset	5.13 Resetting to Defaults [▶ 22]
Languages		5.1 Specifying the Language [▶ 18]
Information		5.12 Viewing the Monitor Information [▶ 21]
Administrator Settings	Key Lock	5.9 Locking Operation Switches [▶ 20]
	Image Rotation	5.5 Setting the Image Display Orientation [▶ 19]
	DP Power Save	5.8 Enabling or Disabling DisplayPort Communication in Power Saving Mode [▶ 20]

Main menu	Item	Reference
	Grayscale Warning	5.10 Setting Whether to Display / Hide the Grayscale Warning [▶ 20]
	Sharpness Recovery	2.5 Enabling or Disabling Sharpness Recovery (the Function of Correcting Image Clarity) [▶ 13]
	DisplayPort	5.4 Setting the Version for DisplayPort Input [▶ 18]

2 Adjusting the Screen

2.1 Compatible Resolutions

For information about the compatible resolutions of the monitor, see "Compatible Resolutions" in the Instructions for Use.

2.2 Setting the Input Signal

You can select the input signal to be displayed on the screen.

1. Select "Preferences" from the Setting menu, then select .
 2. Select "Input" and then .
 3. Use either or to select "DisplayPort" or "DVI", then select .
- When the setting is complete, the input port names appear.

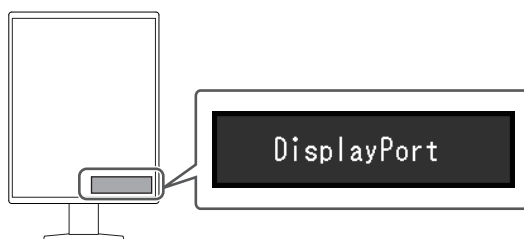

Attention

- If you turn the main power off and on again, the input signal is automatically detected regardless of the setting.
- If the PC that outputs the specified signal enters the power saving mode or is turned off when "Auto Input Detection" is set to "On", any other available signal is displayed automatically. For more information, see [5.2 Automatically Detecting the Input Signal \[▶ 18\]](#).

2.3 Selecting Display Mode (CAL Switch Mode)

The display mode can be selected according to the monitor application.

✓: Can be calibrated



Mode	Purpose	
1-DICOM	Enables display using DICOM® Part 14-compliant grayscale characteristics.	✓
2-CAL1	Displays the calibration status using calibration software.	✓
3-CAL2		✓
4-Custom	Select this mode to configure desired settings.	-
5-sRGB	Suitable for color matching with sRGB compatible peripherals.	-
6-Text	Suitable to display documents, spreadsheets, or other text.	-

1. Touch any switch (except)

2. Select  from the operation guide.
The Mode menu appears on the lower right.

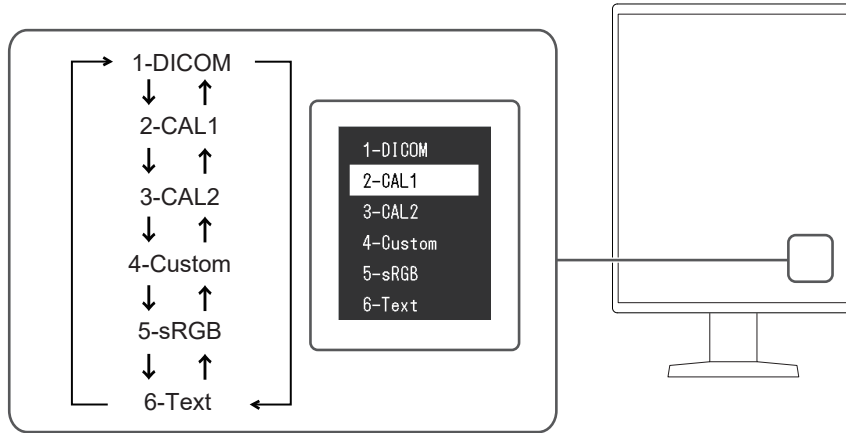
Example:



3. Modes are changed in sequence each time you select .
You can also select  or  to change modes when the Mode menu is being displayed.

Note

- The Setting menu and Mode menu cannot be displayed at the same time.

2.4 Adjusting Brightness / Colors

You can adjust brightness and colors for each mode, and save the settings.

Attention

- It takes about 15 minutes for the electrical parts in the product to become stable. Please wait 15 minutes or more after the monitor power has been turned on or the monitor has recovered from the power saving mode before performing adjustment.
- The same image may be observed in different colors on multiple monitors due to monitor-specific characteristics. Make fine color adjustment visually when matching colors on multiple monitors.

Note

- Use the values shown in "Brightness" and "Temperature" as a guide only.

2.4.1 Adjustment items for each mode

Adjustable functions differ depending on the mode type. (Functions that cannot be adjusted or set are not selectable.)

✓: Adjustable -: Not adjustable

Function	CAL Switch Mode					
	1-DICOM	2-CAL1	3-CAL2	4-Custom	5-sRGB	6-Text
Hybrid Gamma PXL	✓	✓	✓	-	-	-
Brightness	-	-	-	✓	✓	✓
Contrast	-	-	-	✓	✓	✓
Temperature	-	-	-	✓	✓	✓

Function	CAL Switch Mode					
	1-DICOM	2-CAL1	3-CAL2	4-Custom	5-sRGB	6-Text
Gamma	-	-	-	✓	✓	✓
Hue	-	-	-	✓	✓	✓
Saturation	-	-	-	✓	✓	✓
Gain	-	-	-	✓	✓	✓
Reset	✓	✓	✓	✓	✓	✓

2.4.2 Enabling or disabling Hybrid Gamma PXL

When the Hybrid Gamma PXL function is enabled, this product automatically differentiates between monochrome and color parts of the same image at a pixel level, and displays a color image using the gamma value for color image display.

Settings: "On" / "Off"

1. Select "CAL Switch Mode" from the Setting menu, then select .
2. Select "Hybrid Gamma PXL" and then .
3. Select "On" or "Off", then select .

2.4.3 Adjusting the brightness

The screen brightness is adjusted by changing the brightness of the backlight (light source from the LCD back panel).

Settings: "0%" – "100%"

1. Select "CAL Switch Mode" from the Setting menu, then select .
2. Select "Brightness" and then .
3. Specify the setting using or .
4. Select after completing the setting.

Note

- If the image is too bright even when the brightness is set to 0 %, adjust the contrast.

2.4.4 Adjusting the contrast

The brightness of the screen is adjusted by varying the video signal level.

Settings: "0%" – "100%"

1. Select "CAL Switch Mode" from the Setting menu, then select .
2. Select "Contrast" and then .
3. Specify the setting using or .
4. Select after completing the setting.

Note

- When the contrast is set to 100 %, all the color gradations are shown.
- When adjusting the monitor, it is recommended to perform brightness adjustment, which does not lose gradation characteristics, prior to contrast adjustment.
- Perform contrast adjustment in the following cases.
 - If the screen is too bright even when the brightness is set to 0 %

2.4.5 Adjusting the color temperature

Adjusts the color temperature.

The color temperature is normally used to express the hue of "White" and/or "Black" with a numerical value. The value is expressed in degrees "K" (Kelvin).

The screen becomes reddish at low color temperatures and bluish at high color temperatures, similar to the temperatures of a flame. A gain preset value is set for each color temperature setting value.

Settings: "Native" / "6000 K" to "15000 K"(in increments of 100 K) / "sRGB"

1. Select "CAL Switch Mode" from the Setting menu, then select .
2. Select "Temperature" and then .
3. Specify the setting using or .
4. Select after completing the setting.

Note

- "Gain" allows you to perform more advanced adjustment (see [Adjusting the gain \[▶ 13\]](#)).
- If set to "Native", the image is displayed in the preset color of the monitor (Gain: 100 % for each RGB channel).
- When the gain is changed, the color temperature setting changes to "User".

2.4.6 Adjusting the gamma

Adjusts the gamma value. While the brightness of the monitor varies depending on the video level of the input signal, the variation rate is not directly proportional to the input signal. Maintaining the balance between the input signal and brightness of the monitor is referred to as "Gamma correction".

Settings: "1.6" – "2.7" / "sRGB"

1. Select "CAL Switch Mode" from the Setting menu, then select .
2. Select "Gamma" and then .
3. Specify the setting using or .
4. Select after completing the setting.

2.4.7 Adjusting the hue

Adjust the hue.

Settings: "-100" to "100"

1. Select "CAL Switch Mode" from the Setting menu, then select .
2. Select "Hue" and then .
3. Specify the setting using or .
4. Select after completing the setting.

Attention



- Using this function may prevent some color gradations from being able to be displayed.

2.4.8 Adjusting the color saturation

Adjust the color saturation.

Settings: "-100" to "100"

1. Select "CAL Switch Mode" from the Setting menu, then select .
2. Select "Saturation" and then .

3. Specify the setting using  or .
4. Select  after completing the setting.

Attention

- Using this function may prevent some color gradations from being able to be displayed.







Note

- The minimum value (-100) changes the screen to monochrome.

2.4.9 Adjusting the gain

The brightness of each red, green, and blue color component is referred to as "Gain". The hue of "White" can be changed by adjusting the gain.

Settings: "0%" – "100%"

1. Select "CAL Switch Mode" from the Setting menu, then select .
2. Select "Gain" and then .
3. Select the color to be adjusted from "Red", "Green", and "Blue", then select .
4. Specify the setting using  or .
5. Select  after completing the setting.

Attention









- Using this function may prevent some color gradations from being able to be displayed.

Note

- The gain value changes according to the color temperature.
- When the gain is changed, the color temperature setting changes to "User".

2.5 Enabling or Disabling Sharpness Recovery (the Function of Correcting Image Clarity)

EIZO's unique technology called "Sharpness Recovery" improves picture clarity and displays images that are true to the original source data.

1. Select  to turn off the monitor.
2. While touching the leftmost switch () , touch  for more than two seconds to turn on the monitor.
3. Select "Sharpness Recovery" in "Administrator Settings", then select .
4. Use  or  to select either "On" or "Off" and then select .
5. Select "Apply" and then .

Attention

- After changing the setting, perform a visual check according to the medical standards / guidelines.

3 Controlling Monitor Quality

The monitor includes the Integrated Front Sensor, which enables you to perform calibration and Grayscale Check independently.

Note

- Calibration can be performed periodically by using the schedule function of RadiCS LE that is attached to the monitor. For more information about the setup procedure, refer to the RadiCS LE User's Manual (stored on the CD-ROM).
- RadiCS enables you to configure the schedule settings for Grayscale Check as well as for calibration. For more information about the setup procedure, refer to the RadiCS User's Manual.
- If you want to perform high-level quality control in compliance with medical standards / guidelines, use optional monitor quality control software kit "RadiCS UX2".
- To adjust measurement results of the Integrated Front Sensor to those of an EIZO external sensor (UX2 Sensor), perform correlation between the Integrated Front Sensor and the external sensor by using RadiCS / RadiCS LE. Periodical correlation allows you to maintain the measurement accuracy of the Integrated Front Sensor at a level equivalent to that of the external sensor. For details, refer to the RadiCS / RadiCS LE User's Manual. The accuracy of the Integrated Front Sensor of this product is optimized for the portrait display in its factory setting. When performing quality control using the Integrated Front Sensor in a landscape display, be sure to perform correlation in the landscape display. For details on correlation, refer to the RadiCS / RadiCS LE User's Manual.

3.1 Using the SelfCalibration Function

Execute SelfCalibration and view the latest results.

3.1.1 Executing SelfCalibration

1. Select "RadiCS SelfQC" from the Setting menu, then select .
2. Select "SelfCalibration" in "RadiCS SelfQC", then select .
3. Select "Execute" and then .
SelfCalibration is executed.

Attention

- If the power to the PC is turned off or the input signal switches while SelfCalibration is running, the execution will be canceled.
- After SelfCalibration is complete, perform Grayscale Check at the same room temperature and illuminance as those in the actual working environment.

Note

- The following items can be set by using RadiCS / RadiCS LE. For more information about the setup procedure, refer to RadiCS / RadiCS LE User's Manual.
 - Calibration target
 - SelfCalibration schedule
 - The next execution schedule is displayed in the advanced menu if the schedule was set in RadiCS / RadiCS LE.

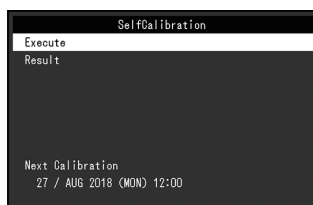

- The calibration target value can be confirmed by selecting the target mode in "CAL Switch Mode" of the Setting menu.

3.1.2 Checking the SelfCalibration results**Attention**

- The results can be checked when "QC History" is set to "On" (see [3.3 Setting Whether to Display / Hide Warnings or QC History](#) [▶ 16]).

1. Select "RadiCS SelfQC" from the Setting menu, then select .
2. Select "SelfCalibration" and then .
3. Select "Result" and then .
4. Use or to select either "DICOM", "CAL1", or "CAL2" and then select . The SelfCalibration results (such as Max. Error Rate, Last Time, and Error Code) are displayed.

3.2 Using the Grayscale Check Function

Perform Grayscale Check and view the latest results. Furthermore, if you have configured the schedule using RadiCS, the next execution schedule is displayed.

3.2.1 Performing Grayscale Check**Attention**

- Perform the Grayscale Check based on the actual color temperature and brightness of the working environment.

1. Select "RadiCS SelfQC" from the Setting menu, then select .
2. Select "Grayscale Check" and then .
3. Select "Execute" and then . Grayscale Check is executed.

Attention

- The determination value for Grayscale Check can be specified from RadiCS. Refer to the RadiCS User's Manual for details.
- The Grayscale Check schedule can be configured using RadiCS. For more information about the setup procedure, refer to the RadiCS User's Manual. If you have configured the schedule using RadiCS, the next execution schedule is displayed in the advanced menu.

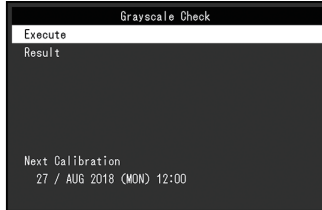

3.2.2 Checking the Grayscale Check results

Attention

- The results can be checked when "QC History" is set to "On".

1. Select "RadiCS SelfQC" from the Setting menu, then select .
2. Select "Grayscale Check" and then .
3. Select "Result" and then .
4. Use or to select either "DICOM", "CAL1", or "CAL2" and then select .
Up to five past Grayscale Check results (Passed, Failed, Canceled, or Error) are displayed.

3.3 Setting Whether to Display / Hide Warnings or QC History

You can set whether to display or hide warnings related to "Failed" Grayscale Check results, or the execution results (QC History) of SelfCalibration, Grayscale Check, etc.





1. Select "RadiCS SelfQC" from the Setting menu, then select .
2. Select "Settings" and then .
3. Use or to select either "Warning" or "QC History".
4. Use or to select either "On" or "Off" and then select .

4 Using the Monitor for a Long Time

The monitor can be set to enter the power saving mode according to the PC status. The life of the monitor backlight can be extended by setting the monitor to enter the power saving mode when the monitor is not used.

4.1 Setting the Power Saving Mode

You can specify whether the monitor enters the power saving mode according to the PC status.

1. Select "Preferences" from the Setting menu, then select .
2. Select "Power Save" and then .
3. Use  or  to select "High", "Low", or "Off", then select .

Setting	Function
High	Turns the backlight off. This provides the highest power saving effect.
Low	Sets the backlight to the lowest lighting level. The time until operation stabilizes after restoring from power saving mode can be reduced.
Off	Does not enable the power saving mode. The backlight lights up irrespective of the PC status. This setting may shorten the backlight life.

Attention

- When not using the monitor, you can turn off the main power supply or disconnect the power plug so that the power is cut completely.
- Devices connected to the USB upstream port and downstream port still work when the monitor is in the power saving mode or when the power is switched off using the power button () of the monitor. For this reason, power consumption of the monitor varies with connected devices even in the power saving mode.

Note

- When the signal input from the PC is no longer detected, a message appears notifying the user of the transition to power saving mode. The monitor enters power saving mode five seconds after the message appears.
- When power save is set to "High" or "Low", the status of the monitor can be confirmed by checking the color of the lamp on the power switch.
 - Power indicator is green: Monitor is in normal operation mode
 - Power indicator is orange: Monitor is in power saving mode

5 Configuring Monitor Settings

5.1 Specifying the Language

The language for the Setting menu and messages can be selected.

- Selectable Languages
"English", "Germany", "French", "Spanish", "Italian", "Swedish", "Japanese", "Chinese (simplified)", "Chinese (traditional)"
1. Select "Languages" from the Setting menu, then select .
 2. Select a language, then .

5.2 Automatically Detecting the Input Signal

Automatically detects the connector through which a signal is input, and displays the signal on the screen.

1. Select "Preferences" from the Setting menu, then select .
2. Select "Auto Input Detection" in "Preferences", then select .
3. Use or to select either "On" or "Off" and then select .

Setting	Function
On	Automatically detects the connector through which a signal is input, and displays the signal on the screen. If the PC that is outputting the signal displayed on the screen enters the power saving mode or is turned off when multiple PCs are connected, any other available signal is displayed automatically.
Off	When selecting the input signal manually, select this setting. When you want to switch the input signal, see 2.2 Setting the Input Signal [▶ 9] .

Note

- If you turn the main power off and on again, the input signal is automatically detected regardless of the setting.

5.3 Switching Screen Sizes

In addition to the recommended resolution, you can also set the size of the image display.

1. Select "Signal" from the Setting menu, then select .
2. Select "Picture Expansion" and then .
3. Use or to select "Full Screen", "Aspect Ratio", or "Dot by Dot", then select .

Setting	Function
Full Screen	Images are displayed in full screen. However, as aspect ratios are not maintained, images may be distorted in some cases.
Aspect Ratio	Images are displayed in full screen. As aspect ratios are maintained, blank horizontal or vertical borders may appear.
Dot by Dot	Displays the image at the set resolution or size specified by the input signal.

5.4 Setting the Version for DisplayPort Input

You can set the DisplayPort version.







Attention

- To use a daisy-chain connection, set the version to "Version 1.2".
- When a PC is connected via the DisplayPort connector, the DisplayPort version may differ depending on the PC, and consequently the screen may not appear. In this case, try changing the following settings.

1. Select  to turn off the monitor.
2. While touching the leftmost switch () , touch  for more than two seconds to turn on the monitor.
3. Select "DisplayPort" in "Administrator Settings", then select .
4. Use  or  to select "Version 1.1 10bit", "Version 1.1 8bit", or "Version 1.2", then select .
5. Select "Apply" and then .

5.5 Setting the Image Display Orientation

This function allows you to change the image display orientation according to the monitor installation orientation.

1. Select  to turn off the monitor.
2. While touching the leftmost switch () , touch  for more than two seconds to turn on the monitor.
3. Select "Image Rotation" in "Administrator Settings", then select .
4. Use  or  to select either "Portrait" or "Landscape" and then select .





Setting	Monitor orientation
Portrait	Select this when the monitor is installed in portrait orientation.
Landscape	Select this when the monitor is installed in landscape orientation.

5. Select "Apply" and then .

5.6 Adjusting Brightness of the Power Switch Indicator

The brightness of the power switch indicator (green) while the screen is displayed can be adjusted. The larger the set value, the brighter the power indicator lights up. On the other hand, the smaller the value, the darker it becomes. The "Off" setting turns off the power switch indicator.



Settings: "1" to "7" / "Off"

1. Select "Preferences" from the Setting menu, then select .
2. Select "Indicator" and then .
3. Specify the setting using  or .
4. Select  after completing the setting.

5.7 Skipping Unused Display Modes

This function allows you to skip certain display modes when selecting a mode.

Please use this function if you want to limit the modes to be displayed, or avoid changing the display status randomly.

1. Select "Preferences" from the Setting menu, then select .
2. Select "Mode Skip" and then .

3. Select a mode whose setting you want to change, then select .
4. Use or to select either "Skip" or "-" and then select .

Attention

- Not all modes can be disabled (skipped). Set at least one mode to "-".

5.8 Enabling or Disabling DisplayPort Communication in Power Saving Mode

Connecting a PC to the DisplayPort connector enables DisplayPort communication, and thus consumes high power even in the power saving mode. The communication can be disabled by setting "DP Power Save" to "On". This reduces power consumption in the power saving mode.

Attention

- If "On" is selected, window and icon positions may shift when the monitor is powered back on or returned from the power saving mode. In such cases, set this function to "Off".

1. Select to turn off the monitor.
2. While touching the leftmost switch () , touch for more than two seconds to turn on the monitor.
3. Select "DP Power Save" in "Administrator Settings", then select .
4. Use or to select either "On" or "Off" and then select .
5. Select "Apply" and then .

5.9 Locking Operation Switches

Adjusted or set states can be made unchangeable.

1. Select to turn off the monitor.
2. While touching the leftmost switch () , touch for more than two seconds to turn on the monitor.
3. Select "Key Lock" in "Administrator Settings", then select .
4. Use or to select "Off", "Menu", or "All", then select .

Setting	Lockable switches
Off	None (All switches are enabled.)
Menu	Adjust or set using the Setting menu.
All	All switches except <input type="checkbox"/>

5. Select "Apply" and then .









Note

- After calibration is performed using RadiCS / RadiCS LE, "Menu" is selected.

5.10 Setting Whether to Display / Hide the Grayscale Warning

You can specify whether to display the Grayscale Display Error message to indicate that a 6-bit (64-grayscale) signal has been detected when the DisplayPort signal is input at the recommended resolution. If the error message appears, please turn off the main power, and then turn it on again.





<p>Attention</p> <ul style="list-style-type: none"> • Always use with this set to "On" (the default setting is "On"). • Set this to "Off" only when using 6-bit (64 grayscale) display.
--

1. Select  to turn off the monitor.
2. While touching the leftmost switch () , touch  for more than two seconds to turn on the monitor.
3. Select "Grayscale Warning" in "Administrator Settings", then select .
4. Use  or  to select either "On" or "Off" and then select .
5. Select "Apply" and then .

5.11 Acquiring Life Estimation Data

You can acquire data required to estimate the monitor’s lifespan. The life estimation result based on the acquired data can be confirmed using RadiCS / RadiCS LE.

<p>Note</p> <ul style="list-style-type: none"> • Data is collected every 100 hours. • If you selected "Power Save" and 100 hours have elapsed, the data collection process runs when the monitor enters the power saving mode or the power is turned off. • If "Routine" or "Power Save" is selected, the Integrated Front Sensor starts measurement at the time of data collection. If "Off" is selected, measurement using the Integrated Front Sensor is not performed at the time of data collection. • The collected data is saved at the following timings: <ul style="list-style-type: none"> – 500, 1000, 2000, 4000, 7000, 10000, 15000, 20000, 25000, and 30000 hours.

1. Select "RadiCS SelfQC" from the Setting menu, then select .
2. Select "LEA" in "RadiCS SelfQC", then select .
3. Select "Meas. Frequency".
4. Use  or  to select "Power Save", "Routine", or "Off", then select .

5.12 Viewing the Monitor Information

View information related to the input signals that are currently displayed and the monitor.

1. Select "Information" from the Setting menu, then select .

Input signal information, model name, serial number, firmware version, and usage time are displayed.

The asset tag number is only displayed when it has been set using RadiCS / RadiCS LE.

Example:

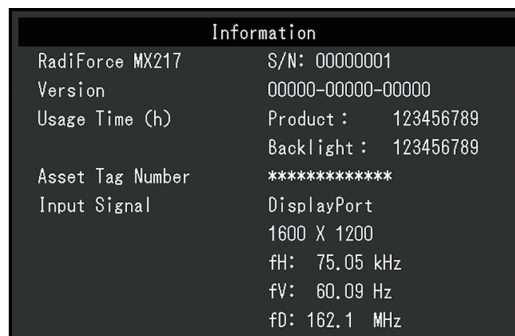

Attention

- The usage time may not be "0" at the time of your purchase because inspections and other processes had been carried out on the monitor before it was shipped from the factory.

5.13 Resetting to Defaults

There are two different reset functions: One that only resets the color adjustments to default settings, and the other that resets all settings to defaults.

Attention

- The previous settings cannot be recovered after they were reset to defaults.

Note

- For details on default settings, see [7.3 Main Default Settings \[▶ 29\]](#).

5.13.1 Resetting the color adjustment value

Only the color adjustment value for the currently selected mode is reset to the default setting.

1. Select "CAL Switch Mode" from the Setting menu, then select .
2. Select "Reset" and then .
3. Select "OK" and then .

The color adjustment value reverts to the default setting.

5.13.2 Resetting all settings

Restore all settings to their default values (except for "Input" and "Administrator Settings").

1. Select "Preferences" from the Setting menu, then select .
2. Select "Monitor Reset" in "Preferences", then select .
3. Use or to select "OK", then select .

All settings except for "Input" and "Administrator Settings" are reset to defaults.

6 Troubleshooting

6.1 No Picture

Power switch indicator does not light up

- Check whether the power cord is connected properly.
- Turn the main power switch on.
- Touch .
- Turn off the main power, and then turn it on again.

Power switch indicator lights up: Green

- Increase "Brightness", "Contrast", or "Gain" in the Setting menu (cannot be adjusted in 1-DICOM, 2-CAL1, 3-CAL2 modes). (See [2.4 Adjusting Brightness / Colors](#) [▶ 10].)
- Turn off the main power, and then turn it on again.

Power switch indicator lights up: Orange

- Try switching the input signal (see [2.2 Setting the Input Signal](#) [▶ 9]).
- Move the mouse or press any key on the keyboard.
- Check whether the PC is turned on.
- Check whether the signal cable is connected properly. Connect the signal cables to the connectors of the corresponding input signal. Connect the signal cable to the DisplayPort input connector when inputting a DisplayPort signal. The DisplayPort output connector is used for output when a daisy-chain connection is set up.
- Turn off the main power, and then turn it on again.

Power switch indicator blinks: Orange, Green

- Connect via the signal cable specified by EIZO. Turn off the main power, and then turn it on again.
- If the signal cable is connected to DisplayPort, try switching the DisplayPort version (see [5.4 Setting the Version for DisplayPort Input](#) [▶ 18]).

The message "No Signal" appears in the screen.

Example:



- The message shown above may appear, because some PCs do not output the signal immediately after power-on.
- Check whether the PC is turned on.
- Check whether the signal cable is connected properly. Connect the signal cables to the connectors of the corresponding input signal. Connect the signal cable to the DisplayPort input connector when inputting a DisplayPort signal. The DisplayPort output connector is used for output when a daisy-chain connection is set up.
- Try switching the input signal (see [2.2 Setting the Input Signal](#) [▶ 9]).
- If the signal cable is connected to DisplayPort, try switching the DisplayPort version (see [5.4 Setting the Version for DisplayPort Input](#) [▶ 18]).

- Turn off the main power, and then turn it on again.

The message "Signal Error" appears on the screen

Example:

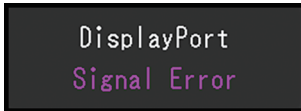

- Check whether the PC is configured to meet the resolution and vertical scan frequency requirements of the monitor (see "Compatible Resolutions" in the Instructions for Use).
- Reboot the PC.
- Select an appropriate setting using the graphics board's utility. Refer to the User's Manual of the graphics board for details.

6.2 Imaging Problems

The screen is too bright or too dark

- Adjust "Brightness", "Contrast" in the Setting menu (cannot be adjusted in 1-DICOM, 2-CAL1, 3-CAL2 modes). (The LCD monitor backlight has a limited life span. When the screen becomes dark or begins to flicker, contact your local EIZO representative.)

Text is blurred

- Check whether the PC is configured to meet the resolution and vertical scan frequency requirements of the monitor (see "Compatible Resolutions" in the User's Manual).
- Try setting the magnification of display on the OS to "100 %". When using multiple monitors, try setting the magnification of display to "100 %" on all monitors.

An afterimage can be seen

- Afterimages are particular to LCD monitors. Avoid displaying the same image for a long time.
- Use the screen saver or power save function if you are going to be displaying the same image for extended periods of time.
- An afterimage may appear even after a short time period has elapsed depending on the displayed image. To remove such a phenomenon, change the image or keep the power turned off for several hours.

Green, red, blue, or white dots remain on the screen / Some dots do not light up

- This is common with LCD panels, and is not a malfunction.

Interference patterns or pressure marks remain on the LCD panel

- Leave the monitor with a white or black screen. The symptom may disappear.

6.3 Other Problems

The Setting menu does not appear

- Check whether the operation switch lock function is active (see [5.9 Locking Operation Switches](#) ▶ 20]).

The Mode menu does not appear

- Check whether the operation switch lock function is active (see [5.9 Locking Operation Switches \[▶ 20\]](#)).

The operation switches do not work

- Check whether the operation switch lock function is active (see [5.9 Locking Operation Switches \[▶ 20\]](#)).
- Check whether there are any water droplets or foreign objects on the switch surface. Gently wipe the switch surface and try operating the switches again with dry hands.
- Are you wearing gloves? If so, remove the gloves and try operating the switches again with dry hands.

The monitor connected using the USB cable is not detected or the USB device (peripheral) connected to the monitor does not work

- Check whether the USB cable is connected correctly (see [7.2 Using the USB Hub Function \[▶ 28\]](#)).
- Try using a different USB port on the PC.
- Try changing to a different USB port on the monitor.
- Reboot the PC.
- If the peripheral devices work normally when directly connected to the PC, contact your dealer or local EIZO representative.
- Check whether the PC and OS are USB compliant. (Contact the manufacturer of each device for information about USB compatibility.)
- Check the computer's BIOS (UEFI) setting for USB when using Windows. (Refer to the manual of the computer for details.)

The Integrated Front Sensor stays out.

- Turn off the main power, and then turn it on again.

RadiCS takes a long time to start up.

- Connect the included USB cable.

RadiCS fails to connect to the monitor

- Check that the USB cable is not pulled out.

SelfCalibration / Grayscale Check fails.

- Refer to [6.4 Error Code Table \[▶ 26\]](#).
- If an error code that does not appear in the error code table is displayed, contact your dealer or local EIZO representative.

Attention
<ul style="list-style-type: none"> • Do not touch the Integrated Front Sensor.

The SelfCalibration / Grayscale Check history does not display the clock time correctly.

- Perform monitor detection using RadiCS / RadiCS LE. For details, refer to the RadiCS / RadiCS LE User's Manual.

6.4 Error Code Table

Error Code	Description
****50	<ul style="list-style-type: none"> • The maximum brightness of the monitor may be lower than the target brightness. • Try reducing the target brightness.
****52	<ul style="list-style-type: none"> • The minimum brightness of the monitor may be higher than the target minimum brightness. • Try increasing the target minimum brightness.
****05	<ul style="list-style-type: none"> • The sensor may not have worked correctly. • Turn off the main power, wait for a few minutes, turn the power back on, and then run SelfCalibration / Grayscale Check again.
****20 ****21	<ul style="list-style-type: none"> • The sensor may not have worked correctly. • Check whether there is any foreign object near the sensor. • Run SelfCalibration / Grayscale Check again.

7 Reference

7.1 Attaching an Optional Arm

An optional arm (or an optional stand) can be attached by removing the stand section. Please refer to our web site for the supported optional arm (or optional stand).

(www.eizoglobal.com)

Attention

- When attaching an arm or stand, follow the instructions of the respective User's Manual.
- When using another manufacturer's arm or stand, confirm the following in advance and select one conforming to the VESA standard.
 - Clearance between the screw holes: 100 mm x 100 mm
 - Arm/stand VESA mount dimensions: 122 mm x 122 mm or less
 - Strong enough to support weight of the monitor unit (excluding the stand) and attachments such as cables
- When using another manufacturer's arm or stand, use the following screws to secure it.
 - Screws fixing the stand to the monitor
- When using an arm or stand, attach it to meet the following tilt angles of the monitor.
 - Up 45°, down 45° (when the monitor is in portrait orientation, or when it is rotated 90° counterclockwise to a landscape orientation)
- Connect the cables after attaching an arm or stand.
- Do not move the removed stand up and down. Doing so may result in injury or device damage.
- The monitor and arm/stand are heavy. Dropping them may result in injury or equipment damage.
- Periodically check the tightness of the screws. If not sufficiently tight, the monitor may detach from the arm, which may result in injury or equipment damage.

1. In order to prevent the LCD panel surface from being scratched, lay the monitor on a soft cloth spread on a stable surface with the LCD panel surface facing down.
2. Prepare a screwdriver. Using a screwdriver, remove the screws (four) securing the unit and the stand.
3. Use the screws that you removed in step 2 to attach the arm (or stand) to the monitor.

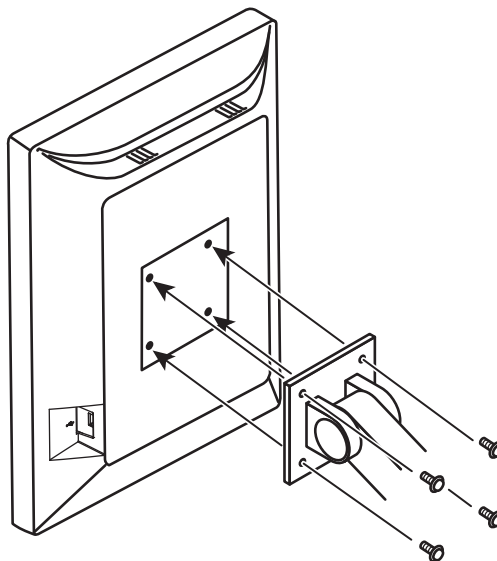

7.2 Using the USB Hub Function

This monitor is equipped with a USB hub. Connected to a PC compatible with USB or another monitor with a USB hub, this monitor functions as a USB hub allowing connection to peripheral USB devices.

1. Connect the supplied USB cable between the USB downstream port of a PC (or another monitor that has a USB hub) and the monitor's USB upstream port.
2. Connect the peripheral USB device to the USB downstream port of the monitor.

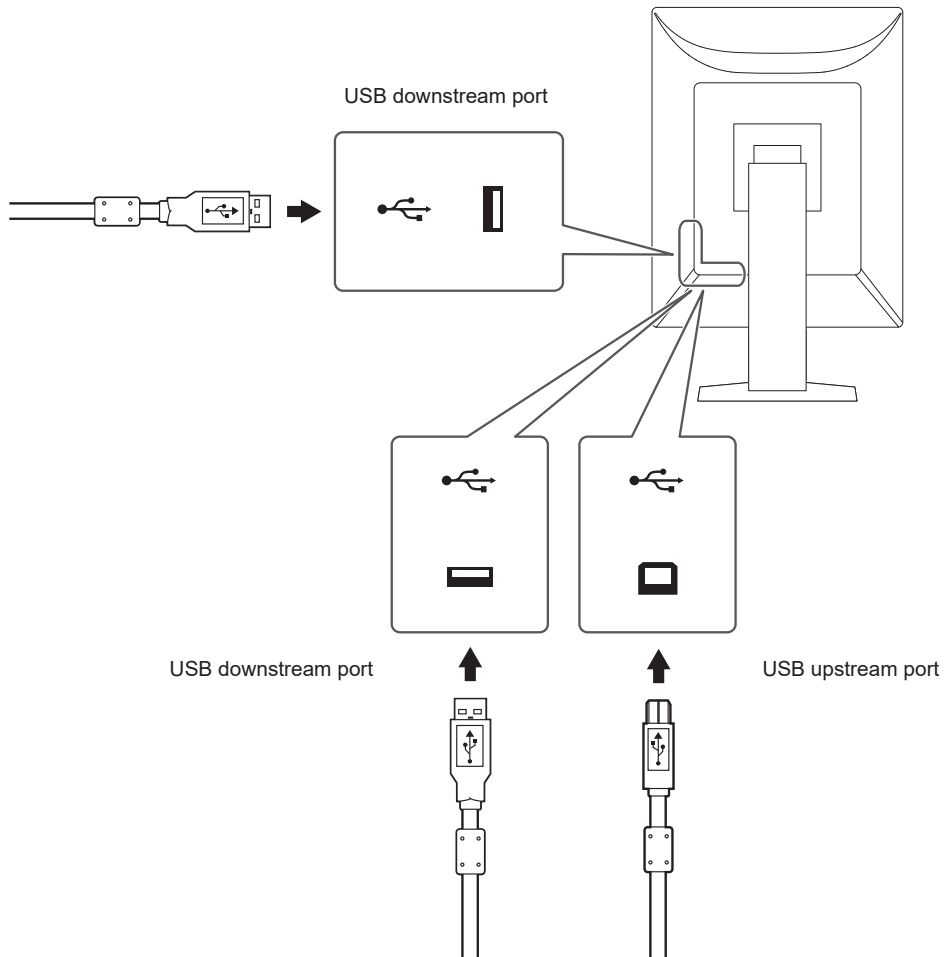

Attention

- When the main power switch is turned off, a device connected to the USB downstream port will not work.

7.3 Main Default Settings

7.3.1 CAL Switch Mode

Factory default display setting is "1-DICOM".

Mode	Brightness	Temperature	Gamma	Hybrid Gamma PXL
1-DICOM	270 cd/m ²	7500 K	DICOM GSDF	Off
2-CAL1	270 cd/m ²	7500 K	2.2	Off
3-CAL2	180 cd/m ²	7500 K	DICOM GSDF	Off
4-Custom	Approx. 180 cd/m ²	7500 K	2.2	- (Disable)
5-sRGB	Approx. 180 cd/m ²	sRGB	sRGB	- (Disable)
6-Text	Approx. 100 cd/m ²	6500 K	2.2	- (Disable)

7.3.2 Others

LEA	Power Save
Warning	Off
QC History	On
Picture Expansion	Dot by Dot
Input	DisplayPort ^{*1}
Auto Input Detection	Off
Power Save	High
Indicator	4
Mode Skip	- (Display all)
Languages	English
Key Lock	Off ^{*1}
Image Rotation	Portrait ^{*1}
DP Power Save	Off ^{*1}
Grayscale Warning	On ^{*1}
Sharpness Recovery	On ^{*1}
DisplayPort	Version 1.2 ^{*1}

*1 These menus cannot be initialized by executing "Monitor Reset" (see [Resetting all settings](#) [▶ 22]).

Appendix

Trademark

The terms HDMI and HDMI High-Definition Multimedia Interface, and the HDMI Logo are trademarks or registered trademarks of HDMI Licensing, LLC in the United States and other countries.

The DisplayPort Compliance Logo and VESA are registered trademarks of the Video Electronics Standards Association.

The SuperSpeed USB Trident Logo is a registered trademark of USB Implementers Forum, Inc.



The USB Power Delivery Trident Logos are trademarks of USB Implementers Forum, Inc.



USB Type-C and USB-C are registered trademarks of USB Implementers Forum, Inc.

DICOM is the registered trademark of the National Electrical Manufacturers Association for its standards publications relating to digital communications of medical information.

Kensington and Microsaver are registered trademarks of ACCO Brands Corporation.

Thunderbolt is a trademark of Intel Corporation in the United States and/or other countries.

Microsoft and Windows are registered trademarks of Microsoft Corporation in the United States and other countries.

Adobe is a registered trademark of Adobe in the United States and other countries.

Apple, macOS, Mac OS, OS X, macOS Sierra, Macintosh, and ColorSync are registered trademarks of Apple Inc.

ENERGY STAR is a registered trademark of the United States Environmental Protection Agency in the United States and other countries.

EIZO, the EIZO Logo, ColorEdge, CuratOR, DuraVision, FlexScan, FORIS, RadiCS, RadiForce, RadiNET, Raptor, and ScreenManager are registered trademarks of EIZO Corporation in Japan and other countries.

ColorEdge Tablet Controller, ColorNavigator, EcoView NET, EIZO EasyPIX, EIZO Monitor Configurator, EIZO ScreenSlicer, G-Ignition, i•Sound, Quick Color Match, RadiLight, Re/Vue, SafeGuard, Screen Administrator, Screen InStyle, ScreenCleaner, SwitchLink, and UniColor Pro are trademarks of EIZO Corporation.

All other company names, product names, and logos are trademarks or registered trademarks of their respective owners.

License

The bitmap font used for this product is designed by Ricoh Industrial Solutions Inc.

LIMITED WARRANTY

EIZO Corporation (hereinafter referred to as “EIZO”) and distributors authorized by EIZO (hereinafter referred to as the “Distributors”) warrant, subject to and in accordance with the terms of this limited warranty (hereinafter referred to as the “Warranty”), to the original purchaser (hereinafter referred to as the “Original Purchaser”) who purchased the product specified in this document (hereinafter referred to as the “Product”) from EIZO or Distributors, that EIZO and Distributors shall, at their sole discretion, either repair or replace the Product at no charge if the Original Purchaser becomes aware within the Warranty

Period (defined below) that (i) the Product malfunctions or is damaged in the course of normal use of the Product in accordance with the description in the instruction manual of the Product (hereinafter referred to as the "User's Manual"), or (ii) the LCD panel and brightness of the Product cannot maintain the recommended brightness specified in the User's Manual in the course of normal use of the Product in accordance with the description of the User's Manual.

The period of this Warranty is five (5) years from the date of purchase of the Product (hereinafter referred to as the "Warranty Period").

However, the brightness of the Product shall be warranted only if the Product has been used within the recommended brightness described in the User's Manual.

The Warranty Period for the brightness is also limited to five (5) years from the date of purchase of the Product subject to the usage time being less than or equal to 10,000 hours (the brightness is 270 cd/m² and color temperature is 7500K).

EIZO and Distributors shall bear no liability or obligation with regard to the Product in relation to the Original Purchaser or any third parties other than as provided under this Warranty.

EIZO and Distributors will cease to hold or store any parts (excluding design parts) of the Product upon expiration of seven (7) years after the production of the Product is discontinued.

In repairing the Product, EIZO and Distributors will use renewal parts which comply with our QC standards. If the unit cannot be repaired due to its condition or the stockout of a relevant part, EIZO and Distributors may offer the replacement by a product with equivalent performance instead of repairing it.

The Warranty is valid only in the countries or territories where the Distributors are located. The Warranty does not restrict any legal rights of the Original Purchaser.

Notwithstanding any other provision of this Warranty, EIZO and Distributors shall have no obligation under this Warranty whatsoever in any of the cases as set forth below:

1. Any defect of the Product caused by freight damage, modification, alteration, abuse, misuse, accident, incorrect installation, disaster, adherent dust, faulty maintenance and/or improper repair by third party other than EIZO and Distributors;
2. Any incompatibility of the Product due to possible technical innovations and/or regulations;
3. Any deterioration of the sensor, including measurement value of the sensor;
4. Any defect of the Product caused by external equipments;
5. Any defect of the Product caused by the use under environmental conditions not anticipated by EIZO;
6. Any deterioration of the attachments of the Product (e.g. cables, User's Manual, CD-ROM, etc.);
7. Any deterioration of the consumables, and/or accessories of the Product (e.g. batteries, remote controller, touch pen, etc.);
8. Any exterior deterioration or discoloration of the Product, including that of the surface of the LCD panel, the touch panel and the protect panel;
9. Any defect of the Product caused by placement in a location where it may be affected by strong vibrations or shocks;
10. Any defect of the Product caused by leaking battery liquid;
11. Any deterioration of the Product caused by the use at higher brightness than the recommended brightness described in the User's Manual;
12. Any deterioration of display performance caused by the deterioration of expendable parts such as the LCD panel and/or backlight, etc. (e.g. changes in brightness

uniformity, changes in color, changes in color uniformity, defects in pixels including burnt pixels, etc.);

13. Any deterioration or malfunction of the cooling fan caused by adherent dust.

To obtain service under the Warranty, the Original Purchaser must deliver the Product, freight prepaid, in its original package or other adequate package affording an equal degree of protection, assuming the risk of damage and/or loss in transit, to the local Distributor. The Original Purchaser must present proof of purchase of the Product and the date of such purchase when requesting services under the Warranty.

The Warranty Period for any replaced and/or repaired product under this Warranty shall expire at the end of the original Warranty Period.

EIZO OR DISTRIBUTORS ARE NOT RESPONSIBLE FOR ANY DAMAGE TO, OR LOSS OF, DATA OR OTHER INFORMATION STORED IN ANY MEDIA OR ANY PART OF ANY PRODUCT RETURNED TO EIZO OR DISTRIBUTORS FOR REPAIR.

EIZO AND DISTRIBUTORS MAKE NO FURTHER WARRANTIES, EXPRESSED OR IMPLIED, WITH RESPECT TO, INCLUDING, WITHOUT LIMITATION, THE PRODUCT AND ITS QUALITY, PERFORMANCE, MERCHANTABILITY OR FITNESS FOR ANY PARTICULAR USE.

IN NO EVENT SHALL EIZO OR DISTRIBUTORS BE LIABLE FOR ANY INCIDENTAL, INDIRECT, SPECIAL, CONSEQUENTIAL OR OTHER DAMAGE WHATSOEVER (INCLUDING, WITHOUT LIMITATION, DAMAGES FOR LOSS OF PROFIT, BUSINESS INTERRUPTION, LOSS OF BUSINESS INFORMATION, OR ANY OTHER PECUNIARY LOSS) ARISING OUT OF THE USE OR INABILITY TO USE THE PRODUCT OR IN ANY CONNECTION WITH THE PRODUCT, WHETHER BASED ON CONTRACT, TORT, NEGLIGENCE, STRICT LIABILITY OR OTHERWISE, EVEN IF EIZO OR DISTRIBUTORS HAVE BEEN ADVISED OF THE POSSIBILITY OF SUCH DAMAGES.

THIS EXCLUSION ALSO INCLUDES ANY LIABILITY WHICH MAY ARISE OUT OF THIRD PARTY CLAIMS AGAINST THE ORIGINAL PURCHASER. THE ESSENCE OF THIS PROVISION IS TO LIMIT THE POTENTIAL LIABILITY OF EIZO AND DISTRIBUTORS ARISING OUT OF THIS LIMITED WARRANTY AND/OR SALES.

