

# User's Manual

# FlexScan® S2202W

Color LCD Monitor

## Important

Please read PRECAUTIONS, this User's Manual, and the Setup Guide (separate volume) carefully to familiarize yourself with safe and effective usage.

- Please refer to the Setup Guide for basic information ranging from connection of the monitor to a PC to using the monitor.
- The latest User's Manual is available for download from our web site:  
<http://www.eizo.com>

## CONTENTS

### Chapter 1 Features and Overview

- 1-1 Features
- 1-2 Controls and Functions
- 1-3 Compatible Resolutions/Frequencies
- 1-4 Functions and Basic Operation

### Chapter 2 Settings and Adjustments

- 2-1 Utility Disk
- 2-2 Screen Adjustment
- 2-3 Color Adjustment
- 2-4 Adjusting Volume
- 2-5 Turning off the audio output at Power Saving mode
- 2-6 Setting On/Off for the automatic brightness adjustment function
- 2-7 Setting On/Off for Power Saving mode
- 2-8 Turning off the monitor automatically
- 2-9 Displaying the level of power saving by EcoView Index
- 2-10 Setting Adjustment Menu Display
- 2-11 Setting Orientation
- 2-12 Locking Buttons
- 2-13 Displaying Monitor Information
- 2-14 Enabling/Disabling DDC/CI communication
- 2-15 Setting Power Indicator ON/OFF
- 2-16 Setting Language
- 2-17 Setting EIZO logo display ON/OFF
- 2-18 Resuming the Default Setting

### Chapter 3 Connecting Cables

- 3-1 Connecting Two PCs to the Monitor
- 3-2 Adjusting the DVI Input Level

### Chapter 4 Troubleshooting

### Chapter 5 Reference

- 5-1 Attaching an Arm
- 5-2 Specifications
- 5-3 Glossary
- 5-4 Preset Timing



## [Location of Caution Statement]

Ex. Height adjustable stand

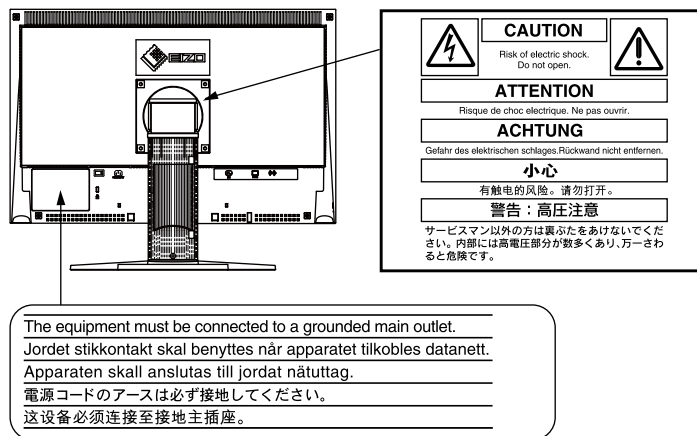

As an ENERGY STAR Partner, EIZO NANA O CORPORATION has determined that this product meets the ENERGY STAR guidelines for energy efficiency.



This product has acquired the TCO standard that relates to the safety, ergonomics, environment and so forth of office equipment. For an overview of the TCO, refer to our web site.

<http://www.eizo.com>

This product has been adjusted specifically for use in the region to which it was originally shipped. If operated outside this region, the product may not perform as stated in the specifications.

---

Copyright© 2010-2012 EIZO NANA O CORPORATION All rights reserved.

No part of this manual may be reproduced, stored in a retrieval system, or transmitted, in any form or by any means, electronic, mechanical, or otherwise, without the prior written permission of EIZO NANA O CORPORATION.

EIZO NANA O CORPORATION is under no obligation to hold any submitted material or information confidential unless prior arrangements are made pursuant to EIZO NANA O CORPORATION's receipt of said information.

Although every effort has been made to ensure that this manual provides up-to-date information, please note that EIZO monitor specifications are subject to change without notice.

---

VESA is a registered trademark or a trademark of the Video Electronics Standards Association in the United States and other countries. Windows, Windows Vista, Windows Media, SQL Server, and Xbox 360 are registered trademarks of Microsoft Corporation in the United States and other countries.

Apple, Mac, Macintosh, iMac, eMac, Mac OS, MacBook, PowerBook, ColorSync, QuickTime, and iBook are registered trademarks of Apple Inc.

ENERGY STAR is a registered trademark of the United States Environmental Protection Agency in the United States and other countries.

EIZO, the EIZO Logo, ColorEdge, DuraVision, FlexScan, FORIS, RadiForce, RadiCS, RadiNET, Raptor, and ScreenManager are registered trademarks of EIZO NANA O CORPORATION in Japan and other countries.

ColorNavigator, EIZO EasyPIX, EcoView NET, EIZO ScreenSlider, i • Sound, Screen Administrator, and UniColor Pro are trademarks of EIZO NANA O CORPORATION.

All other company and product names are trademarks or registered trademarks of their respective owners.

## Notice for this monitor

---

This product is suited to general purposes like creating documents, viewing multimedia content.

---

This product has been adjusted specifically for use in the region to which it was originally shipped. If the product is used outside the region, it may not operate as specified in the specifications.

---

This product may not be covered by warranty for uses other than those described in this manual.

---

The specifications noted in this manual are only applicable when the following are used:

- Power cords provided with the product
  - Signal cables specified by us
- 

Only use optional products manufactured or specified by us with this product.

---

As it takes about 30 minutes for the performance of electrical parts to stabilize, adjust the monitor 30 minutes or more after the monitor power has been turned on.

---

Monitors should be set to a lower brightness to reduce changes in luminosity caused by long-term use and maintain a stable display.

---

When the screen image is changed after displaying the same image for extended periods of time, an afterimage may appear. Use the screen saver or power save function to avoid displaying the same image for extended periods of time.

---

Periodic cleaning is recommended to keep the monitor looking new and to prolong its operation lifetime (refer to “Cleaning” on [page 2](#)).

---

The LCD panel is manufactured using high-precision technology. Although, missing pixels or lit pixels may appear on the LCD panel, this is not a malfunction. Percentage of effective dots: 99.9994% or higher.

---

The backlight of the LCD panel has a fixed lifetime. When the screen becomes dark or begins to flicker, please contact your dealer.

---

Do not press on the panel or edge of the frame strongly, as this may result in display malfunctions, such as interference patterns, etc. If pressure is continually applied to the panel, it may deteriorate or damage your panel. (If the pressure marks remain on the panel, leave the monitor with a black or white screen. The symptom may disappear.)

---

Do not scratch or press on the panel with any sharp objects, as this may result in damage to the panel. Do not attempt to brush with tissues as this may scratch the panel.

---

When the monitor is cold and brought into a room or the room temperature goes up quickly, dew condensation may occur on the interior and exterior surfaces of the monitor. In that case, do not turn the monitor on. Instead wait until the dew condensation disappears, otherwise it may cause some damage to the monitor.

---

---

## Cleaning

---

### Attention

- Chemicals such as alcohol and antiseptic solution may cause gloss variation, tarnishing, and fading of the cabinet or panel, and also quality deterioration of the image.
  - Never use any thinner, benzene, wax, and abrasive cleaner, which may damage the cabinet or panel.
- 

### Note

- The optional ScreenCleaner is recommended for cleaning the cabinet and panel surface.
- 

If necessary, the stains on the cabinet and panel surface can be removed by moistening part of a soft cloth with water.

## To use the monitor comfortably

---

- An excessively dark or bright screen may affect your eyes. Adjust the brightness of the monitor according to the environmental conditions.
- Staring at the monitor for a long time tires your eyes. Take a 10-minute rest every hour.

# CONTENTS

Notice for this monitor .....	1	2-9	Displaying the level of power saving by EcoView Index.....	19
<b>CONTENTS .....</b>	<b>3</b>	2-10	<b>Setting Adjustment Menu Display .....</b>	<b>19</b>
<b>Chapter 1 Features and Overview .....</b>	<b>4</b>	<ul style="list-style-type: none"><li>To update menu settings [Menu Size/Menu Position/Menu Off Timer/Translucent] .....</li></ul>	19	
1-1 Features .....	4	2-11	Setting Orientation .....	20
1-2 Controls and Functions .....	5	<ul style="list-style-type: none"><li>To set the orientation of the Adjustment menu [Orientation].....</li></ul>	20	
1-3 Compatible Resolutions/Frequencies .....	6	2-12	Locking Buttons .....	20
1-4 Functions and Basic Operation.....	7	2-13	Displaying Monitor Information [Information].....	21
<b>Chapter 2 Settings and Adjustments .....</b>	<b>10</b>	2-14	Enabling/Disabling DDC/CI communication [DDC/CI] .....	21
2-1 Utility Disk .....	10	2-15	Setting Power Indicator ON/OFF [Power Indicator] .....	21
<ul style="list-style-type: none"><li>Disk contents and software overview .....</li></ul>	10	2-16	Setting Language [Language] .....	21
2-2 Screen Adjustment .....	11	2-17	Setting EIZO logo display ON/OFF.....	22
Digital Input.....	11	2-18	Resuming the Default Setting [Reset] .....	22
Analog Input .....	11	<ul style="list-style-type: none"><li>To reset color adjustment values.....</li><li>To reset all adjustments to the factory default settings.....</li></ul>	22	
2-3 Color Adjustment.....	14	<b>Chapter 3 Connecting Cables .....</b>	<b>23</b>	
<ul style="list-style-type: none"><li>To select the display mode (FineContrast mode) .....</li><li>To perform advanced adjustments .....</li><li>Adjustment items in each mode .....</li><li>To adjust the brightness [Brightness] .....</li><li>To adjust the contrast [Contrast].....</li><li>To adjust the color temperature [Temperature].....</li><li>To adjust the gamma value [Gamma].....</li><li>To adjust the color saturation [Saturation].....</li><li>To adjust the hue [Hue] .....</li><li>To adjust the gain value [Gain].....</li></ul>	14-17	3-1	Connecting Two PCs to the Monitor .....	23
2-4 Adjusting Volume [Volume] .....	17	<ul style="list-style-type: none"><li>To switch the input signal .....</li><li>To set input signal selection [Input Signal] .....</li></ul>	23-24	
2-5 Turning off the audio output at Power Saving mode [Power Save].....	17	3-2	Adjusting the DVI Input Level [DVI Input Level] .....	24
2-6 Setting On/Off for the automatic brightness adjustment function [Auto EcoView] .....	18	<b>Chapter 4 Troubleshooting.....</b>	<b>25</b>	
2-7 Setting On/Off for Power Saving mode [Power Save] .....	18	<b>Chapter 5 Reference .....</b>	<b>27</b>	
2-8 Turning off the monitor automatically [Off Timer] .....	19	5-1	Attaching an Arm .....	27
		5-2	Specifications .....	28
		5-3	Glossary .....	33
		5-4	Preset Timing.....	35

# Chapter 1 Features and Overview

Thank you very much for choosing an EIZO color LCD monitor.

## 1-1 Features

- 22" wide format LCD Applicable to WSXGA+ (1680×1050)
- Built-in speakers and headphone jack
  - 1-2 "Controls and Functions" ([page 5](#))
- Power saving function
  - Suppressing the power consumption\* reduces the carbon dioxide emissions.
  - This product is equipped with various power saving functions.
  - \* Reference values: Maximum power consumption: 47W (Luminance Max., at default settings)  
Standard power consumption: 23W (Luminance 120cd/m<sup>2</sup>, at default settings)
  - Power Consumption when main power switch is Off: 0W
    - Equipped with main power switch.
    - Turning off the main power switch completely shuts off power supply to the monitor while the monitor is not used.
  - Auto EcoView function
    - The sensor on the front side of the monitor detects the environmental brightness to adjust the screen brightness automatically and comfortably.
    - Excessively high brightness may lead a damage to the natural environment as well as to your eyes. Suppressing the excessively high brightness will be helpful to reduce the power consumption and the damage to your eyes.
    - 2-6 "Setting On/Off for the automatic brightness adjustment function [Auto EcoView]" ([page 18](#))
  - EcoView Index function
    - The green indicator shows the power consumption ratio responding to the brightness of the monitor. You can realize the power consumption reduction by taking consideration in the ratio of power saving.
    - 2-9 "Displaying the level of power saving by EcoView Index" ([page 19](#))
- FineContrast function
  - 2-3 "To select the display mode (FineContrast mode)" ([page 14](#))
- Applicable to DVI long cable
  - 3-2 "Adjusting the DVI Input Level [DVI Input Level]" ([page 24](#))
- Portrait/Landscape display available (For height adjustable stand and EZ-UP stand only)
- The utility software "ScreenManager Pro for LCD (DDC/CI)" to control the monitor from a PC with mouse/keyboard is included
  - 2-1 "Utility Disk" ([page 10](#))
- HDCP (High-bandwidth Digital Content Interface)

### Note

- This monitor supports the Portrait/Landscape display. This function allows you to change the orientation of the Adjustment menu when using the monitor screen in vertical display position. (Refer to "To set the orientation of the Adjustment menu [Orientation]" on [page 20](#).)
- If you use the monitor with "Portrait" position, the setting may be required to change depending on the graphics board used in your PC. Refer to the manual of the graphics board for details.
- The stand of the unit can be replaced with an arm or another stand. (Refer to "5-1 Attaching an Arm" on [page 27](#).)

# 1-2 Controls and Functions

Ex. Height adjustable stand

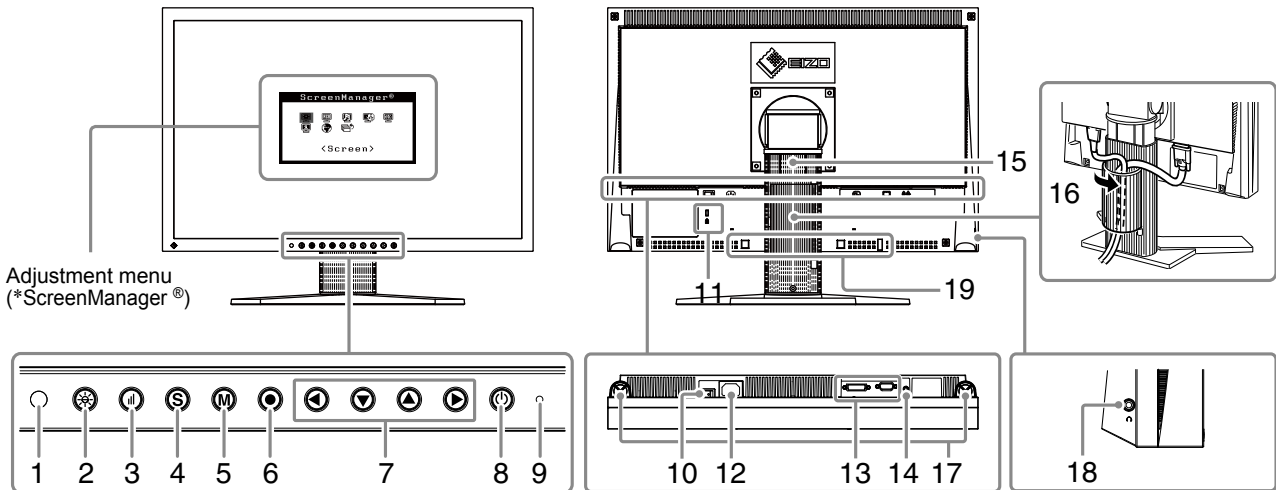

1	<b>Sensor</b>	Detects ambient brightness. Auto EcoView function (page 18).
2	<b>Auto EcoView button</b>	Allows you to switch the Auto EcoView function On or Off (page 18).
3	<b>EcoView Index button</b>	Displays the EcoView index (page 19).
4	<b>Input Signal Selection button</b>	Switches input signals for display when two PCs are connected to the monitor (page 23).
5	<b>Mode button</b>	Allows you to switch the display mode (page 14).
6	<b>Enter button</b>	Displays the Adjustment menu, determines an item on the menu screen, and saves values adjusted (page 9).
7	<b>Control buttons (Left, Down, Up, Right)</b>	<ul style="list-style-type: none"> <li>• Chooses an adjustment item or increases/decreases adjusted values for advanced adjustments using the Adjustment menu (page 9).</li> <li>• ◀ or ▶ button: Displays the volume adjustment menu (page 7).</li> <li>• ▲ or ▼ button: Displays the brightness adjustment menu (page 7).</li> </ul>
8	<b>Power button</b>	Turns the power on or off.
9	<b>Power indicator</b>	Indicates monitor's operation status. Blue: Operating      Orange: Power saving      Off: Power off
10	<b>Main Power Switch</b>	Turns the main power on or off.
11	<b>Security lock slot</b>	Complies with Kensington's MicroSaver security system.
12	<b>Power connector</b>	Connects the power connector.
13	<b>Input signal connectors</b>	DVI-I Connector/D-Sub mini 15-pin connector
14	<b>Stereo mini jack</b>	Connects the stereo mini jack cable.
15	<b>Stand</b>	Used to adjust the height (Height adjustable stand and EZ-UP stand only) and angle of the monitor screen.
16	<b>Cable holder</b>	Covers the monitor cables.
17	<b>Speaker</b>	Outputs audio source.
18	<b>Headphone jack</b>	Connects the headphones.
19	<b>Option speaker (i-Sound L3) mounting holes</b>	Used to attach the option speaker (i-Sound L3). (May not allowed to attach the option speaker depending on the stand type.)

\* ScreenManager® is an EIZO's nickname of the Adjustment menu. (For how to use ScreenManager, refer to the User's Manual on the CD-ROM.)

## 1-3 Compatible Resolutions/Frequencies

The monitor supports the following resolutions.

### Analog Input

Resolution	Frequency	Mode	Dot Clock
640 × 480	~75 Hz	VGA, VESA	150 MHz (Max.)
720 × 400	70 Hz	VGA TEXT	
800 × 600	~75 Hz	VESA	
1024 × 768	~75 Hz	VESA	
1152 × 864	75 Hz	VESA	
1280 × 960	60 Hz	VESA	
1280 × 1024	~75 Hz	VESA	
*1 *2 1680 × 1050	60 Hz	VESA CVT, VESA CVT RB	

### Digital Input

Resolution	Frequency	Mode	Dot Clock
640 × 480	60 Hz	VGA	120 MHz (Max.)
720 × 400	70 Hz	VGA TEXT	
800 × 600	60 Hz	VESA	
1024 × 768	60 Hz	VESA	
1280 × 960	60 Hz	VESA	
1280 × 1024	60 Hz	VESA	
*1 *2 1680 × 1050	60 Hz	VESA CVT RB	

\*1 Recommended resolution (Set this resolution)

\*2 When displaying the wide format input signal, a graphics board in conformance with VESA CVT standard is required.



# 1-4 Functions and Basic Operation

## To adjust the screen and color

● Main menu (Refer to [page 9](#) for operation)

[At analog signal input]

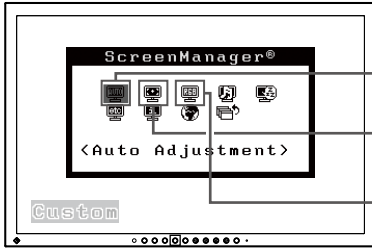

[At digital signal input]

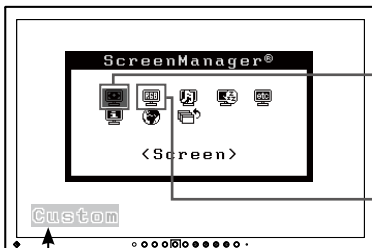

- The Adjustment menu and the FineContrast mode name cannot be displayed at the same time.

(M) FineContrast mode

### Color Adjustment

Page 14

#### Simple Adjustment [FineContrast mode]

This function allows easy selection of a desired mode from five modes according to monitor application.

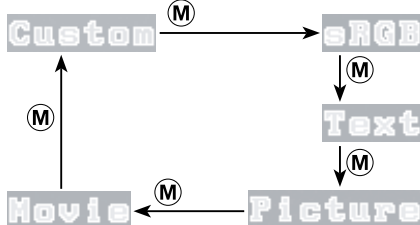

- To adjust the brightness [Brightness]  
Press or to adjust brightness.



- Adjusting Volume [Volume]  
Press or to adjust volume.



- Setting On/Off for the automatic brightness adjustment function [Auto EcoView]  
Press to switch the setting.
- Displaying the level of power saving by EcoView Index  
Press to display the level of power saving mode.



Analog input only

### 1 Screen Adjustment (Automatic Adjustment)

Page 11



- To adjust flickering and position  
[Screen]..... see [page 11](#)
- To adjust color gradation automatically  
[Range] ..... see [page 13](#)



### 2 Screen Adjustment (Advanced Adjustment)

Page 12

[At analog signal input]

[At digital signal input]

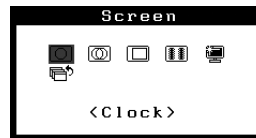

- To eliminate vertical bars [Clock\*] ... see [page 12](#)
- To remove flickering or blurring  
[Phase\*]..... see [page 12](#)
- To correct screen position  
[Position\*] ..... see [page 13](#)
- To modify blurred characters/lines  
[Smoothing] ..... see [page 13](#)
- To set when a noise appears on the screen  
[Signal Filter\*] ..... see [page 26](#)

\* Items marked with \* can be adjusted with analog input.

### Color Adjustment Advanced Adjustment

Page 15



- "Brightness", "Contrast", "Temperature", "Gamma", "Saturation", "Hue" and "Gain" can be set for each mode (Custom/sRGB/Text/Picture/Movie).  
Settable functions vary with the FineContrast mode.

#### Resuming the default settings

- To reset color adjustment values  
[Reset] ..... see [page 22](#)

# To make useful settings/adjustments

● Adjustment menu (Refer to [page 9](#) for operation)

## [At analog signal input]

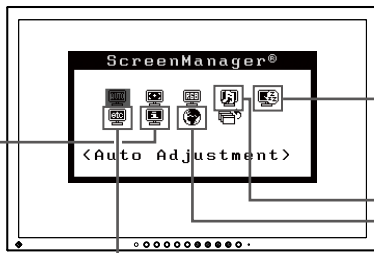

## [At digital signal input]

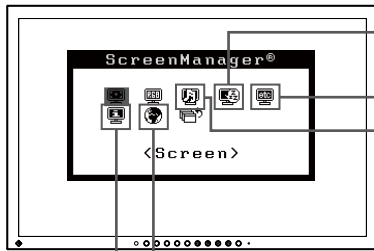

### Information

Page 21

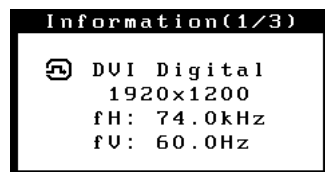

- Displaying Monitor Information [Information]

### Language

Page 21



- Setting Language [Language]

- Locking Buttons ..... see [page 20](#)
- Enabling/Disabling DDC/CI communication [DDC/CI] ..... see [page 21](#)
- Setting EIZO logo display ON/OFF ... see [page 22](#)
- Adjusting the DVI Input Level [DVI Input Level] ..... see [page 24](#)

### Power-save Settings



- Setting On/Off for Power Saving mode [Power Save] ..... see [page 18](#)
- Turning off the monitor automatically [Off Timer] ..... see [page 19](#)
- Displaying the level of power saving by EcoView Index [EcoView Index] ..... see [page 19](#)

### Other Settings



- To set input signal selection [Input Signal] ..... see [page 24](#)
- To update menu settings [Menu Size/Menu Position/Menu Off Timer/Translucent] ..... see [page 19](#)
- To set the orientation of the Adjustment menu [Orientation] ..... see [page 20](#)
- Setting Power Indicator ON/OFF [Power Indicator] ..... see [page 21](#)
- To reset all adjustments to the factory default settings [Reset] ..... see [page 22](#)

















### Sound Settings





- Turning off the audio output at Power Saving mode [Power Save]..... see [page 17](#)

## Basic operation of Adjustment menu



### [Displaying Adjustment menu and selecting function]

- (1) Press . The Main menu appears.
- (2) Select a function with  /  /  / , and press . The Sub menu appears.
- (3) Select a function with  /  /  / , and press . The adjustment/setting menu appears.
- (4) Adjust the selected item with  /  /  / , and press . The setting is saved.

### [Exiting Adjustment menu]

- (1) Choose <Return> from the Sub menu and press . The Main menu appears.
- (2) Choose <Exit> from the Main menu and press . The Adjustment menu quits.

#### Note

- The Adjustment menu can also be exited by pressing  twice quickly.
- <Exit> or <Return> can also be selected by pressing  twice in the Main menu or Sub menu.

# Chapter 2 Settings and Adjustments

## 2-1 Utility Disk

An “EIZO LCD Utility Disk” (CD-ROM) is supplied with the monitor. The following table shows the disk contents and the overview of the application software programs.

- **Disk contents and software overview**

The disk includes color profiles, application software programs for adjustment, and User’s Manual. Refer to “Readme.txt” or the “read me” file on the disk for software startup procedures or file access procedures.

Item	Overview	OS
A “Readme.txt” or “read me” file		
Color Profiles (ICC Profiles)	A specific file including the color characteristic information for the monitor. Used when performing the color management.	Windows 2000/XP/Vista Mac OS 9.2.2/X10.2 or later
Screen Adjustment Utility	Monitor pattern display software used when adjusting the image of the analog input signal manually.	Windows 2000/XP/Vista
Screen adjustment pattern files	Used when adjusting the image of the analog signal input manually. If the Screen Adjustment Utility is not applicable to your PC, use this pattern files to adjust the image.	
ScreenManager Pro for LCD (DDC/CI)	A software program to control monitor adjustments from a PC using its mouse and keyboard.	Windows Vista
EIZO ScreenSlicer	A software that divides a screen and lays out multiple windows efficiently.	Windows XP/Vista
User’s Manual of this monitor (PDF file)		

## 2-2 Screen Adjustment

### Digital Input

When digital signals are input, images are displayed correctly based on the preset data of the monitor. When performing the advanced adjustment, see “2-3 Color Adjustment” (page 14) and its subsequence pages.

### Analog Input

The monitor screen adjustment is used to suppress flickering of the screen or adjust screen position and screen size correctly according to the PC to be used.





**The auto adjust function works in the following cases:**

- When a signal is input into the monitor for the first time
- When the resolution or Vertical/Horizontal Frequency not displayed before is set

If the screen is not displayed correctly even after performing the auto adjustment, perform the screen adjustments according to the procedures on the following pages to use the monitor comfortably.

#### [Adjustment Procedure]

### 1 Perform the auto adjustment.

- **To adjust flickering, screen position, and screen size automatically [Screen]**
  - (1) Choose <Screen> from the <Auto Adjustment> menu, and press .  
The <Auto Adjustment> menu appears.
  - (2) Choose <Execute> with  or , and press .Flickering, screen position, and screen size are corrected by the auto-adjustment function.

### 2 Prepare the display pattern for the analog display adjustment.

- (1) Load the “EIZO LCD Utility Disk” to your PC.
- (2) For Windows PC: Start the “Screen Adjustment Utility” from the startup menu on the disk. If the “Screen Adjustment Utility” does not start, open the screen adjustment pattern files.  
For other than Windows PC: Use the screen adjustment pattern files.

**If the screen is not displayed correctly even after adjusting in step 1 above, perform the adjustments according to the procedures on the following pages. When the screen is displayed correctly, go to step 5 “To adjust color gradation automatically [Range]”.**

#### Attention

- Wait 30 minutes or more from monitor power on before starting adjustments.
- Auto adjust function does not work for the images under the resolution of 800 × 600 (SVGA).

#### Attention

- This function works correctly when an image is fully displayed over the Windows or Macintosh display area. It does not work properly when an image is displayed only on a part of the screen (command prompt window, for example) or when a black background (wallpaper, etc.) is in use.
- This function does not work correctly with some graphics boards.
- “Auto in Progress” appears on the screen during auto adjustment.

#### Note

- For how to open and use the screen adjustment pattern files, refer to “Readme.txt” or the “read me” file.

### 3 Perform the auto adjustment again with the analog screen adjustment pattern displayed.

- **To adjust flickering, screen position, and screen size automatically [Screen]**

- (1) Display Pattern 1 in full screen on the monitor using the “Screen Adjustment Utility” or the screen adjustment pattern files.

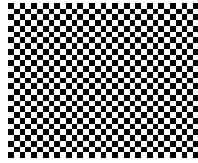

- (2) Choose <Screen> from the <Auto Adjustment> menu, and press .  
The <Auto Adjustment> menu appears.
- (3) Choose <Execute> with or , and press .  
Flickering, screen position, and screen size are corrected by the auto-adjustment function.

**If the screen is not displayed correctly even after adjusting in step 3 above, perform the adjustments according to the procedures on the following pages. When the screen is displayed correctly, go to step 5 “To adjust color gradation automatically [Range]”.**

### 4 Perform advanced adjustments for the following using the <Screen> menu of the Adjustment menu.

Adjust the clock, phase and position, in this order.

- **To eliminate vertical bars [Clock]**

- (1) Choose <Clock> from the <Screen> menu, and press .  
The <Clock> menu appears.
- (2) Adjust the clock with or , and press .  
The adjustment is completed.

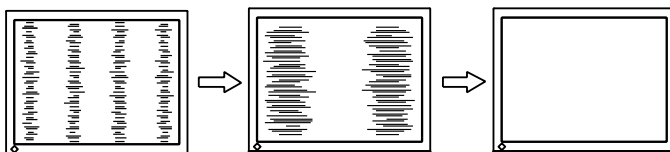

- **To remove flickering or blurring [Phase]**

Adjustable range: 0 to 63

- (1) Choose <Phase> from the <Screen> menu, and press .  
The <Phase> menu appears.
- (2) Adjust the phase with or , and press .  
The adjustment is completed.

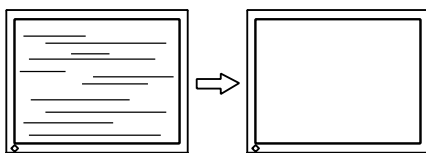







#### Note

- Press the control button slowly so as not to miss the adjustment point.
- When blurring, flickering or bars appear on the screen after adjustment, proceed to [Phase] to remove flickering or blurring.

#### Attention

- Flickering or blurring may not be eliminated depending on your PC or graphics board.

- **To correct screen position [Position]**

- (1) Choose <Position> from the <Screen> menu, and press .  
The <Position> menu appears.
- (2) Adjust the position with  /  /  /  to display the image properly in the display area of the monitor, and press .  
The adjustment is completed.

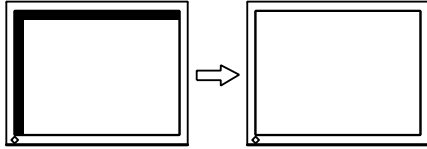





## 5 Adjust the color gradation.

- **To adjust color gradation automatically [Range]**

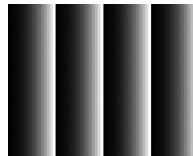
Every color gradation (0 to 255) can be displayed by adjusting the signal output level.

- (1) Display Pattern 2 in full screen on the monitor using the “Screen Adjustment Utility” or the screen adjustment pattern files.







- (2) Choose <Range> from the <Auto Adjustment> menu, and press .
- (3) Choose “Execute” with  or , and press .  
The output range is adjusted automatically.
- (4) Close the Pattern 2. When using the “Screen Adjustment Utility”, close the program.

## 6 Modify blurred characters or lines.

- **To modify blurred characters/lines [Smoothing]**

When a image is displayed with a resolution other than the recommendation, the characters or lines of the displayed image may be blurred.

Adjustable range: 1 to 5

- (1) Choose <Screen> from the Adjustment menu, and press .
- (2) Choose <Smoothing> from the <Screen> menu, and press .
- (3) Adjust the characters/lines with  or , and press .  
The adjustment is completed.

### Note

- Since the number of pixels and the pixel positions are fixed on the LCD monitor, only one position is provided to display images correctly. The position adjustment is made to shift an image to the correct position.
- When vertical bars appear on the screen after adjustment, go back to “To eliminate vertical bars [Clock]”.  
(Clock → Phase → Position)

### Attention

- Smoothing setting may not be required depending on the display resolution. (You cannot choose the smoothing icon.)

## 2-3 Color Adjustment

- **To select the display mode (FineContrast mode)**

FineContrast allows you to select the best display mode easily according to the monitor's application.

FineContrast mode

Mode	Purpose
Custom	Available to change all setting values.
sRGB	Suitable for color matching with sRGB compatible peripherals.
Text	Suitable for displaying texts for word processing or spreadsheets.
Picture	Suitable for displaying images such as photos or picture images.
Movie	Suitable for playing back animated images.

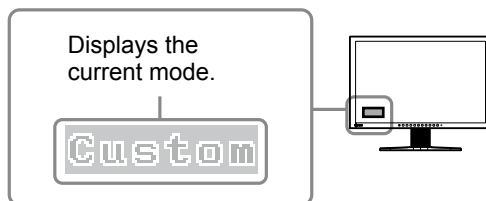

(1) Press **(M)**.

The FineContrast mode name appears at the lower left of the screen.

(2) One of five modes is displayed in turn each time **(M)** is pressed.

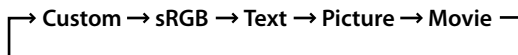

### Note

- The Adjustment menu and the FineContrast mode name cannot be displayed at the same time.
- “ScreenManager Pro for LCD” allows you to select the FineContrast mode automatically according to the application used. (Refer to “Chapter 3 Auto FineContrast” on the User’s Manual for “ScreenManager Pro for LCD”.)











## • To perform advanced adjustments

Independent setting and saving of color adjustment are available for each FineContrast mode.

## • Adjustment items in each mode

According to the FineContrast mode selected, the adjustable function differs.





√ : Adjustment available    – : Invalid for adjustment

Icon	Function	FineContrast mode				
		Custom	sRGB	Text	Picture	Movie
	Brightness	√	√	√	√	√
	Contrast	√	–	√	√	√
	Temperature	√	–	√	√	√
	Gamma	√	–	√	–	–
	Saturation	√	–	√	√	√
	Hue	√	–	√	√	√
	Gain	√	–	–	–	–
	Reset	√	√	√	√	√

## • To adjust the brightness [Brightness]

The screen brightness is adjusted by changing the brightness of the backlight (Light source from the LCD back panel).





Adjustable range: 0 to 100%

- Choose <Color> from the Adjustment menu, and press .
- Choose <Brightness> from the <Color> menu, and press .  
The <Brightness> adjustment menu appears.
- Adjust the brightness with  or , and press .  
The adjustment is completed.

## • To adjust the contrast [Contrast]

The luminance of the screen is adjusted by varying the video signal level.

Adjustable range: 0 to 100%

- Choose <Color> from the Adjustment menu, and press .
- Choose <Contrast> from the <Color> menu, and press .  
The <Contrast> adjustment menu appears.
- Adjust the contrast with  or , and press .  
The adjustment is completed.



### Attention

- Wait 30 minutes or more from monitor power on before starting the color adjustment.
- Perform the range adjustment first when adjusting color for analog input signals.  
(Refer to “To adjust color gradation automatically” on [page 13](#)).
- The same image may be seen in different colors on multiple monitors due to their monitor-specific characteristics. Make fine color adjustment visually when matching colors on multiple monitors.

### Note

- The values shown in “%” or “K” are available only as reference.
- Using the “ScreenManager Pro for LCD” allows you to perform the color adjustment by using the mouse and keyboard of your PC. The adjusted status can be registered as a color data and restore the data later. (Refer to “Chapter 4 Color Adjustment” on the User’s Manual for “ScreenManager Pro for LCD”.)

### Note

- You can also adjust the brightness by pressing  or  without displaying the adjustment menu.

### Note

- In the contrast of 50%, every color gradation is displayed.
- When adjusting the monitor, it is recommended to perform the brightness adjustment which may not lose the gradation characteristics, prior to the contrast adjustment. Perform the contrast adjustment in the following cases.
  - When you feel the image is bright even if the brightness is set to 0%.
  - When you feel the black level of the screen is bright (Set the brightness down and the contrast to higher than 50%).





## ● To adjust the color temperature [Temperature]

The color temperature can be adjusted. The color temperature is normally used to express the hue of “White” and/or “Black” by a numerical value. The value is expressed in degrees “K” (Kelvin).

In the same way as the flame temperature, the image on the monitor is displayed reddish if the color temperature is low and is bluish if the color temperature is high. The gain preset values are set for each color temperature setting value.

5000K	The white color image is displayed reddish. The 5000K or 6000K is usually used in the printing industry.
6500K	The white color image is displayed in warm white like paper white. The temperature is suitable to display photographs or video images.
9300K	The white color image is displayed slightly bluish white.





Adjustable range: Off, 4000K-10000K (specified by every 500K unit, including 9300K)

- (1) Choose <Color> from the Adjustment menu, and press .
- (2) Choose <Temperature> from the <Color> menu, and press .  
The <Temperature> adjustment menu appears.
- (3) Adjust the color temperature with  or , and press .  
The adjustment is completed.

## ● To adjust the gamma value [Gamma]

The gamma value can be adjusted. The luminance of the monitor varies depending on the input signal, however, the variation rate is not proportional to the input signal. To keep the balance between the input signal and the luminance of the monitor is called as “Gamma correction”.





Adjustable range: 1.8, 2.0, 2.2

- (1) Choose <Color> from the Adjustment menu, and press .
- (2) Choose <Gamma> from the <Color> menu, and press .  
The <Gamma> adjustment menu appears.
- (3) Adjust the gamma value with  or , and press .  
The adjustment is completed.

## ● To adjust the color saturation [Saturation]

This function allows you to adjust the saturation of the color on the monitor.

Adjustable range: -128 to 127

- (1) Choose <Color> from the Adjustment menu, and press .
- (2) Choose <Saturation> from the <Color> menu, and press .  
The <Saturation> adjustment menu appears.
- (3) Adjust the saturation of the color with  or , and press .  
The adjustment is completed.

### Note

- You cannot adjust the value if the icon is not displayed, depending on the FineContrast mode selected. (See “Adjustment items in each mode” on [page 15](#).)
- [Gain] allows you to perform more advanced adjustment (See “To adjust the gain value” on [page 17](#)).
- If you set to [Off], the image is displayed in the preset color of the monitor (Gain: 100% for each RGB).
- When changing the gain value, the color temperature adjusting range is changed to “Off”.

### Note

- You cannot adjust the value if the icon is not displayed, depending on the FineContrast mode selected. (See “Adjustment items in each mode” on [page 15](#).)

### Attention

- This function does not enable to display every color gradation.





### Note

- You cannot adjust the value if the icon is not displayed, depending on the FineContrast mode selected. (See “Adjustment items in each mode” on [page 15](#).)
- Setting the minimum (-128) turns the image to a monochrome screen.

### ● To adjust the hue [Hue]

This function allows you to adjust the hue. If you set the hue to a high value, the image turns greenish. If low, the image turns purplish.





Adjustable range: -32 to 32

- (1) Choose <Color> from the Adjustment menu, and press .
- (2) Choose <Hue> from the <Color> menu, and press .  
The <Hue> adjustment menu appears.
- (3) Adjust the hue with  or , and press .  
The adjustment is completed.

### ● To adjust the gain value [Gain]

Each luminance of red/green/blue composing the color is called “Gain”. The gain adjustment may change the color tone of the “White” (when the max input signal for each color is obtained)





Adjustable range: 0 to 100%

- (1) Choose <Color> from the Adjustment menu, and press .
- (2) Choose <Gain> from the <Color> menu, and press .  
The <Gain> adjustment menu appears.
- (3) Adjust the respective value of Red, Green or Blue with  or , and press .  
The adjustment is completed.

## 2-4 Adjusting Volume [Volume]





This function allows you to adjust volume up or down.

Adjustable range: 0 to 20

- (1) Choose <Sound> from the Adjustment menu, and press .
- (2) Choose <Volume> from the <Sound> menu, and press .  
The volume adjustment menu appears.
- (3) Adjust the volume with  or , and press .  
The adjustment is completed.

## 2-5 Turning off the audio output at Power Saving mode [Power Save]

This monitor allows you to turn off the audio output from the speakers/headphone at the power saving mode.

- (1) Choose <Sound> from the Adjustment menu, and press .
- (2) Choose <Power Save> from the <Sound> menu, and press .  
The <Power Save> setting menu appears.
- (3) Select “On” or “Off” with  or , and press .  
The setting is completed.

#### Attention

- This function does not enable to display every color gradation.

#### Note

- You cannot adjust the value if the icon is not displayed, depending on the FineContrast mode selected. (See “Adjustment items in each mode” on [page 15.](#))



#### Attention

- This function does not enable to display every color gradation.

#### Note

- You cannot adjust the value if the icon is not displayed, depending on the FineContrast mode selected. (See “Adjustment items in each mode” on [page 15.](#))
- The gain value may change depending on the value of the color temperature.
- When changing the gain value, the color temperature adjusting range is changed to “Off”.

#### Note

- You can also adjust volume by pressing  or  without displaying the adjustment menu.

## 2-6 Setting On/Off for the automatic brightness adjustment function [Auto EcoView]

The sensor on the front side of the monitor detects the environmental brightness to adjust the screen brightness automatically and comfortably by using the Auto EcoView function.

(1) Press .

The <Auto EcoView> setting menu appears.

(2) The On/Off setting is toggled by pressing .



## 2-7 Setting On/Off for Power Saving mode [Power Save]

This function allows you to set the monitor into the power saving mode according to the PC status.

(1) Choose <PowerManager> from the Adjustment menu, and press .

(2) Choose <Power Save> from the <PowerManager> menu, and press .

The <Power Save> setting menu appears.

(3) Select “On” or “Off” with  or , and press .

The setting is completed.

### ■ Analog input

This monitor complies with the VESA DPMS standard.

#### [Power Saving System]

PC		Monitor	Power Indicator
Operating		Operating	Blue
Power saving	STAND-BY SUSPENDED OFF	Power saving	Orange

### ■ Digital input

This monitor complies with the DVI DMPM standard.

#### [Power Saving System]

The monitor enters the power saving mode in five seconds in connection with the PC setting.

PC	Monitor	Power Indicator
Operating	Operating	Blue
Power saving	Power saving	Orange

#### Note

- Be careful not to block the sensor on the lower side of the monitor when using the Auto EcoView function.







#### Attention

- Turning off the main power switch or unplugging the power cord completely shuts off power supply to the monitor.
- Power consumption changes even when a sound input signal is detected.

## 2-8 Turning off the monitor automatically [Off Timer]

This function allows you to switch the setting to turn off the monitor automatically after a specified time has passed at the power saving mode.

Adjustable range: Disable, Enable (0, 1, 2, 3, 5, 10, 15, 20, 25, 30, 45 min, 1-5h)

- (1) Choose <PowerManager> from the Adjustment menu, and press .
  - (2) Choose <Off Timer> from the <PowerManager> menu, and press .  
The <Off Timer> setting menu appears.
  - (3) Select “Enable” or “Disable” with  or .
  - When selecting “Enable”, set a monitor Off time with  or .
  - (4) Press .
- The setting is completed.

## 2-9 Displaying the level of power saving by EcoView Index

This function allows you to display the power saving level by green indicator. The power saving ratio comes to high as the indicator level meter lights towards right.







- (1) Press .
- The EcoView Index menu appears.

## 2-10 Setting Adjustment Menu Display

- To update menu settings [Menu Size/Menu Position/Menu Off Timer/Translucent]









### Menu Size

Change the Adjustment menu size using the following procedure.

- (1) Choose <Others> from the Adjustment menu, and press .
  - (2) Choose <Menu Settings> from the <Others> menu, and press .
  - (3) Choose <Menu Size> from the <Menu Settings> menu, and press .
  - The <Menu Size> menu appears.
  - (4) Select “Normal” or “Enlarged” with  or , and press .
- The setting is completed.

### Menu Position

Adjust the menu position using the following procedure.

- (1) Choose <Others> from the Adjustment menu, and press .
  - (2) Choose <Menu Settings> from the <Others> menu, and press .
  - (3) Choose <Menu Position> from the <Menu Settings> menu, and press .
  - The <Menu Position> menu appears.
  - (4) Select a menu position with  /  /  / , and press .
- The setting is completed.









### Note

- EcoView Index appears when adjusting brightness or switching the FineContrast mode, etc. You can switch the on/off setting of displaying EcoView Index in <EcoView Index> menu from the <PowerManager> menu.

## Menu Off Timer







Set the menu display time using the following procedure.

Adjustment range: Disable, Enable (15, 30, 45, 60s)

- (1) Choose <Others> from the Adjustment menu, and press .
- (2) Choose <Menu Settings> from the <Others> menu, and press .
- (3) Choose <Menu Off Timer> from the <Menu Settings> menu, and press .  
The <Menu Off Timer> menu appears.
- (4) Select “Enable” or “Disable” with  or .  
When selecting “Enable”, choose a time for displaying menu with  or .
- (5) Press .  
The setting is completed.

## Translucent





Set the transparency for menu display using the following procedure.

- (1) Choose <Others> from the Adjustment menu, and press .
- (2) Choose <Menu Settings> from the <Others> menu, and press .
- (3) Choose <Translucent> from the <Menu Settings> menu, and press .  
The <Translucent> menu appears.
- (4) Adjust the transparency for menu display with  or , and press .  
The setting is completed.

## 2-11 Setting Orientation



### • To set the orientation of the Adjustment menu [Orientation]

This function allows you to change the orientation of the Adjustment menu when using the monitor screen in vertical display position.

- (1) Choose <Others> from the Adjustment menu, and press .
- (2) Choose <Orientation> from the Others menu, and press .  
The <Orientation> menu appears.
- (3) Select “Landscape” or “Portrait” with  or , and press .  
The setting is completed.
- (4) When selecting “Portrait”, turn the monitor screen 90° in clockwise direction.

## 2-12 Locking Buttons

This function allows you to lock  to prevent changing the adjusted/set status.

- (1) Press  to turn off the monitor.
- (2) Press  holding  down to turn on the monitor.  
The Lock/Unlock setting is toggled by performing the operation in step 2.

### Note

- The display time of the FineContrast mode and EcoView Index remains unchanged.

### Note

- If you use the monitor with “Portrait” position, the setting may be required to change depending on the graphics board used in your PC. Refer to the manual of the graphics board for details..



## 2-13 Displaying Monitor Information [Information]

This function allows you to display the input signal status, current resolution and model name.

Information 1/3 : Input signal status (analog/digital), resolution and H/V frequency



Information 2/3 : Enable/Disable setting for DDC/CI

Information 3/3 : Model name, serial number and usage time

- (1) Choose <Information> from the Adjustment menu, and press .  
The <Information> menu appears.
- (2) Then, press  to check settings, etc.





## 2-14 Enabling/Disabling DDC/CI communication [DDC/CI]

This function allows you to enable/disable the DDC/CI communication.

- (1) Press  to turn off the monitor.
- (2) Press  holding  down to turn on the monitor.  
The Enable/Disable setting is toggled by performing the operation in step 2.

## 2-15 Setting Power Indicator ON/OFF [Power Indicator]

This function allows you to set the power indicator (blue) ON/OFF in the monitor ON condition.







- (1) Choose <Others> from the Adjustment menu, and press .
- (2) Choose <Power Indicator> from the <Others> menu, and press .  
The <Power Indicator> menu appears.
- (3) Select "Enable" or "Disable" with  or , and press .  
The setting is completed.

## 2-16 Setting Language [Language]

This function allows you to select a language for the adjustment menu or displaying message.

### Selectable languages

English/German/French/Spanish/Italian/Swedish/Simplified Chinese/  
Traditional Chinese/Japanese

- (1) Choose <Language> menu from the Adjustment menu, and press .  
The <Language> menu appears.
- (2) Choose a language with  /  /  / , and press .  
The setting is completed.

### Note



- The usage time is not always "0" when you purchase the monitor due to factory inspection.

### Note

- You can check the DDC/CI setting in the <Information> menu.

## 2-17 Setting EIZO logo display ON/OFF

The EIZO logo appears on the display when turning on the monitor. This function allows you to display, or not, the EIZO logo.





- (1) Press  to turn off the monitor.
- (2) Press  holding  down to turn on the monitor.  
The EIZO logo display setting is toggled by performing the operation in step 2.

## 2-18 Resuming the Default Setting [Reset]

There are two types of Reset. One is to reset the color adjustment only to the default settings, and the other is to reset all the settings to the default settings.





### • To reset color adjustment values

Only the adjustment values in the current FineContrast mode will revert to the default settings (factory settings).

- (1) Choose <Color> from the Adjustment menu, and press .
- (2) Choose <Reset> from the <Color> menu and press .  
The <Reset> menu appears.
- (3) Select <Reset> with  or , and press .  
The color adjustment values revert to the default settings.

### • To reset all adjustments to the factory default settings

Reset all adjustments to the factory default settings.

- (1) Choose <Others> from the Adjustment menu, and press .
- (2) Choose <Reset> from the <Others> menu, and press .  
The <Reset> menu appears.
- (3) Select <Reset> with  or , and press .  
All setting values revert to the default settings.

#### Attention

- After resetting, you cannot undo the operation.

#### Note

- For main default settings, refer to “Main default settings (factory settings)” on [page 29](#).



# Chapter 3 Connecting Cables

## 3-1 Connecting Two PCs to the Monitor

Two PCs can be connected to the monitor through the DVI-D and the D-Sub mini 15 pin connector on the back of the monitor.

### Connection examples

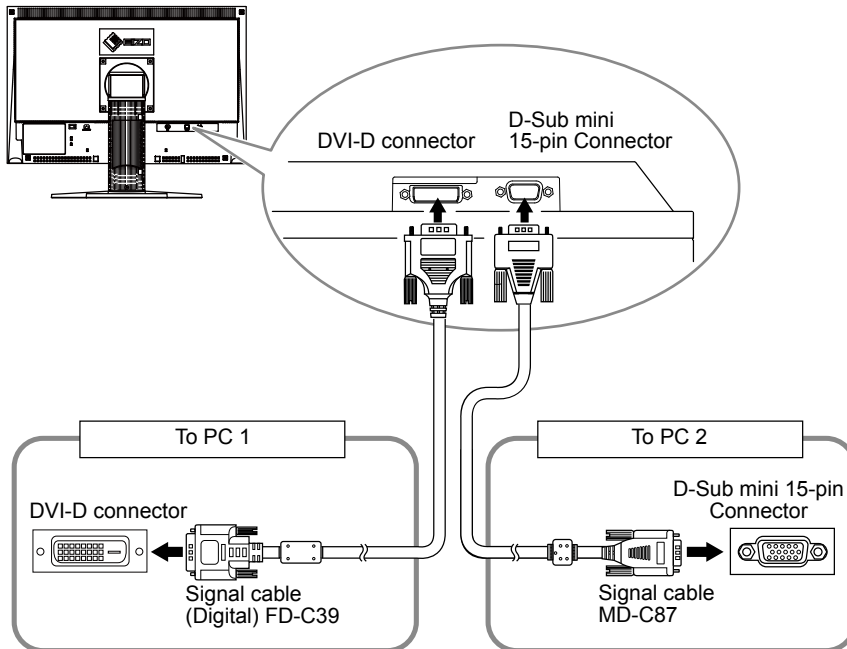

- **To switch the input signal**

The input signal switches each time **S** is pressed.

When the signal is switched, the active input port name appears at the top right corner of the screen.

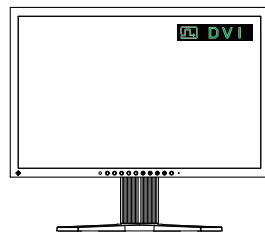

### • To set input signal selection [Input Signal]

The monitor recognizes the connector through which PC signals are input. When either PC is turned off or enters the power-saving mode, the monitor automatically displays signals of another PC.

Priority setting	Function
Auto	When either PC is turned off or enters the power-saving mode, the monitor automatically displays signals of another PC.
Manual	The monitor detects only the PC's signals currently displaying automatically. Select an active input signal with <b>(S)</b> .

#### [Input signal setting]

- (1) Choose <Others> from the Adjustment menu, and press **(M)**.
- (2) Choose <Input Signal> from the <Others> menu, and press **(M)**.  
The <Input Signal> menu appears.
- (3) Select "Auto" or "Manual" with **(▲)** or **(▼)**, and press **(M)**.  
The setting is completed.

## 3-2 Adjusting the DVI Input Level [DVI Input Level]

This function allows you to adjust the DVI signal input level when using a DVI long cable.

Adjustment range: Auto, Manual (1 to 8)

- (1) Press **(P)** to turn off the monitor.
- (2) Press **(P)** holding **(H)** down to turn on the monitor.  
The <DVI Input Level> adjustment menu appears.
- (3) Select "Auto" or "Manual" with **(▲)** or **(▼)**.  
When selecting "Manual", adjust the input level with **(◀)** or **(▶)** to display correctly.
- (4) Press **(M)**.  
The adjustment is completed.



#### Note





- When "Auto" is selected for <Input Signal>, the monitor's power-saving function works only when the two PCs are in the power-saving mode.

# Chapter 4 Troubleshooting

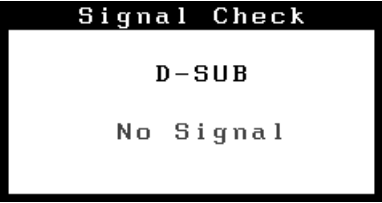
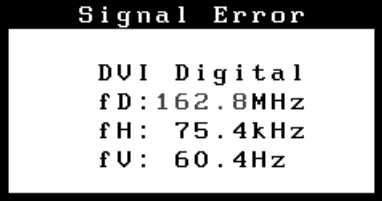
If a problem still remains after applying the suggested remedies, contact your local dealer.

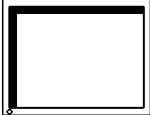
- No-picture problems → See No.1 - No.2.
- Imaging problems (digital input) → See No.3 - No.8.
- Imaging problems (analog input) → See No.3 - No.12.
- Other problems → See No.13 - No.17.

Problems	Possible cause and remedy
<p><b>1. No picture</b></p> <ul style="list-style-type: none"> <li>• Power indicator does not light.</li> </ul>	<ul style="list-style-type: none"> <li>• Check whether the power cord is connected correctly. If the problem persists, turn off the monitor, and then turn it on again a few minutes later.</li> <li>• Turn the main power switch on.</li> <li>• Press .</li> </ul>
<ul style="list-style-type: none"> <li>• Power indicator is lighting blue.</li> </ul>	<ul style="list-style-type: none"> <li>• Set each adjusting value in [Brightness], [Contrast] or RGB of [Gain] to higher level. (see <a href="#">page 17</a>)</li> <li>• When using the long DVI cable, adjust the DVI input level using [DVI Input Level]. (see <a href="#">page 24</a>)</li> </ul>
<ul style="list-style-type: none"> <li>• Power indicator is lighting orange.</li> </ul>	<ul style="list-style-type: none"> <li>• Switch the input signal with .</li> <li>• Operate the mouse or keyboard.</li> <li>• Check whether the PC is turned on.</li> </ul>
<p><b>2. The message below appears.</b></p> <ul style="list-style-type: none"> <li>• This message appears when no signal is input.</li> </ul>	<p>This message appears when the signal is not input correctly even when the monitor functions properly.</p> <ul style="list-style-type: none"> <li>• The message shown left may appear, because some PCs do not output the signal soon after power-on.</li> <li>• Check whether the PC is turned on.</li> <li>• Check whether the signal cable is connected properly.</li> <li>• Switch the input signal with .</li> <li>• When using the long DVI cable, adjust the DVI input level using [DVI Input Level]. (see <a href="#">page 24</a>)</li> </ul>
 <p style="text-align: center;">Signal Check</p> <p style="text-align: center;">D-SUB</p> <p style="text-align: center;">No Signal</p>	
<ul style="list-style-type: none"> <li>• The message shows that the input signal is out of the specified frequency range. (Such signal frequency is displayed in red.)</li> </ul> <p>Example:</p>	<ul style="list-style-type: none"> <li>• Check whether the signal setting of your PC matches the resolution and the vertical frequency settings for the monitor. (see <a href="#">page 6</a>)</li> <li>• Reboot the PC.</li> <li>• Select an appropriate display mode using the graphics board's utility. Refer to the manual of the graphics board for details.</li> </ul>
 <p style="text-align: center;">Signal Error</p> <p style="text-align: center;">DVI Digital</p> <p style="text-align: center;">fD: 162.8MHz</p> <p style="text-align: center;">fH: 75.4kHz</p> <p style="text-align: center;">fV: 60.4Hz</p>	<p>fD : Dot Clock (Displayed only when the digital signal inputs)</p> <p>fH : Horizontal Frequency</p> <p>fV : Vertical Frequency</p>
<p><b>3. The screen is too bright or too dark.</b></p>	<ul style="list-style-type: none"> <li>• Adjust using [Brightness] or [Contrast]. (The LCD monitor backlight has a fixed life span. When the screen becomes dark or begins to flicker, contact your local dealer.)</li> <li>• Turn on the Auto EcoView function. The monitor detects the environmental brightness to adjust the screen brightness automatically.</li> </ul>
<p><b>4. Characters are blurred.</b></p>	<ul style="list-style-type: none"> <li>• Check whether the signal setting of your PC matches the resolution and the vertical frequency settings for the monitor. (see <a href="#">page 6</a>)</li> <li>• Adjust using [Smoothing]. (see <a href="#">page 13</a>)</li> </ul>
<p><b>5. Afterimages appear.</b></p>	<ul style="list-style-type: none"> <li>• Use a screen saver or off timer function for a long-time image display.</li> <li>• Afterimages are particular to LCD monitors. Avoid displaying the same image for a long time.</li> </ul>

Problems	Possible cause and remedy
6. Green/red/blue/white dots or defective dots remain on the screen.	<ul style="list-style-type: none"> <li>This is due to LCD panel characteristics and is not a failure.</li> </ul>
7. Interference patterns or pressure marks remain on the screen.	<ul style="list-style-type: none"> <li>Leave the monitor with a white or black screen. The symptom may disappear.</li> </ul>
8. Noise appears on the screen.	<ul style="list-style-type: none"> <li>When entering the signals of analog input, change the setting to "On" in &lt;Signal Filter&gt; from the &lt;Screen&gt; menu.</li> <li>When entering the signals of HDCP system, the normal images may not be displayed immediately.</li> <li>When using the long DVI cable, adjust the DVI input level using [DVI Input Level]. (see <a href="#">page 24</a>)</li> </ul>
9. Display position is incorrect. 	<ul style="list-style-type: none"> <li>Adjust image position so that it is displayed properly within the display area using [Position]. (see <a href="#">page 13</a>)</li> <li>If the problem persists, use the graphics board's utility if available to change the display position.</li> </ul>
10. Vertical bars appear on the screen or a part of the image is flickering. 	<ul style="list-style-type: none"> <li>Adjust using [Clock]. (see <a href="#">page 12</a>)</li> </ul>
11. Whole screen is flickering or blurring. 	<ul style="list-style-type: none"> <li>Adjust using [Phase]. (see <a href="#">page 12</a>)</li> </ul>
12. Upper part of the screen is distorted as shown below. 	<ul style="list-style-type: none"> <li>This is caused when both composite sync (X-OR) signal and separate vertical sync signal are input simultaneously. Select either composite signal or separate signal.</li> </ul>
13. The <Smoothing> icon on the Adjustment menu <Screen> cannot be selected.	<ul style="list-style-type: none"> <li>Smoothing setting may not be required depending on the display resolution. (You cannot choose the smoothing icon.)</li> <li>&lt;Smoothing&gt; is disabled when the screen is displayed in the following resolutions. <ul style="list-style-type: none"> <li>1680 × 1050</li> </ul> </li> </ul>
14. The adjustment menu does not appear.	<ul style="list-style-type: none"> <li>Check whether the operation lock function works. (see <a href="#">page 20</a>)</li> </ul>
15. The FineContrast mode is not displayed.	<ul style="list-style-type: none"> <li>Check whether the Main menu of Adjustment menu is displayed. (Refer to "To perform advanced adjustments" on <a href="#">page 15</a>.)</li> </ul>
16. The auto adjust function does not work correctly.	<ul style="list-style-type: none"> <li>This function does not work when digital signal is input.</li> <li>Check whether the operation lock function works. (see <a href="#">page 20</a>)</li> <li>This function does not work correctly with some graphics boards.</li> </ul>
17. No audio output.	<ul style="list-style-type: none"> <li>Check whether the mini jack cable is correctly connected.</li> <li>Check whether volume is set to 0.</li> <li>Check the setting of the PC and the audio playback software.</li> </ul>

# Chapter 5 Reference

## 5-1 Attaching an Arm

The stand can be removed and replaced with an arm (or another stand) to be attached to the monitor. Use an arm or stand of EIZO option.

### [Attaching]

**1 Lay the LCD monitor on a soft cloth spread over on a stable surface with the panel surface facing down.**

**2 Remove the stand. (Prepare a screwdriver.)**

Unscrew the four screws securing the unit and the stand with the screwdriver.

**3 Attach the monitor to the arm or stand.**

Secure the monitor to the arm or stand using the screws specified in the user's manual of the arm or stand.

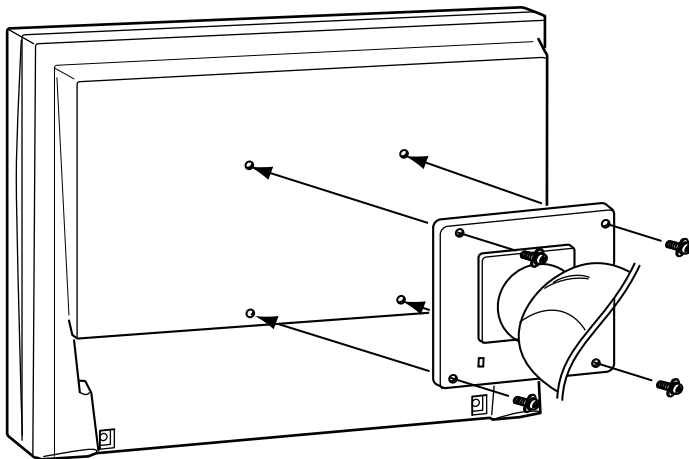

### Attention

- When attaching an arm or stand, follow the instructions of their user's manual.
- When using another manufacturer's arm or stand, confirm the following in advance and select one conforming to the VESA standard. Use M4 × 12 mm screws supplied with the monitor.
  - Clearance between the screw holes: 100 mm × 100 mm
  - Thickness of plate: 2.6 mm
  - Strong enough to support weight of the monitor unit (except the stand) and attachments such as cables.
- When using an arm or stand, attach it to meet the following tilt angles of the monitor.
  - Up 45 degrees, down 45 degrees (horizontal display, and vertical display rotated 90 degrees clockwise)
- Connect the cables after attaching an arm.

## 5-2 Specifications

LCD Panel		22-inch (560 mm) TFT color LCD with anti-glare Viewing angle: Horizontal 170°, Vertical 160° (CR:10 or more)
Dot Pitch		0.282mm
Horizontal Scan Frequency		Analog: 31-82kHz Digital: 31-65kHz
Vertical Scan Frequency		Analog: 55-76Hz (Non-interlace) (1680 × 1050: 55-61Hz) Digital: 59-61Hz (Non-interlace) (VGA TEXT: 69-71Hz)
Resolution		1680 dots × 1050 lines
Max. Dot Clock		Analog: 150MHz Digital: 120MHz
Max. Display Color		Approx. 16.77 million colors: Applicable to 8 bit (1064.33 million colors/ 10bit LUT)
Display Area (H × V)		473.8mm × 296.1mm
Power Supply		100-120 VAC ±10%, 50/60Hz 0.85A 200-240 VAC ±10%, 50/60Hz 0.5A
Power Consumption	Screen Display On	51W or less (Speaker working) 47W or less (Speaker not working)
	Power saving mode	0.7W or less (for single signal input, when stereo mini jack cable is not connected)
	Power button Off	0.5W or less (when stereo mini jack cable is not connected)
	Main Power switch Off	0W
Input Signal Connector		DVI-D connector (Applicable to HDCP), D-Sub mini 15-pin
Analog Input Signal (Sync)		Separate, TTL, positive/ negative Composite, TTL, positive/ negative
Analog Input Signal (Video)		Analog, Positive (0.7Vp-p/75Ω)
Digital Signal Transmission System		TMDS (Single Link)
Video Signal Memory		Analog signal: 45 (preset: 17) Digital signal: 10
Audio Output		Speaker output: 0.5W + 0.5W (8Ω, THD: 10% or less) Headphone output: 2mW + 2mW
Line input		Input impedance : 48 kΩ (typ.) Input level : 1.0 Vrms (Max.)
Plug & Play		VESA DDC 2B / EDID structure 1.3
Dimensions (Width) × (Height) × (Depth)	Main unit (including Height adjustable stand)	507 mm (20.0 inch) × 406 - 506 mm (16.0 - 19.9 inch) × 205 mm (8.1 inch)
	Main unit (including Tilt stand)	507 mm (20.0 inch) × 415 mm (16.3 inch) × 205 mm (8.1 inch)
	Main unit (including EZ-UP stand)	507 mm (20.0 inch) × 351.5 - 516.5 mm (13.8 - 20.3 inch) × 279.9 mm - 296.4 mm (11.0 - 11.7 inch)
	Main unit (without stand)	507 mm (20.0 inch) × 333 mm (13.1 inch) × 74 mm (2.9 inch)

Mass	Main unit (including Height adjustable stand)	Approx. 7.7 kg (17.0 lbs.)
	Main unit (including Tilt stand)	Approx. 6.8 kg (15.0 lbs.)
	Main unit (including EZ-UP stand)	Approx. 10.6 kg (23.4 lbs.)
	Main unit (without stand)	Approx. 5.8 kg (12.8 lbs.)
Movable range	Height adjustable stand	Tilt: 30° Up, 0° Down Swivel: 35° Right, 35° Left Adjustable height: 100 mm (3.9 inch) Rotation: 90° (clockwise)
	Tilt stand	Tilt: 30° Up, -5° Down
	EZ-UP stand	Tilt: 25° Up, 0° Down Swivel: 172° Right, 172° Left Adjustable height: 165 mm (6.5 inch) Rotation: 90° (clockwise)
Environmental Conditions	Temperature	Operating temperature: 5 °C - 35 °C (41 °F - 95 °F) Storage temperature: -20 °C - 60 °C (-4 °F - 140 °F)
	Humidity	Operating humidity: 30% - 80% R.H. (no condensation) Storage humidity: 30% - 80% R.H. (no condensation)
	Pressure	Operating: 700 to 1,060 hPa Storage: 200 to 1,060 hPa

#### Main default settings (factory settings)

Auto EcoView	On	
Smoothing	3	
FineContrast Mode	Custom	
PowerManager	On	
Input Signal	Auto	
Off Timer	Disable	
Menu Settings	Menu Size	Normal
	Menu Off Timer	45 sec
Language	English	

### Outside Dimensions (Height adjustable stand)

unit : mm (inch)

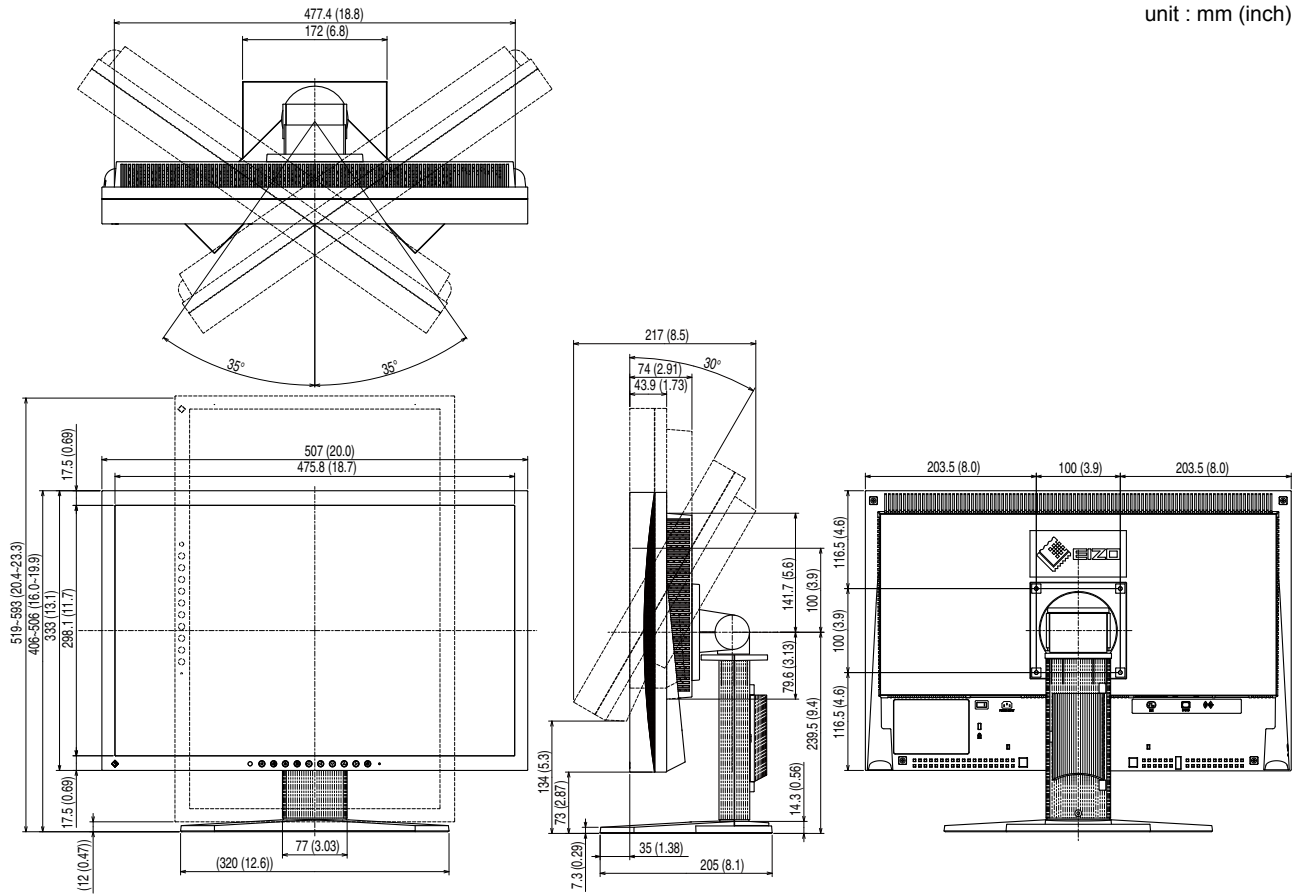

### Outside Dimensions (Tilt stand)

unit : mm (inch)

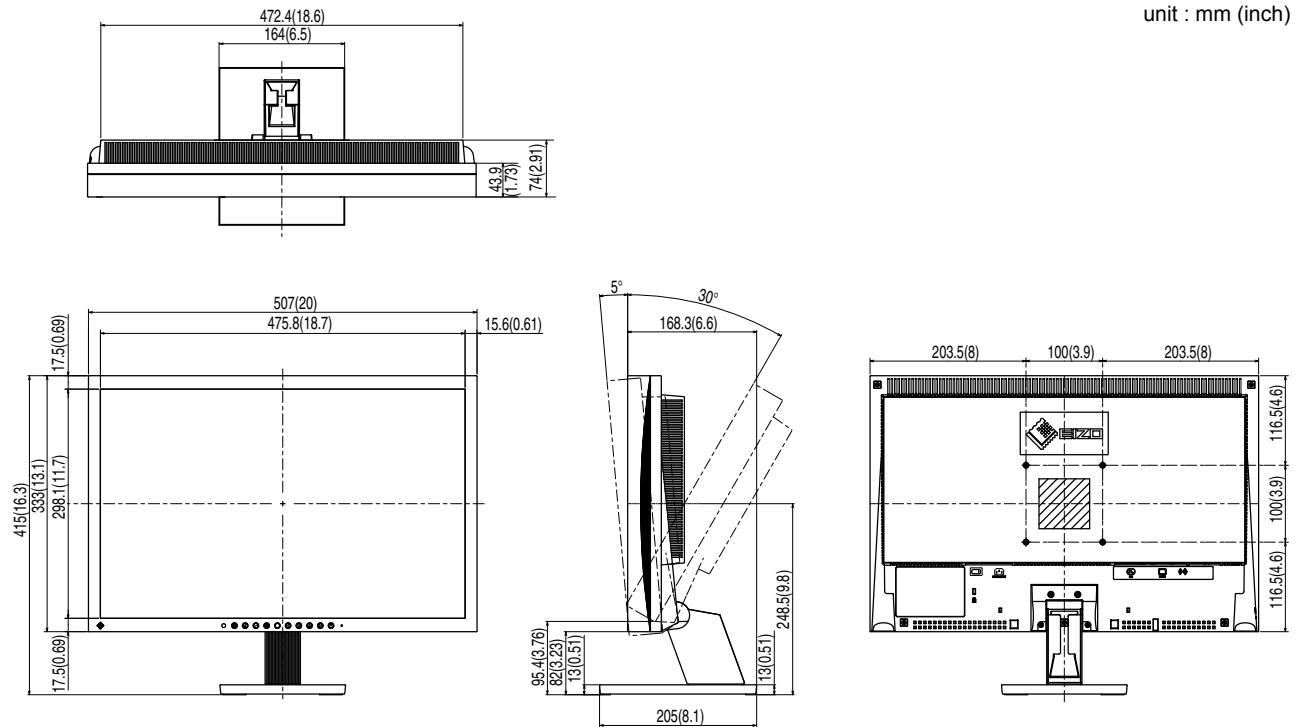



# Outside Dimensions (EZ-UP stand)

unit : mm (inch)

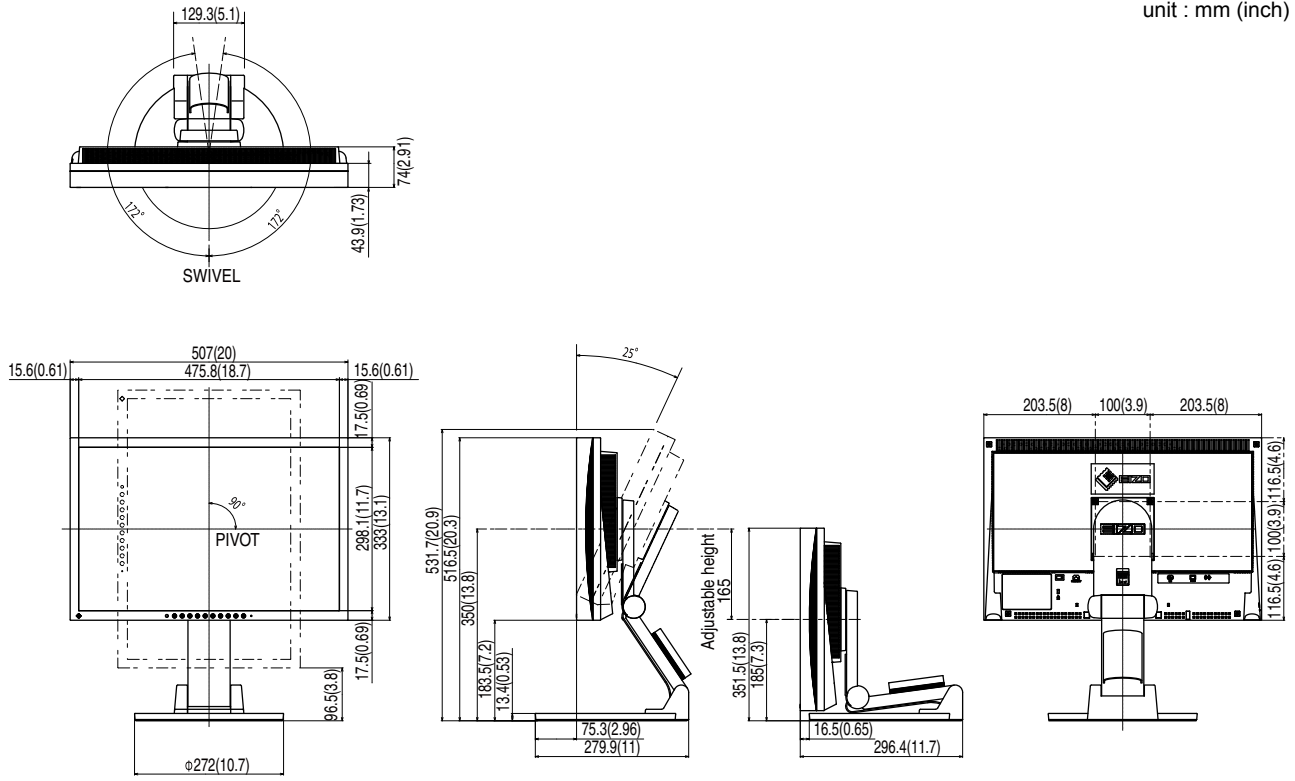

## Connector Pin Assignment

- DVI-D connector

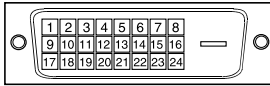

Pin No.	Signal	Pin No.	Signal	Pin No.	Signal
1	T.M.D.S. Data 2-	9	T.M.D.S. Data1-	17	T.M.D.S. Data0-
2	T.M.D.S. Data 2+	10	T.M.D.S. Data1+	18	T.M.D.S. Data0+
3	T.M.D.S. Data2/4 Shield	11	T.M.D.S. Data1/3 Shield	19	T.M.D.S. Data0/5 Shield
4	NC*	12	NC*	20	NC*
5	NC*	13	NC*	21	NC*
6	DDC Clock (SCL)	14	+5V Power	22	T.M.D.S. Clock shield
7	DDC Data (SDA)	15	Ground (return for +5V, Hsync, and Vsync)	23	T.M.D.S. Clock+
8	NC*	16	Hot Plug Detect	24	T.M.D.S. Clock-

(NC\*: No Connection)

- D-Sub mini 15-pin connector

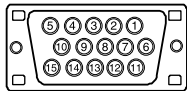

Pin No.	Signal	Pin No.	Signal	Pin No.	Signal
1	Red video	6	Red video ground	11	NC*
2	Green video	7	Green video ground	12	Data (SDA)
3	Blue video	8	Blue video ground	13	H. Sync
4	NC*	9	NC*	14	V. Sync
5	Ground	10	Ground	15	Clock (SCL)

(NC\*: No Connection)

## Accessories List

Cleaning Kit	EIZO ScreenCleaner
Speaker Unit	i•Sound L3*

\* May not allowed to attach the option speaker depending on the stand type.

For the latest information about the accessories, refer to our web site.

<http://www.eizo.com>

## 5-3 Glossary

### Clock

The analog input monitor needs to reproduce a clock of the same frequency as the dot clock of the graphics system in use, when the analog input signal is converted to a digital signal for image display.

This is called clock adjustment. If the clock pulse is not set correctly, some vertical bars appear on the screen.

### DDC/CI (Display Data Channel/Command Interface)

VESA provides the standardization for the interactive communication of the setting information, etc. between a PC and the monitor.

### DVI (Digital Visual Interface)

DVI is a digital interface standard. DVI allows direct transmission of the PC's digital data without loss.

This adopts the TMDS transmission system and DVI connectors. There are two types of DVI connectors. One is a DVI-D connector for digital signal input only. The other is a DVI-I connector for both digital and analog signal inputs.

### DVI DMPM (DVI Digital Monitor Power Management)

DVI DMPM is a digital interface power-saving function. The "Monitor ON (operating mode)" and "Active Off (power-saving mode)" are indispensable for DVI DMPM as the monitor's power mode.

### Gain

This is used to adjust each color parameter for red, green and blue. An LCD monitor displays the color by the light passing through the panel color filter. Red, green and blue are the three primary colors. All the colors on the screen are displayed by combining these three colors. The color tone can be changed by adjusting the light intensity (volume) passing through each color's filter.

### Gamma

Generally, the monitor brightness varies nonlinearly with the input signal level, which is called "Gamma Characteristic". A small gamma value produces a low-contrast image, while a large gamma value produces a high-contrast image.

### HDCP (High-bandwidth Digital Contents Protection)

Digital signal coding system developed to copy-protect the digital contents, such as video, music, etc. This helps to transmit the digital contents safely by coding the digital contents sent via DVI terminal on the output side and decoding them on the input side.

Any digital contents cannot be reproduced if both of the equipments on the output and input sides are not applicable to HDCP system.

### Phase

Phase means the sampling timing to convert the analog input signal to a digital signal. Phase adjustment is made to adjust the timing. It is recommended that phase adjustment be made after the clock is adjusted correctly.

### Range Adjustment

Range adjustment controls the signal output levels to display every color gradation. It is recommended that range adjustment be made before color adjustment.

### Resolution

The LCD panel consists of numerous pixels of specified size, which are illuminated to form images. This monitor consists of 1680 horizontal pixels and 1050 vertical pixels. At a resolution of 1680 x 1050, all pixels are illuminated as a full screen (1:1).

**sRGB (Standard RGB)**

International standard for “color reproduction and color space” among peripheral devices (such as monitors, printers, digital cameras, scanners). sRGB allows Internet users to closely match colors as a simple color matching means for the Internet use.

**Temperature**

Color temperature is a method to measure the white color tone, generally indicated in degrees Kelvin. The screen becomes reddish at a low temperature, and bluish at a high temperature, like the flame temperature.

5000K: Slightly reddish white

6500K: Warm white like paper white

9300K: Slightly bluish white

**TMDs (Transition Minimized Differential Signaling)**

A signal transmission system for digital interface.

**VESA DPMS (Video Electronics Standards Association - Display Power Management Signaling)**

VESA provides the standardization of signals from PC (graphics board) for power saving of PC monitors. DPMS defines the signal status between PC and monitor.

## 5-4 Preset Timing

The following table shows factory preset video timing (for analog signal only).

Mode	Dot clock		Frequency	Polarity
			Horizontal: kHz Vertical: Hz	
VGA 640×480@60Hz	25.2 MHz	Horizontal	31.47	Negative
		Vertical	59.94	Negative
VGA TEXT 720×400@70Hz	28.3 MHz	Horizontal	31.47	Negative
		Vertical	70.09	Positive
VESA 640×480@72Hz	31.5 MHz	Horizontal	37.86	Negative
		Vertical	72.81	Negative
VESA 640×480@75Hz	31.5 MHz	Horizontal	37.50	Negative
		Vertical	75.00	Negative
VESA 800×600@56Hz	36.0 MHz	Horizontal	35.16	Positive
		Vertical	56.25	Positive
VESA 800×600@60Hz	40.0 MHz	Horizontal	37.88	Positive
		Vertical	60.32	Positive
VESA 800×600@72Hz	50.0 MHz	Horizontal	48.08	Positive
		Vertical	72.19	Positive
VESA 800×600@75Hz	49.5 MHz	Horizontal	46.88	Positive
		Vertical	75.00	Positive
VESA 1024×768@60Hz	65.0 MHz	Horizontal	48.36	Negative
		Vertical	60.00	Negative
VESA 1024×768@70Hz	75.0 MHz	Horizontal	56.48	Negative
		Vertical	70.07	Negative
VESA 1024×768@75Hz	78.8 MHz	Horizontal	60.02	Positive
		Vertical	75.03	Positive
VESA 1152×864@75Hz	108.0 MHz	Horizontal	67.50	Positive
		Vertical	75.00	Positive
VESA 1280×960@60Hz	108.0 MHz	Horizontal	60.00	Positive
		Vertical	60.00	Positive
VESA 1280×1024@60Hz	108.0 MHz	Horizontal	63.98	Positive
		Vertical	60.02	Positive
VESA 1280×1024@75Hz	135.0 MHz	Horizontal	79.98	Positive
		Vertical	75.03	Positive
VESA CVT 1680×1050@60Hz	146.3 MHz	Horizontal	65.29	Negative
		Vertical	59.95	Positive
VESA CVT RB 1680×1050@60Hz	119.0 MHz	Horizontal	64.67	Positive
		Vertical	59.88	Negative

### Attention

- Display position may be deviated depending on the PC connected, which may require screen adjustment using Adjustment menu.
- If a signal other than those listed in the table is input, adjust the screen using the Adjustment menu. However, screen display may still be incorrect even after the adjustment.
- When interlace signals are used, the screen cannot be displayed correctly even after screen adjustment using the Adjustment menu.

For U.S.A. , Canada, etc. (rated 100-120 Vac) Only

## FCC Declaration of Conformity

**We, the Responsible Party**

EIZO NANAOTECHNOLOGIES INC.

5710 Warland Drive, Cypress, CA 90630

Phone: (562) 431-5011

**declare that the product**

Trade name: EIZO

Model: FlexScan S2202W

**is in conformity with Part 15 of the FCC Rules. Operation of this product is subject to the following two conditions: (1) this device may not cause harmful interference, and (2) this device must accept any interference received, including interference that may cause undesired operation.**

This equipment has been tested and found to comply with the limits for a Class B digital device, pursuant to Part 15 of the FCC Rules. These limits are designed to provide reasonable protection against harmful interference in a residential installation. This equipment generates, uses, and can radiate radio frequency energy and, if not installed and used in accordance with the instructions, may cause harmful interference to radio communications. However, there is no guarantee that interference will not occur in a particular installation. If this equipment does cause harmful interference to radio or television reception, which can be determined by turning the equipment off and on, the user is encouraged to try to correct the interference by one or more of the following measures.

- \* Reorient or relocate the receiving antenna.
- \* Increase the separation between the equipment and receiver.
- \* Connect the equipment into an outlet on a circuit different from that to which the receiver is connected.
- \* Consult the dealer or an experienced radio/TV technician for help.

Changes or modifications not expressly approved by the party responsible for compliance could void the user's authority to operate the equipment.

### Note

Use the attached specified cable below or EIZO signal cable with this monitor so as to keep interference within the limits of a Class B digital device.

- AC Cord
- Shielded Signal Cable (enclosed)

## Canadian Notice

This Class B digital apparatus complies with Canadian ICES-003.

Cet appareil numérique de la classe B est conforme à la norme NMB-003 du Canada.

### **Hinweise zur Auswahl des richtigen Schwenkarms für Ihren Monitor**

Dieser Monitor ist für Bildschirmarbeitsplätze vorgesehen. Wenn nicht der zum Standardzubehör gehörige Schwenkarm verwendet wird, muss statt dessen ein geeigneter anderer Schwenkarm installiert werden. Bei der Auswahl des Schwenkarms sind die nachstehenden Hinweise zu berücksichtigen:

Der Standfuß muß den nachfolgenden Anforderungen entsprechen:

- a) Der Standfuß muß eine ausreichende mechanische Stabilität zur Aufnahme des Gewichtes vom Bildschirmgerät und des spezifizierten Zubehörs besitzen. Das Gewicht des Bildschirmgerätes und des Zubehörs sind in der zugehörigen Bedienungsanleitung angegeben.
- b) Die Befestigung des Standfusses muß derart erfolgen, daß die oberste Zeile der Bildschirmanzeige nicht höher als die Augenhöhe eines Benutzers in sitzender Position ist.
- c) Im Fall eines stehenden Benutzers muß die Befestigung des Bildschirmgerätes derart erfolgen, daß die Höhe der Bildschirmmitte über dem Boden zwischen 135 – 150 cm beträgt.
- d) Der Standfuß muß die Möglichkeit zur Neigung des Bildschirmgerätes besitzen (max. vorwärts: 5°, min. nach hinten  $\geq 5^\circ$ ).
- e) Der Standfuß muß die Möglichkeit zur Drehung des Bildschirmgerätes besitzen (max.  $\pm 180^\circ$ ). Der maximale Kraftaufwand dafür muß weniger als 100 N betragen.
- f) Der Standfuß muß in der Stellung verharren, in die er manuell bewegt wurde.
- g) Der Glanzgrad des Standfusses muß weniger als 20 Glanzeinheiten betragen (seidenmatt).
- h) Der Standfuß mit Bildschirmgerät muß bei einer Neigung von bis zu 10° aus der normalen aufrechten Position kippstabil sein.

### **Hinweis zur Ergonomie :**

Dieser Monitor erfüllt die Anforderungen an die Ergonomie nach EK1-ITB2000 mit dem Videosignal, 1680 × 1050, Digital Eingang und mindestens 60,0 Hz Bildwiederholfrequenz, non interlaced. Weiterhin wird aus ergonomischen Gründen empfohlen, die Grundfarbe Blau nicht auf dunklem Untergrund zu verwenden (schlechte Erkennbarkeit, Augenbelastung bei zu geringem Zeichenkontrast.)

Übermäßiger Schalldruck von Ohrhörern bzw. Kopfhörern kann einen Hörverlust bewirken.

Eine Einstellung des Equalizers auf Maximalwerte erhöht die Ausgangsspannung am Ohrhörer- bzw. Kopfhörerausgang und damit auch den Schalldruckpegel.

„Maschinenlärminformations-Verordnung 3. GPSGV:

Der höchste Schalldruckpegel beträgt 70 dB(A) oder weniger gemäss EN ISO 7779“

[Begrenzung des maximalen Schalldruckpegels am Ohr]

Bildschirmgeräte: Größte Ausgangsspannung 150 mV

## 关于电子信息产品污染控制标识



本标识根据「电子信息产品污染控制管理办法」，适用于在中华人民共和国销售的电子信息产品。标识中央的数字为环保使用期限的年数。只要您遵守该产品相关的安全及使用注意事项，在自制造日起算的年限内，不会产生对环境污染或人体及财产的影响。上述标识粘贴在机器背面。

### • 有毒有害物质或元素的名称及含量

部件名称	有毒有害物质或元素					
	铅 (Pb)	汞 (Hg)	镉 (Cd)	六价铬 (Cr (VI))	多溴联苯 (PBB)	多溴二苯醚 (PBDE)
印刷电路板	×	○	○	○	○	○
机箱	○	○	○	○	○	○
液晶显示器	×	×	○	○	○	○
其他	×	○	○	○	○	○

○：表示该有毒有害物质在该部件所有均质材料中的含量均在 SJ/T 11363-2006 规定的限量要求以下。  
 ×：表示该有毒有害物质至少在该部件的某一均质材料中的含量超出 SJ/T 11363-2006 规定的限量要求。  
 （企业可在此处，根据实际情况对上表中打“×”的技术原因进行进一步说明）



