

User's Manual

ColorEdge®

CE210W

CE240W

Calibration Color LCD Monitor

Important

Please read this User's Manual carefully to familiarize yourself with safe and effective usage procedures.

Please retain this manual for future reference.

SAFETY SYMBOLS	2
PRECAUTIONS	3
1. INTRODUCTION	7
1-1. Features	7
1-2. Package Contents	8
1-3. Controls & Connectors	9
2. CABLE CONNECTION	11
2-1. Before Connecting	11
2-2. Connecting the Signal Cable	12
2-3. Connecting Two PCs to the Monitor	16
3. ScreenManager	18
3-1. How to use the ScreenManager	18
3-2. ScreenManager Adjustments and Settings	19
3-3. FineContrast	19
3-4. Useful Functions	21
4. ADJUSTMENT	23
4-1. Screen Adjustment	23
4-2. Displaying Lower Resolutions	26
4-3. Color Adjustment	27
4-4. Power-save Setup	29
5. MAKING USE OF USB (Universal Serial Bus)	30
6. ATTACHING AN ARM	32
7. TROUBLESHOOTING	34
8. CLEANING	37
9. SPECIFICATIONS	38
10. GLOSSARY	44
11. APPENDIX/ANHANG/ANNEXE	46
About TCO'03	48
FCC Declaration of Conformity	49
Hinweis zur Ergonomie / Recycle Auskunft / Hinweise zur Auswahl des richtigen Schwenkarms für Ihren Monitor	50



SAFETY SYMBOLS

This manual uses the safety symbols below. They denote critical information. Please read them carefully.

	WARNING Failure to abide by the information in a WARNING may result in serious injury and can be life threatening.
	CAUTION Failure to abide by the information in a CAUTION may result in moderate injury and/or property or product damage.
	Indicates a prohibited action.
	Indicates to ground for safety.

Copyright© 2006-2007 EIZO NANA O CORPORATION All rights reserved. No part of this manual may be reproduced, stored in a retrieval system, or transmitted, in any form or by any means, electronic, mechanical, or otherwise, without the prior written permission of EIZO NANA O CORPORATION.

EIZO NANA O CORPORATION is under no obligation to hold any submitted material or information confidential unless prior arrangements are made pursuant to EIZO NANA O CORPORATION's receipt of said information. Although every effort has been made to ensure that this manual provides up-to-date information, please note that EIZO monitor specifications are subject to change without notice.

ENERGY STAR is a U.S. registered mark.

Apple, Macintosh, Power Macintosh and Power Mac are registered trademarks of Apple Inc.

VGA is a registered trademark of International Business Machines Corporation.

DPMS is a trademark and VESA is a registered trademark of Video Electronics Standards Association.

Windows is a registered trademark of Microsoft Corporation.

PowerManager and ColorNavigator are trademarks of EIZO NANA O CORPORATION.

ScreenManager, ColorEdge and EIZO are registered trademarks of EIZO NANA O CORPORATION

	As an ENERGY STAR® Partner, EIZO NANA O CORPORATION has determined that this product meets the ENERGY STAR guidelines for energy efficiency.
--	--

Product specifications may vary depending on the region. Confirm the specifications in the manual written in the language of the region of purchase.
--

PRECAUTIONS

IMPORTANT!

- This product has been adjusted specifically for use in the region to which it was originally shipped. If operated outside the region to which it was originally shipped, the product may not perform as stated in the specifications.
- To ensure personal safety and proper maintenance, please read this section and the caution statements on the unit (refer to the figure below).

[Location of the Caution Statements]

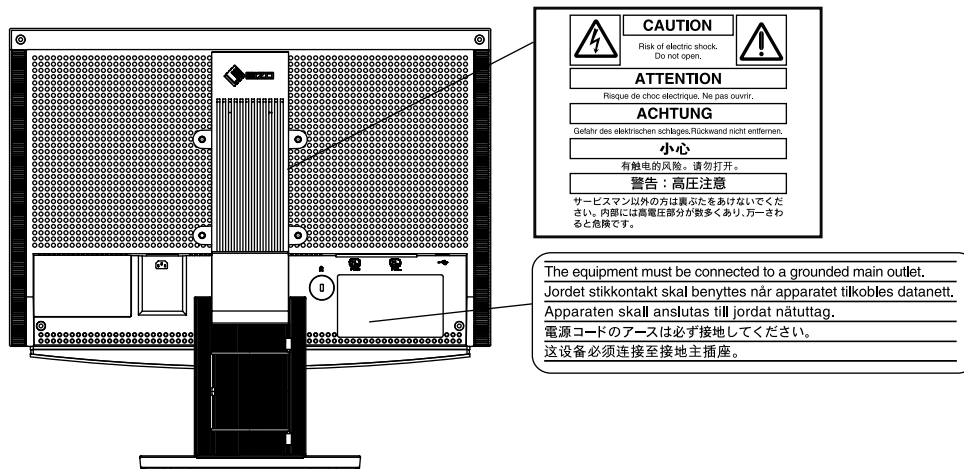

WARNING

If the unit begins to emit smoke, smells like something is burning, or makes strange noises, disconnect all power connections immediately and contact your dealer for advice.

Attempting to use a malfunctioning unit may result in fire, electric shock, or equipment damage.

Do not open the cabinet or modify the unit.

Opening the cabinet or modifying the unit may result in fire, electric shock, or burn.



Refer all servicing to qualified service personnel.

Do not attempt to service this product yourself as opening or removing covers may result in fire, electric shock, or equipment damage.

Keep small objects or liquids away from the unit.

Small objects accidentally falling through the ventilation slots into the cabinet or spillage into the cabinet may result in fire, electric shock, or equipment damage. If an object or liquid falls/spills into the cabinet, unplug the unit immediately. Have the unit checked by a qualified service engineer before using it again.

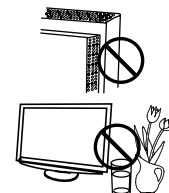

⚠ WARNING

Place the unit at the strong and stable place.

A unit placed on an inadequate surface may fall and result in injury or equipment damage. If the unit falls, disconnect the power immediately and ask your dealer for advice. Do not continue using a damaged unit. Using a damaged unit may result in fire or electric shock.

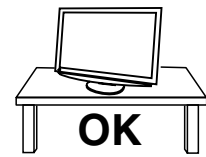

Set the unit in an appropriate location.

Not doing so may result in fire, electric shock, or equipment damage.

- Do not place outdoors.
- Do not place in the transportation system (ship, aircraft, trains, automobiles, etc.)
- Do not place in a dusty or humid environment.
- Do not place in a location where the steam comes directly on the screen.
- Do not place near heat generating devices or a humidifier.

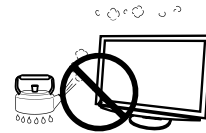

To avoid danger of suffocation, keep the plastic packing bags away from babies and children.

Use the enclosed power cord and connect to the standard power outlet of your country.

Be sure to remain within the rated voltage of the power cord. Not doing so may result in fire or electric shock.

Power supply: 100-120/200-240 Vac, 50/60 Hz

To disconnect the power cord, grasp the plug firmly and pull.

Tugging on the cord may damage and result in fire or electric shock.



The equipment must be connected to a grounded main outlet.

Not doing so may cause in fire or electric shock.



Use the correct voltage.

- The unit is designed for use with a specific voltage only. Connection to another voltage than specified in this User's Manual may cause fire, electric shock, or equipment damage.

Power supply: 100-120/200-240 Vac, 50/60 Hz

- Do not overload your power circuit, as this may result in fire or electric shock.

Handle the power cord with care.

- Do not place the cord underneath the unit or other heavy objects.
- Do not pull on or tie the cord.



If the power cord becomes damaged, stop using it. Use of a damaged cord may result in fire or electric shock.

Never touch the plug and power cord if it begins to thunder.

Touching them may result in electric shock.



WARNING

When attaching an arm stand, please refer to the user's manual of the arm stand and install the unit securely.

Not doing so may cause the unit to come unattached, which may result in injury or equipment damage. When the unit is dropped, please ask your dealer for advice. Do not continue using a damaged unit. Using a damaged unit may result in fire or electric shock. When reattaching the tilt stand, please use the same screws and tighten them securely.

Do not touch a damaged LCD panel directly with bare hands.

The liquid crystal which leaks from the panel is poisonous if it enters the eyes or mouth.

If any part of the skin or body comes in direct contact with the panel, please wash thoroughly. If some physical symptoms result, please consult your doctor.



Lamps contain mercury, dispose according to local, state or federal laws.

CAUTION

Handle with care when carrying the unit.

Disconnect the power cord and cables when moving the unit. Moving the unit with the cord attached is dangerous. It may result in injury.

When handling the unit, grip the bottom of the unit firmly with both hands ensuring the panel faces outward before lifting.

Dropping the unit may result in injury or equipment damage.

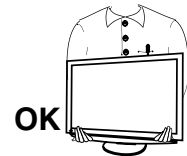

Do not block the ventilation slots on the cabinet.

- Do not place any objects on the ventilation slots.
- Do not install the unit in a closed space.
- Do not use the unit laid down or upside down.

Blocking the ventilation slots prevents proper airflow and may result in fire, electric shock, or equipment damage.

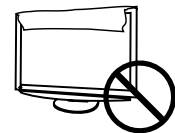

Do not touch the plug with wet hands.

Doing so may result in electrical shock.



Use an easily accessible power outlet.

This will ensure that you can disconnect the power quickly in case of a problem.

Periodically clean the area around the plug.

Dust, water, or oil on the plug may result in fire.

Unplug the unit before cleaning it.

Cleaning the unit while it is plugged into a power outlet may result in electric shock.

If you plan to leave the unit unused for an extended period, disconnect the power cord from the wall socket after turning off the power switch for the safety and the power conservation.

LCD Panel

In order to suppress the luminosity change by long-term use and to maintain the stable luminosity, use of a monitor in lower brightness is recommended.

The LCD panel is manufactured using high-precision technology. However, note that the appearance of any missing pixels or lit pixels does not indicate damage to the LCD monitor.

Percentage of effective pixels:99.9994%or higher.

The backlight of the LCD panel has a fixed life span. When the screen becomes dark or begins to flicker, please contact your dealer.

Do not press on the panel or edge of the frame strongly, as this may result in damage to the screen. There will be prints left on the screen if the pressed image is dark or black. If pressure is repeatedly applied to the screen, it may deteriorate or damage your LCD panel. Leave the screen white or black to decrease the prints

When the screen image is changed after displaying the same image for extended periods of time, an afterimage may appear. Use the screen saver or timer to avoid displaying the same image for extended periods of time.

When the monitor is cold and brought into a room or the room temperature goes up quickly, dew condensation may occur inside and outside the monitor. In that case, do not turn the monitor on and wait until dew condensation disappears, otherwise it may cause some damages to it.

Do not scratch or press on the panel with any sharp objects, such as a pencil or pen as this may result in damage to the panel. Do not attempt to brush with tissues as this may scratch the LCD panel.

1. INTRODUCTION

Thank you very much for choosing an EIZO Color Monitor.

1-1. Features

CE210W

- 21" wide format LCD
- Dual inputs compliant (DVI-I x 2)
- DVI Digital input (TMDS) compliant
- [Horizontal scanning frequency]
 - Analog: 24 - 82 kHz
 - Digital: 31 - 65 kHz
- [Vertical scanning frequency]
 - Analog: 49 - 86 Hz (1280x1024: 49-76Hz/1680x1050: 49 -61Hz)
 - Digital: 59 - 61 Hz (VGA text: 69 - 71 Hz)
- [Resolution] 1680 dots x 1050 lines
- Frame Synchronous mode supported (59 - 61 Hz)
- Support to sRGB standard
- The provided "ColorNavigator CE" calibration software enables you to calibrate monitor characteristics and generate ICC profiles (for Windows) and Apple ColorSync profiles (for Macintosh) (refer to the EIZO LCD Utility Disk)
- Smoothing function incorporated for the adjustment of an enlarged image
- FineContrast modes, to select the most suitable mode for screen display
- The ArcSwing Stand enables to adjust the monitor height and monitor angle freely .

CE240W

- 24" wide format LCD
- Dual inputs compliant (DVI-I x 2)
- DVI Digital input (TMDS) compliant
- [Horizontal scanning frequency]
 - Analog: 24 - 94 kHz
 - Digital: 31 - 76 kHz
- [Vertical scanning frequency]
 - Analog: 49 - 86 Hz (1600x1200: 49-76Hz/1920x1200: 49 -61Hz)
 - Digital: 59 - 61 Hz (VGA text: 69 - 71 Hz)
- [Resolution] 1920 dots x 1200 lines
- Frame Synchronous mode supported (59 - 61 Hz)
- Support to sRGB standard
- The provided "ColorNavigator CE" calibration software enables you to calibrate monitor characteristics and generate ICC profiles (for Windows) and Apple ColorSync profiles (for Macintosh) (refer to the EIZO LCD Utility Disk)
- Smoothing function incorporated for the adjustment of an enlarged image
- FineContrast modes, to select the most suitable mode for screen display
- The ArcSwing Stand enables to adjust the monitor height and monitor angle freely .

1-2. Package Contents

Please contact your local dealer for assistance if any of the listed items are missing or damaged.

- LCD Monitor
- Power Cord
- Analog Signal Cable (FD-C16)
- Digital Signal Cable (FD-C39)
- EIZO USB Cable (MD-C93)
- "EIZO LCD Utility Disk" CD-ROM
- Calibration software "ColorNavigator CE" (in the CD-ROM)
- ColorNavigator CE" Quick Reference
- User's Manual (in the CD-ROM)
- Setup Manual
- LIMITED WARRANTY
- Adjustment Certificate
- Mounting Screws (M4 x 12 mm)
CE210W:4 pcs, CE240W:6 pcs

NOTE

- Please retain the packing materials for future transference.
-

1-3. Controls & Connectors

Front

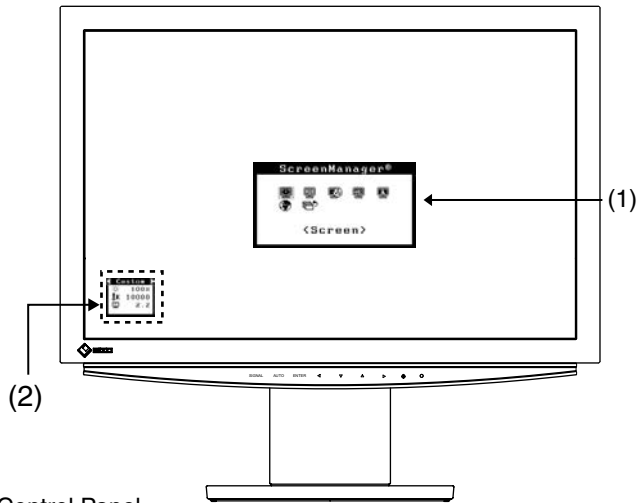

Control Panel

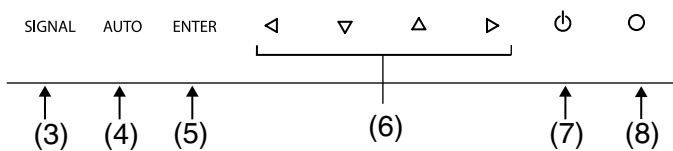

(1) ScreenManager®	Monitor Adjustment menu
(2) Monitor Adjustment menu	Directly touching the left or right button allows you to select a FineContrast mode.
(3) Input Signal Selection Switch(SIGNAL)	Switch the input signals when connecting 2 PCs.
(4) Auto Adjustment Switch (AUTO)	Adjust the screen to appropriate condition automatically (analog input only).
(5) Enter Switch (ENTER)	Show the ScreenManager on the screen. Confirm the setting / adjustment function. Save the adjustment values.
(6) Directing Switch (<▽△>)	Select the desired function. Increase and decrease the adjustment value.
(7) Power Switch (⏻)	ON or OFF the monitor's power.
(8) Power Indicator	Indicate monitor's operation status. Blue : Operation Flashing blue : Last 15 min. of operation time before entering the power off state. Orange : Power saving Off : Power off

Rear / Side / Bottom (CE210W is given as an example.)

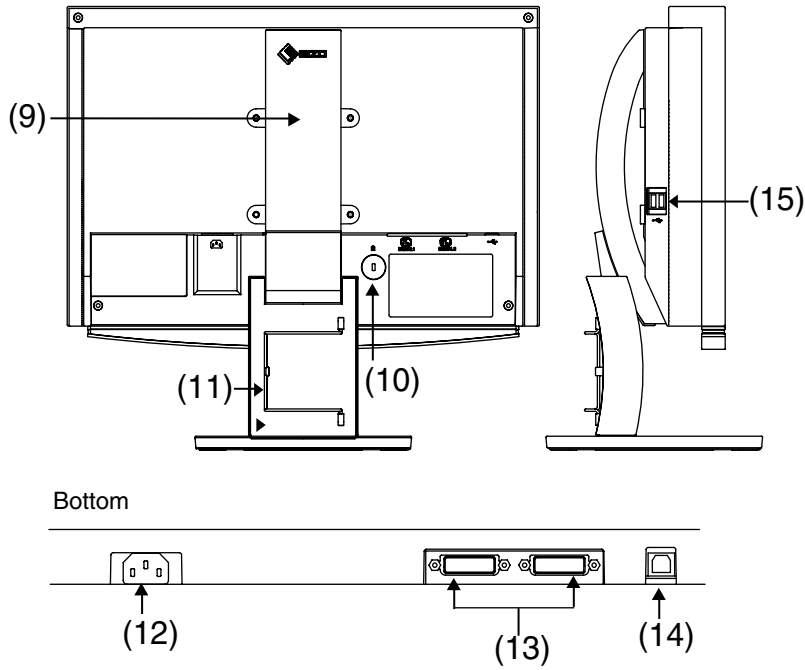

(9) Stand (Detachable)	The LCD monitor can be used with an optional arm stand by removing the stand (See " 6. ATTACHING AN ARM ").
(10) Security Lock Slot	Allows for connection of a security cable. This lock supports Kensington's MicroSaver security system. For further information, please consult: Kensington Technology Group 2855 Campus Drive, San Mateo, CA 94403 USA Tel.: 800-650-4242, x3348, Intl: 650-572-2700, x3348 Fax: 650-572-9675 http://www.kensington.com
(11) Cable Holder	House the cables
(12) Power Connector	Connect the power cord.
(13) DVI-I Input (SIGNAL1/SIGNAL2)	Connect the signal cable .
(14) USB Port (1 Upstream)	See 5. Making Use of USB Section.
(15) USB Port (2 Downstream)	

2. CABLE CONNECTION

2-1. Before Connecting

Before connecting your monitor to the PC, change the display screen settings (Resolution and frequency) in accordance with the charts below.

Tips

- It is recommended to use this monitor in the digital signal input.
- When your computer and display support VESA DDC, the suitable resolution and the refresh rate are set by just plugging your display into the computer without any manual settings.

Analog Input

CE210W

Resolution	Frequency	Dot Clock	Remarks
640×480	67Hz	150 MHz (Max.)	Apple Macintosh
640×480	~85Hz		VGA, VESA
720×400	70Hz		VGA TEXT
800×600	~85Hz		VESA
832×624	75Hz		Apple Macintosh
1024×768	~85Hz		VESA
1152×864	75Hz		VESA
1152×870	75Hz		Apple Macintosh
1280×960	60Hz		VESA
1280×960	75Hz		Apple Macintosh
1280×1024	~75Hz		VESA
1680×1050	60Hz		VESA CVT, VESA CVT RB (Reduced Blanking)

CE240W

Resolution	Frequency	Dot Clock	Remarks
640×480	67Hz	202.5 MHz (Max.)	Apple Macintosh
640×480	~85Hz		VGA, VESA
720×400	70Hz		VGA TEXT
800×600	~85Hz		VESA
832×624	75Hz		Apple Macintosh
1024×768	~85Hz		VESA
1152×864	75Hz		VESA
1152×870	75Hz		Apple Macintosh
1280×960	60Hz		VESA
1280×960	75Hz		Apple Macintosh
1280×1024	~85Hz		VESA
1600×1200	~75Hz		VESA
1680×1050	60Hz		VESA CVT, VESA CVT RB (Reduced Blanking)
1920×1200	60Hz		VESA CVT, VESA CVT RB (Reduced Blanking)

Digital Input

The monitor supports the following resolutions only.

CE210W

Resolution	Frequency	Dot Clock	Remarks
640×480	60Hz	120 MHz (Max.)	VGA
720×400	70Hz		VGA TEXT
800×600	60Hz		VESA
1024×768	60Hz		VESA
1280×960	60Hz		VESA
1280×1024	60Hz		VESA
1680×1050	60Hz		VESA CVT RB (Reduced Blanking)

CE240W

Resolution	Frequency	Dot Clock	Remarks
640×480	60Hz	162 MHz (Max.)	VGA
720×400	70Hz		VGA TEXT
800×600	60Hz		VESA
1024×768	60Hz		VESA
1280×960	60Hz		VESA
1280×1024	60Hz		VESA
1600×1200	60Hz		VESA
1680×1050	60Hz		VESA CVT, VESA CVT RB (Reduced Blanking)
1920×1200	60Hz		VESA CVT RB (Reduced Blanking)

2-2. Connecting the Signal Cable

NOTE

- Be sure that the power switches of both the PC and the monitor are OFF.

- 1** Plug the signal cable into the connector at the rear of the monitor and the other end of the cable into the video connector on the PC.

After connecting, secure the connection with the screw-in fasteners.

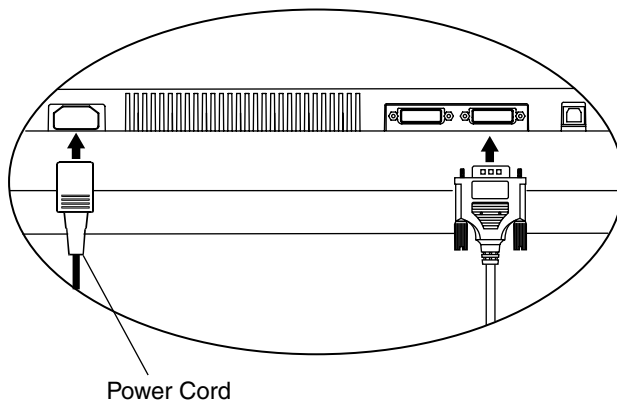

Analog Input

Signal Cable	Connector of the PC	PC
Signal Cable (FD-C16 enclosed) 	Video Output Connector / D-Sub mini 15 pin Input Connector(monitor) / DVI	<ul style="list-style-type: none"> • Standard graphics card • Power Macintosh G3 (Blue & White) / Power Mac G4 (VGA)

Digital Input

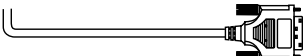
Signal Cable	Connector of the PC	PC
Signal Cable (FD-C39 enclosed) 	Video Output Connector / DVI Input Connector (monitor) / DVI	<ul style="list-style-type: none"> • Digital Graphics card • Power Mac G4/G5 (DVI)

NOTE

- The monitor is not compatible with a Power Mac G4/G5 ADC (Apple Display Connector).

- 2** Plug the power cord into the power connector on the rear of the monitor.
- 3** Plug the other end of the power cord into a power outlet.

WARNING

Use the enclosed power cord and connect to the standard power outlet of your country.
Be sure to remain within the rated voltage of the power cord. Not doing so may result in fire or electric shock.

The equipment must be connected to a grounded main outlet.
Not doing so may result in fire or electric shock.

4 Lead the power cord and signal cable into the cable holder at rear of the monitor.

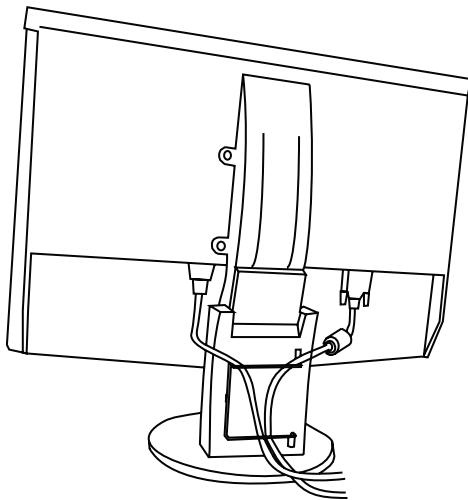

NOTE

- The cables are recommended to lead with slight sag for the smooth motion of the stand.

5 Adjust the "height", "front and back position" and "angle" of the monitor.

1. Adjust the height of the monitor. To heighten, push the monitor backward. To lower, pull the monitor forward.

Grip both side of the center part of the monitor and move slowly (refer to the right figure.)

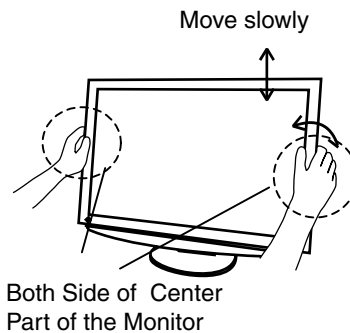

2. Adjust the position and angle of the monitor. To adjust the angle of the monitor, hold the stand with one hand and tilt the monitor with another hand by holding the upper side of the cabinet.

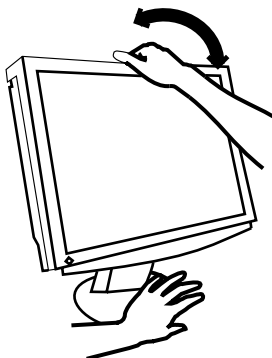

3. If necessary, fine adjust the height of the monitor.

6 Turn on the monitor's Power switch and then turn on the PC's power.

The monitor's power indicator will light up (blue).

If an image does not appear, refer to the " 7. TROUBLESHOOTING" for advice.

Whenever finished, turn off the PC and the monitor.

Tips

- When turning on the monitor, the kind of the input signal (Signal1 or 2/Analog or Digital) is displayed for a few seconds on the right top corner of the screen.
- Adjust brightness of the screen depending on the brightness of your environment. Too dark or too bright of a screen can cause eyestrain.
- Be sure to take adequate rests. A 10-minute rest period each hour is suggested.

7 When using the software, ColorNavigator CE, connect the upstream port of the monitor to the downstream port of the USB compliant PC or another hub with the USB cable.

After connecting the USB cable, the USB function can be set up automatically. For further details about the "ColorNavigator CE", refer to the readme.txt in the CD-ROM.

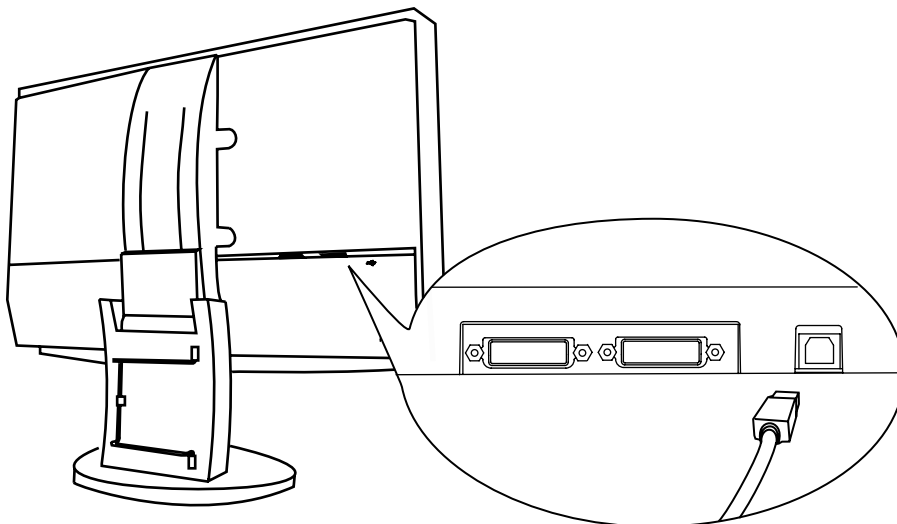

USB Cable

2-3. Connecting Two PCs to the Monitor

Two PCs can be connected to the monitor through the DVI-I and the D-Sub mini 15 pin connector on the back of the monitor.

Connecting Examples

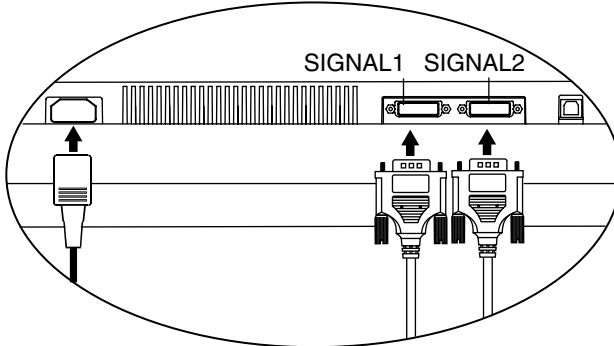

		SIGNAL 1		SIGNAL 2		
(Ex.1)	Analog	D-Sub mini 15 pin	Signal Cable (FD-C16 enclosed) 	Signal Cable (FD-C39 enclosed) 	DVI	Digital
(Ex.2)	Analog	D-Sub mini 15 pin	Signal Cable (FD-C16 enclosed) 	Signal Cable (FD-C16 optional) 	D-Sub mini 15 pin	Analog
(Ex.3)	Digital	DVI	Signal Cable (FD-C39 enclosed) 	Signal Cable (FD-C39 optional) 	DVI	Digital

Selecting the Active Input

The Input Signal Selection switch on the control panel can be used to select either SIGNAL 1 or SIGNAL 2 as the active input at any time. Every time the switch is touched, the input changes. When switching the signal, the kind of the input signal (Signal 1 or 2/ Analog or Digital) is displayed for a few seconds on the right top corner of the screen.

This function is used to select which PC will have priority to control the monitor when utilizing two PCs.

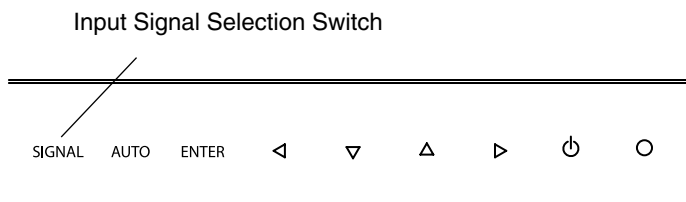

The monitor constantly checks the input signals and switches automatically in accordance with the "Input Priority" setting (see table below). Once a priority is set, whenever a change of signal is detected at the selected input, the monitor will switch the input to that signal.

In the case of only one signal being present at either input, the monitor automatically detects and displays that signal.

Priority setting	Performance
1	If signals from both inputs are present, the monitor gives preference to Signal 1 in the following cases. <ul style="list-style-type: none">• When the power of the monitor is turned ON.• When the signal input to Signal 1 is changed even if active input was Signal 2.
2	If signals from both inputs are present, the monitor gives preference to Signal 2 in the following cases. <ul style="list-style-type: none">• When the power of the monitor is turned ON.• When the signal input to Signal 2 is changed even if active input was Signal 1..
Manual	The monitor will not detect signals automatically in this mode. Select the active input by pressing the Input Signal Selection Button on the monitor's control panel.

NOTE

- When the "1" or "2" is selected, the power saving mode of the monitor activates only if both PCs are in power saving mode.
-

3. ScreenManager

3-1. How to use the ScreenManager

ScreenManager allows you to adjust screen performance through the main menu and select a FineContrast mode easily.

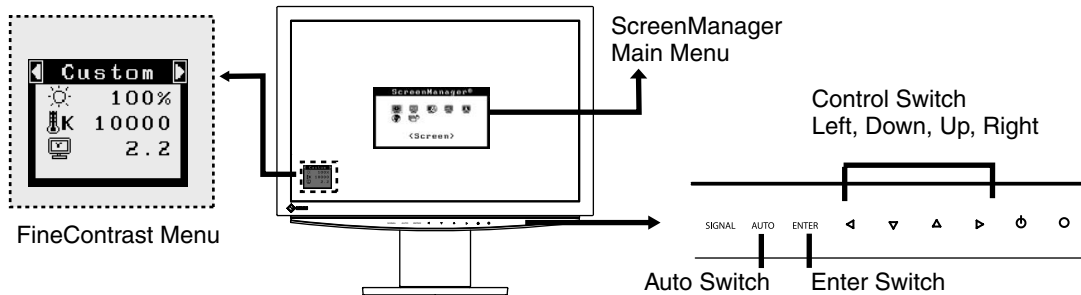

NOTE

- Main Menu and FineContrast Menu cannot be activated at the same time.

1 Entering the ScreenManager

Touch the Enter switch once to display the main menu of the ScreenManager.

2 Making Adjustments and Settings

1. Select the desired sub menu icon using the Directing switch and touch the Enter switch. The sub menu appears.
2. Use the Directing switches to select the desired setting icon and touch the Enter switch. The setting menu appears.
3. Use the Directing switches to make all required adjustments and touch the Enter switch to save the settings.

3 Exiting the ScreenManager

1. To return to the main menu, select the <Return> icon or touch the Down switch twice, followed by the Enter switch.
2. To exit the ScreenManager, select <Exit> icon or touch the Down switch twice, followed by the Enter switch.

Tips

- Double clicking the Enter switch at any time also exits the ScreenManager menu.

FineContrast Menu

Directly touching the left or right switch allows you to select the best suited mode for screen display from 3 FineContrast modes; sRGB, Custom and CAL. To exit the menu, touch the Enter switch.

3-2. ScreenManager Adjustments and Settings

The following table shows all the ScreenManager's adjustment and setting menus. "*" indicates adjustments of analog input only and "***" indicates digital input only.

Main menu	Sub menu		Reference	
Screen	Clock	*	4-1. Screen Adjustment..	
	Phase	*		
	Position	*		
	Resolution	*		
	Range Adjustment	*		
	Smoothing			
	Signal Filter	*		
Color(Custom) * ¹	Brightness		4-3. Color Adjustment.	
	Temperature			
	Gamma			
	Saturation			
	Hue			
	Gain			
	6 Colors			
	Reset			
PowerManager	DVI DMPM	**	4-4. Power-save Setup.	
	VESA DPMS	*		
	OFF			
Others	Screen Size		4-2. Displaying Lower Resolutions	
	Border Intensity			
	Input Priority		Select the Priority Input Signal.	
	Off Timer		Set the monitor's Off Timer to on or off.	
	Beep		Set the monitor's beeper to on or off. (Beeper settings.)	
	Menu Settings	Menu Size		Change the size of the menu.
		Menu Position		Adjust the menu position.
		Menu Off Timer		Set the menu displaying time.
		Translucent		Set the transparency of the background.
	Power Indicator		Make non-light for blue lighting when the screen is displayed. (Power Indicator Setting.)	
Reset		Return to the factory Default settings.		
Information	Information		Review the ScreenManager's settings, model name, serial number and usage time. * ²	
Language	English, German, French, Spanish, Italian, Swedish and Japanese		Select the ScreenManager's language.	

*¹The adjustable functions on the <Color> menu depend on the selected FineContrast mode. The above table shows the sub menus when the "Custom" mode is selected (See " 4-3. Color Adjustment. ").

*²Due to the inspection on the factory, the usage time may not "0 hour" at shipping.

3-3. FineContrast

This function allows you to select the best suited mode for screen display.

To select the Mode

Touching the Left or Right switch allows you to select the best suited mode for screen display from 3 FineContrast modes; sRGB, Custom and CAL. Color settings each mode can be adjusted by using the <Color> menu of the ScreenManager.

Tips

- When the main menu of ScreenManager is displayed on the screen, the FineContrast Menu cannot be activated.

Exit

Press the Enter switch to exit the menu.

FineContrast Mode

Selectable FineContrast modes are as follows.

Mode	Description
sRGB	To display the screen images based on those original colors (ex. over the Internet)
Custom	To adjust the color settings according to your preference
CAL	The mode only for calibration software

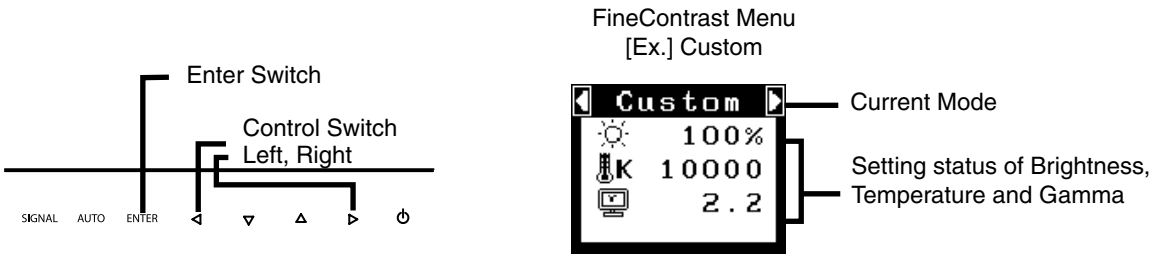

Color Adjustment of the Mode Settings

<Brightness>, <Temperature> and <Gamma> settings can be adjusted on the FineContrast menu. Select the desired function icon with the Up/Down Directing switches and adjust with the Left/Right Directing switches. (Setting(s) of <Temperature> and/or <Gamma> is defined as standard default in some modes. ("4-3. Color Adjustment.")

Detailed Adjustments

The detailed color settings of each mode can be adjusted by using the <Color> menu of the ScreenManager. ("4-3. Color Adjustment.")

NOTE

- "CAL" mode can be adjusted only by Calibration Software "ColorNavigator CE".

3-4. Useful Functions

Adjustment Lock

Use the "Adjustment Lock" function to prevent any accidental changes.

Locked function	<ul style="list-style-type: none"> • Adjustments and settings in the ScreenManager • Auto Adjustment Switch
Unlocked function	<ul style="list-style-type: none"> • Selecting of the FineContrast mode by the Directing Switch / Adjustments • Brightness adjustment by the Directing Switch • Input signal selection switch

[How To lock]

1. Turn off the monitor's power by touching the power switch.
2. And then touch the power switch while touching the Auto Adjustment switch.

[How To unlock]

1. Turn off the monitor's power by touching the power switch.
2. And then touch the power switch while touching the Auto Adjustment switch once again.

Off Timer

The off timer function causes the monitor to automatically enter a power off state after a predetermined amount of time has lapsed. This function was created to reduce Afterimage characteristics that are particular to LCD monitors when the monitor screen is left on for a long period without use.

[Procedure]

1. Select <Off Timer> in the ScreenManager <Others> menu.
2. Select "Enable" and touch the Right and Left directing switches to adjust the operating time (1 to 23 hours).

[Off Timer System]

PC	Monitor	Power Indicator
Operating time (1H - 23H)	Operation	Blue
Last 15 min. in operating time	Advance Notice ^{*1}	Blue Flashing
Operating time expired	Power Off	Off

^{*1} By touching the power switch on the control panel during the Advance Notice period, the operating time can be reset to 90 minutes. Resetting can be performed an unlimited number of times.

[Power Resumption Procedure]

Touch the power switch to return a normal screen.

NOTE

- The off timer function works while the PowerManager is active, but there is no advance notice before the monitor's power is turned off.

Power Indicator Setting

Light off the power indicator. This function is available for the multiple panels settings.

[Procedure]

1. Select <Power Indicator> in the ScreenManager <Others> menu.
2. Select "Disable".

EIZO Logo Appearing Function

When turning on the monitor, the EIZO logo is displayed for a while. If you desire to display or undisplay this logo, use this function. (Default is logo appearing.)

[To undisplay]

1. Turn off the monitor's power by touching the power switch.
2. Touch the power switch while touching the Enter switch, and this logo is not displayed.

[To display]

1. Turn off the monitor's power by touching the power switch.
2. Touch the power switch while touching the Enter switch, and this logo is not displayed again.

4. ADJUSTMENT

4-1. Screen Adjustment

NOTE

- Allow the LCD monitor to stabilize for at least 30 minutes before making image adjustments.

The monitor displays the digital input image correctly based on its pre-setting data.

Analog Input

Screen adjustments for the LCD monitor should be used in suppressing screen flickering and also for adjusting the screen to its proper position. There is only one correct position for each display mode. It is also recommended to use the ScreenManager function when first installing the display or whenever changing the system. For convenience, an easy set-up Program installed on the utility disk to assist in the set-up procedure is provided.

Adjustment Procedure

1 Touch the Auto Adjustment Switch on the control panel.

The message appears and remains on the screen for 5 seconds. While the message is on the screen, touch the Auto Adjustment switch again to automatically adjust the clock, phase, screen position and resolution. If you do not wish to do adjust the screen, do not touch the Auto Adjustment switch again.

NOTE

- The Auto adjustment function is intended for use on the Macintosh and on AT-compatible PC running Windows. It may not work properly in either of the following cases. When running an AT-compatible PC on MS-DOS (Not windows). The background color for the "wall paper" or "desktop" pattern is set to black.
- It cannot work correctly using with some graphics cards.

If the appropriate screen cannot be made by using the Auto Adjustment switch, adjust the screen through the following procedures. If the appropriate screen can be made, proceed to 4. Range Adjustment .

2 Run the "Screen Adjustment Program".

Having read the "Readme.txt" file, run the "Screen Adjustment Program" in the enclosed EIZO LCD Utility Disk. Step by step, adjustment is provided by the wizard guide. (If using the Windows, the program can be directly run from the menu screen of the CD-ROM.)

Tips

- If the user's operating system has no utility disk (e.g. OS/2), we recommend setting the desktop pattern to that as shown in the diagram on the following.

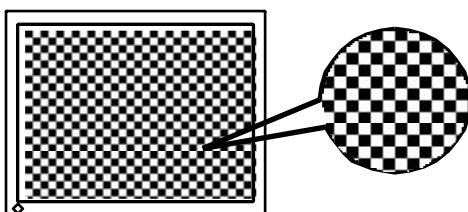

3 Adjust by using <Screen> menu in the ScreenManager.

(1) Vertical bars appear on the screen

→  Use the <Clock> adjustment.

Select the <Clock> and eliminate the vertical bars by using the Right and Left of the Directing switches. Do not continuously touch the Directing switches, as the adjustment value will change quickly and make it difficult to locate the most suitable adjustment point. If the horizontal flickering, blur or bars appear, proceed to <Phase> adjustment as follows.

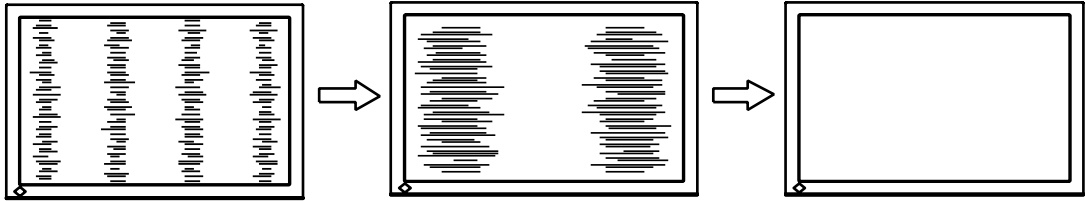

(2) Horizontal flickering, blurring or bars appear on the screen.

→  Use the <Phase> adjustment.

Select the <Phase> and eliminate the horizontal flickering, blurring or bars by using the Right and Left switches.

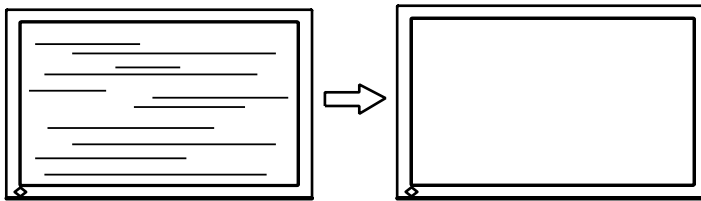

NOTE

- Horizontal bars may not completely disappear from the screen depending on the PC.

(3) The screen position is incorrect.

→  Use the <Position> adjustment.

The correct displayed position of the monitor is decided because the number and the position of the pixels are fixed. The <Position> adjustment moves the image to the correct position.

Select <Position> and adjust the position by using the Up, Down, Right and Left switches. If vertical bars of distortion appear after finishing the <Position> adjustment, return to <Clock> adjustment and repeat the previously explained adjustment procedure.

("Clock" → "Phase" → "Position")

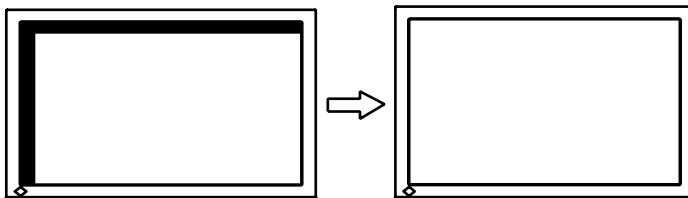

(4) Screen image is smaller or larger than the actual screen images.

→  Use the <Resolution> adjustment.

Adjustment is needed when the input signal resolution and the resolution now being displayed are different.

Select <Resolution> and confirm if the resolution now being displayed is the same as the input resolution. If it is not, adjust the vertical resolution using the Up and Down switches and adjust the horizontal resolution using the Right and Left switches.

Smaller than the actual screen images

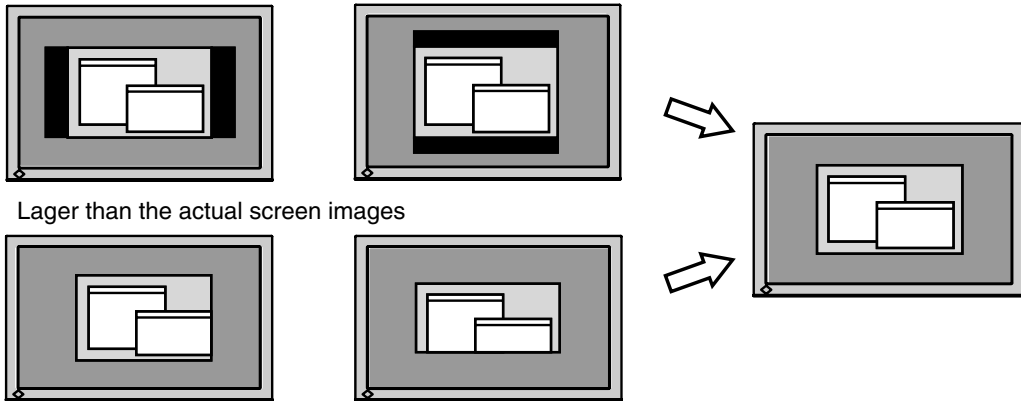

Larger than the actual screen images

4 Adjust the output signal range (Dynamic Range) of the signal.

→  Use the <Range Adjustment> of <Screen> menu.

This controls the level of output signal range to display the whole color gradation (256 colors).

[Procedure]

Select the <Range Adjustment> in the ScreenManager and touch the Auto Adjustment switch on the control panel to adjust the Range Adjustment.

The screen blanks for a moment and adjusts the color range to display the whole color gradation of the current output signal.

4-2. Displaying Lower Resolutions

The lower resolutions are enlarged to full screen automatically. Using the <Screen Size> function in the <Others> menu enables to change the screen size.

1 Enlarge the screen size when displaying a low resolution.

→  Select the <Screen Size>.

Select the <Screen Size> in the others menu and select the screen size by using the up and down switches.

Mode	Function
Full	Displays the picture on the screen in full, irrespective of the picture's resolution. Since the vertical resolution and the horizontal resolution are enlarged at different rates, some images may appear distorted.
Enlarged	Displays the picture on the screen in full, irrespective of the picture's resolution. Since the vertical resolution and horizontal resolution are enlarged at same rates, some horizontal or vertical image may disappear.
Normal	Displays the picture at the actual Screen resolution.

CE210W

Example: Displaying 1280 x 1024

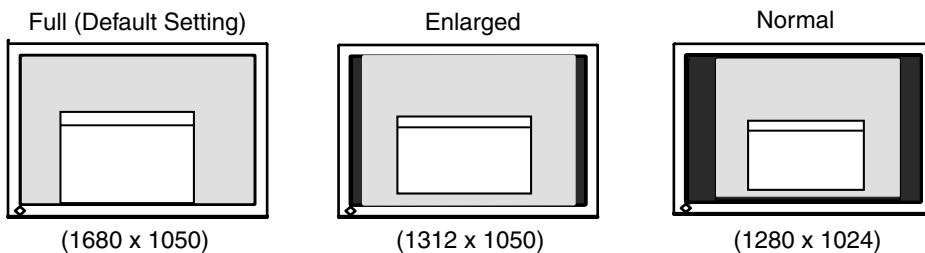

CE240W

Example: Displaying 1280 x 1024

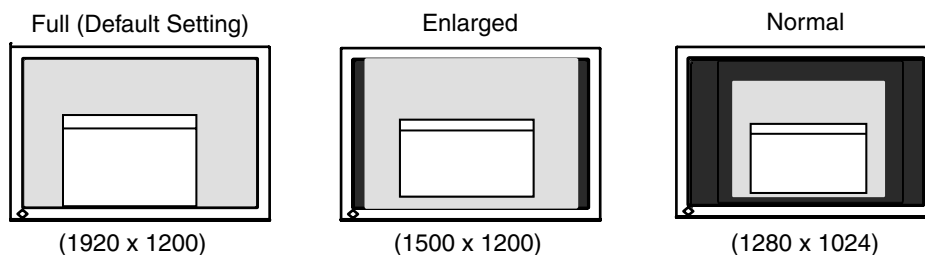

2 Smooth the blurred texts of the enlarged screen.

→  Switch the <Smoothing> setting.

Select the suitable level from 1 - 5 (Soft - Sharp).

Select <Smoothing> in the <Screen> menu and adjust by using the right and left switches.

NOTE

- <Smoothing> is disabled in the following cases.
 - Screen is displayed in the 1680 x 1050.(CE210W)
 - Screen is displayed in the 1920 x 1200.(CE240W)
 - "Enlarged" is selected in <Screen Size> at 800 x 600 resolution.(CE240W)
 - "Enlarged" is selected in <Screen Size> at 1600 x 1200 resolution.(CE240W)
 - "Normal" is selected in <Screen Size>.

3 Set the brightness of the black area surrounding the displayed image.

→  Set the <Border Intensity>.

In the <Enlarge> mode or <Full Screen> mode, the outer area (border) is usually black. Select <BorderIntensity> in the <Others> menu and adjust by using the right and left switches.

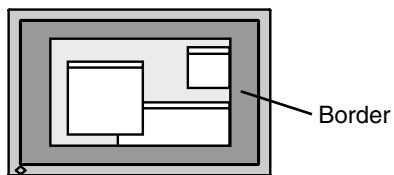

4-3. Color Adjustment









Color settings of each FineContrast mode can be adjusted and saved by using the <Color> menu of the ScreenManager.

In the analog input, perform the "Range Adjustment" before making the color adjustments. During color adjustments, the FineContrast mode cannot be changed. Select the mode in advance by using the FineContrast Mode.

Adjustment Items

The adjustable items and displayed icons on the <Color> menu depend on the selected FineContrast mode.

"√": Settable/Adjustable " - ": Fixed at the factory

Icons	Functions	FineContrast Mode		
		sRGB	Custom	CAL
	Brightness*	√	√	-
	Temperature*	-	√	-
	Gamma*	-	√	-
	Saturation	-	√	-
	Hue	-	√	-
	Gain	-	√	-
	6 colors	-	√	-
	Reset	-	√	-









* These settings can be also adjusted on the FineContrast menu. (See FineContrast.)

NOTE

- Allow the LCD monitor to stabilize for at least 30 minutes before making image adjustments. (Allow the monitor to warm up for at least 30 minutes before making adjustments.)
- The values shown in percentages represent the current level within the specific adjustment. They are available only as a reference tool. (To create a uniform white or black screen, the percentages for each will probably not be the same.)

4. ADJUSTMENT

Adjustment Contents

Menu	Function Descriptions	Adjustable range
Brightness 	To set the brightness of the screen	0~100%
	Tips <ul style="list-style-type: none"> • The values shown in the “%” are available only as a reference tool. • Directly touching the Up and Down switches also adjusts the brightness. Touch the Enter switch to save and exit the settings after the adjustment. 	
Temperature 	To set the color temperature	4000K~10000K in 500 K increments (including 9300 K)
	Tips <ul style="list-style-type: none"> • Setting the value to “Off” presents the natural color temperature of the panel. • The values shown in the Kelvin are available only as a reference tool. • Setting the temperature under 4000 K or over 10000 K invalidates the color temperature setting. (The color temperature's setting turns "OFF".) • Setting the <Gain> invalidates the <Temperature> adjustment. 	
Gamma 	To set the gamma value	1.8~2.6
	Tips <ul style="list-style-type: none"> • If setting the gamma value, the using the monitor in the digital signal input is recommended. If using the monitor in the analog input signal, set the gamma value from 1.8 to 2.2. 	
Saturation 	To change the saturation	-100~100 Setting the minimum level (-100) turns the image to the monochrome.
	NOTE <ul style="list-style-type: none"> • The <Saturation> adjustment may cause undisplayable color tone. 	
Hue 	To change the flesh color, etc.	-100~100
	NOTE <ul style="list-style-type: none"> • Using <Hue> adjustment may not obtain proper tone reproduction. 	
Gain 	To change each color (red, green and blue)	0~100% By adjusting the red, green and blue color tones for each mode, custom colors can be defined. Display a white or gray background image and adjust the <Gain>.
	Tips <ul style="list-style-type: none"> • The values shown in the “%” are available only as a reference tool. 	
6 colors 	To adjust <Saturation> and <Hue> in each color (Red, Yellow, Green, Cyan, Blue and Magenta)	Hue: -100 ~ 100 Saturation: -100 ~ 100
Reset 	To return the color settings to the default settings	Select the <Reset>.

4-4. Power-save Setup

The <PowerManager> menu in the ScreenManager enables to set the power-save setup.

NOTE

- Do your part to conserve energy, turn off the monitor when you are finished using it. Disconnecting the monitor from the power supply is recommended to save energy completely.
- Even if the monitor is in a power saving mode, USB compliant devices function when they are connected to the monitor's USB (both the upstream and the downstream ports). Therefore, power consumption of the monitor will change according to the connected devices even if the monitor is in a power saving mode.

Analog Input

This monitor complies with the "VESA DPMS" standard and adopts a power saving method.

[Procedure]

1. Set the PC's power saving settings.
2. Select "VESA DPMS" from the <PowerManager> menu.

[Power Saving System]

PC		Monitor	Power Indicator
Operation		Operation	Blue
Power saving	STAND-BY SUSPEND OFF	Power saving	Orange

[Power Resumption Procedure]

Operate the mouse or keyboard to return to a normal screen.

Digital Input

This monitor complies with the "DVI DMPM"

[Procedure]

1. Set the PC's power saving settings.
2. Select "DVI DMPM" from the <PowerManager> menu.

[Power Saving System]

PC		Monitor	Power Indicator
Operation		Operation	Blue
Power saving		Power saving	Orange

[Power Resumption Procedure]

Operate the mouse or keyboard to return to a normal screen.

5. MAKING USE OF USB (Universal Serial Bus)

This monitor provides a hub which supports the USB standard. When connecting to a USB compliant PC or another hub, the monitor functions as a hub to which the USB compliant peripherals can be easily connected.

Required system environment

- PC equipped with USB ports or another USB hub connected to the USB compliant PC
- Windows 98/2000/Me/XP // Mac OS 8.5.1 or later
- USB Cable (MD-C93, enclosed)

NOTE

- The USB hub function may not work properly depending on the PC or peripherals. Please consult the manufacturer of each device about the USB support.
- Using the USB Rev. 2.0 compatible PC or peripherals is recommended.
- If the monitor is in the power saving mode, or if the monitor is connected to the power outlet with the monitor turned off, all the devices connected to the USB ports (upstream and downstream) work. Therefore, power consumption of the monitor varies with connected devices even in the power saving mode.
- The followings are procedures for the Windows 98/Me/2000/XP and Mac OS.

Connecting to the USB HUB

- 1** Connect the monitor to the PC with the signal cable first, then turn on the PC.
- 2** Connect the upstream port of the monitor to the downstream port of the USB compliant PC or another hub by using the USB cable.

After connecting the USB cable, the USB function can be set up automatically.

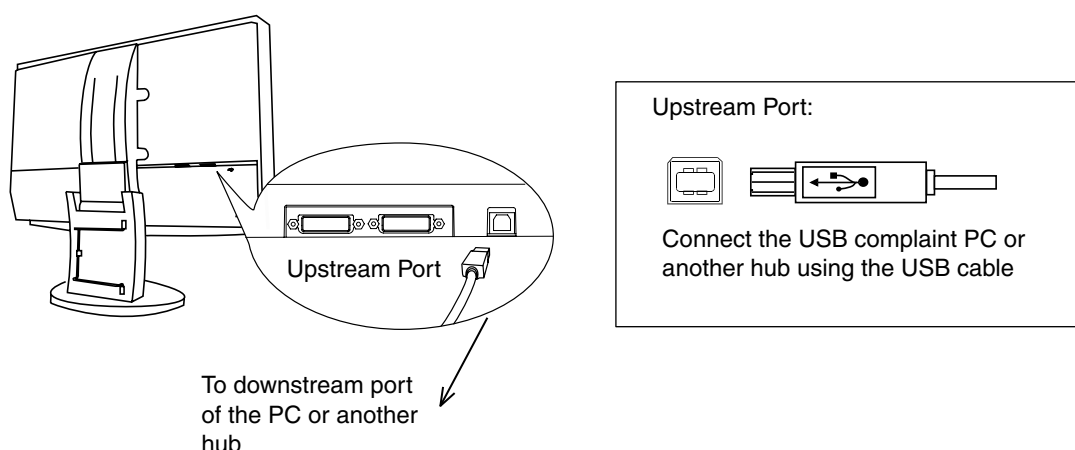

- 3** After setting up, the monitor's USB hub is available for connecting USB compliant peripherals to the downstream ports of the monitor.

Connecting Examples

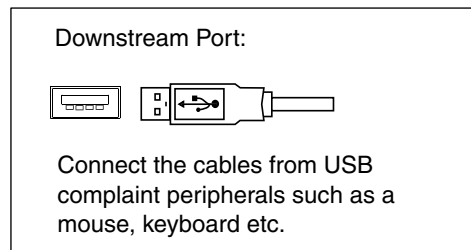
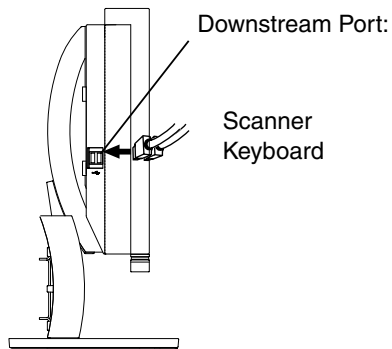
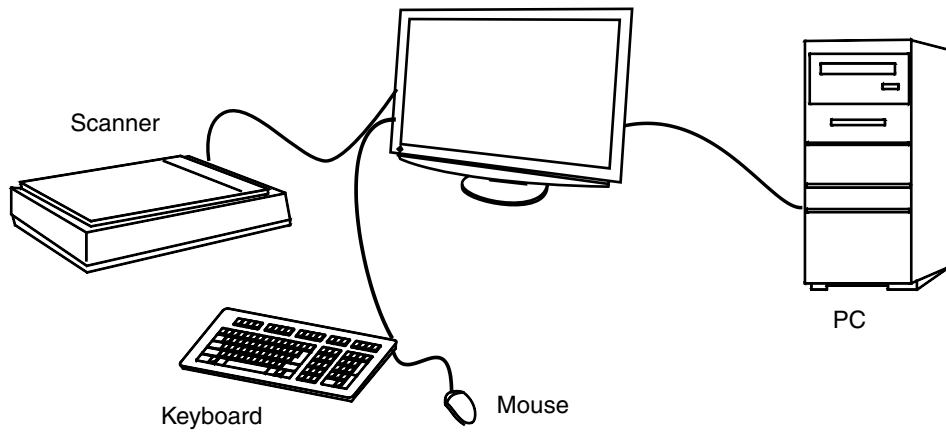

6. ATTACHING AN ARM

The LCD monitor can be used with an arm by removing the tilt stand and attaching the arm stand to the LCD monitor.

NOTE

- If you will use the arm or stand of other manufacturers, confirm the followings to the manufacturers before selecting.
 - Hole spacing on the arm mounting
 - CE210W : 100 mm x 100 mm (VESA compliant)
 - CE240W : 100 mm x 100 mm (VESA compliant) or 200 mm x 100 mm (VESA compliant)
 - Supportable Weight: Total weight of the monitor (without stand) and attaching equipment such as a cable
 - TÜV/GS approved arm or stand
- Please connect cables after attaching an arm stand.
- This monitor does not support the portrait display.

Setup Procedure

1 Lay the LCD monitor down. Do not scratch the panel.

2 Remove the tilt stand by loosening the screws

Unscrew the four screws securing the unit and the stand with the screwdriver.

3 Attach an arm stand to the LCD monitor securely.

Secure the monitor to the arm or stand using the screws specified in the user's manual of the arm or stand.

CE210W

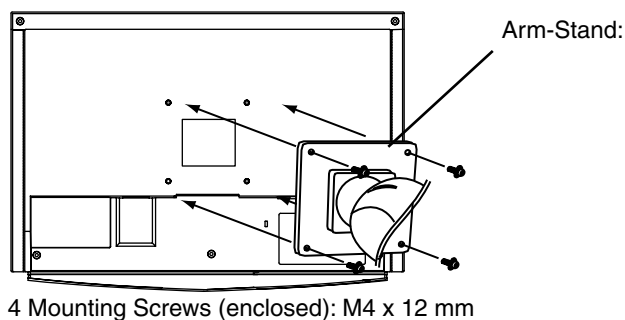

CE240W

- Hole spacing on the arm mounting: 100 mm x 100 mm (VESA compliant)

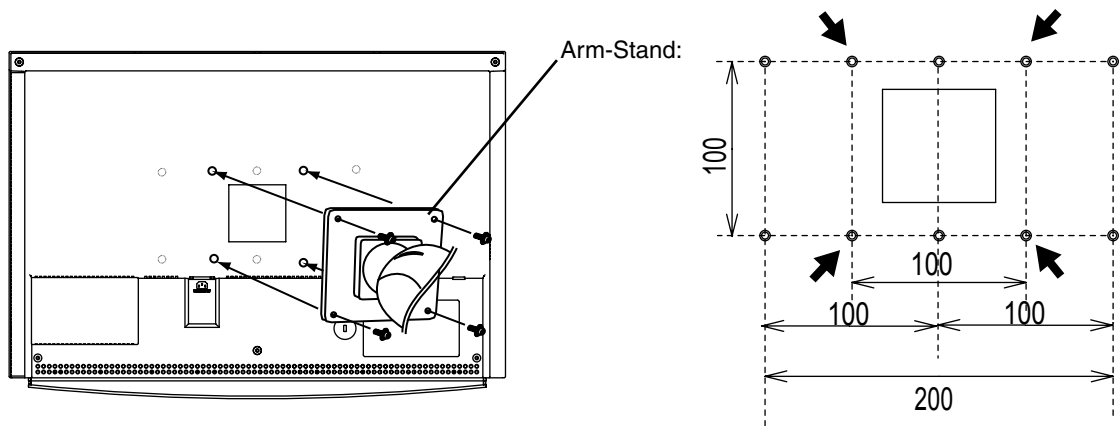

4 Mounting Screws (enclosed): M4 x 12 mm

- Hole spacing on the arm mounting: 200 mm x 100 mm (VESA compliant)

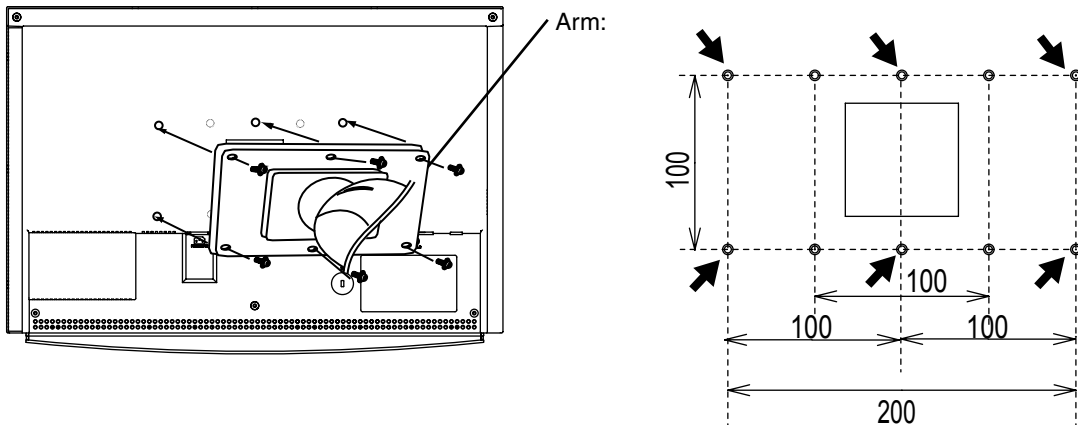





6 Mounting Screws (enclosed): M4 x 12 mm

7. TROUBLESHOOTING

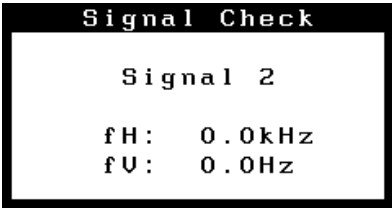
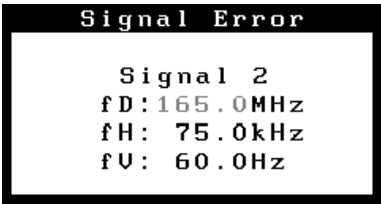
If a problem persists even after applying the suggested remedies, contact an EIZO dealer.

- No picture problems → See No.1 ~ No.2
- Imaging problems → See No.3 ~ No.14
- Other problems → See No.15 ~ No.18
- USB problems → See No.19 ~ No.20

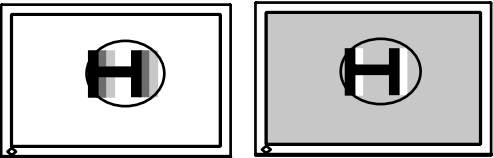
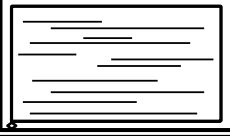
Problems	Points to check with Possible Solutions
1. No picture • Indicator status: Off	<ul style="list-style-type: none"> • Check that the power cord is correctly connected. If the problem persists, turn off the monitor power for a few minutes, then turn it back on and try again. • Try touching the Power switch.
• Indicator status: Blue	<ul style="list-style-type: none"> • Check the Gain setting (page 28).
• Indicator status: Orange	<ul style="list-style-type: none"> • Switch the signal input by touching the Input Signal Selection switch on the front control panel. • Try pressing a key on the keyboard, or clicking the mouse.
2. The error message below appears • This message appears when no signal is input. (This is displayed for about 40 seconds.) 	<p>These messages appear when the signal is not inputted correctly, even if the monitor functions properly.</p> <ul style="list-style-type: none"> • When the image is displayed correctly after a short time, there is no problem with the monitor. (Some PCs do not output the signal soon after powering on.) • Check that the PC is turned ON. • Check that the signal cable is properly connected to the PC or graphics board. • Switch the signal input by touching the Input Signal Selection switch on the control panel.
• The signal frequency is out of range. Error signal frequency will be displayed in red. (Example) 	<ul style="list-style-type: none"> • Use the graphics board's utility software to change the frequency setting. (Refer to the manual of the graphics board.)
3. Display position is incorrect. 	<ul style="list-style-type: none"> • Adjust the image position using the <Position> (page 24). • If the problem persists, use the graphics board's utility software to change the display position if available.
4. Screen image is smaller or larger than the actual screen images.	<ul style="list-style-type: none"> • Adjust the resolution using the <Resolution> (page 25).
5. Vertical bars of distortion appear. 	<ul style="list-style-type: none"> • Decrease the vertical bars using the <Clock> (page 24).

Problems	Points to check with Possible Solutions
<p>6. The characters and images have several vertical bars on their right side.</p> 	<ul style="list-style-type: none"> Adjust the characters and images using the <Signal Filter>.
<p>7. Horizontal bars of distortion appear.</p> 	<ul style="list-style-type: none"> Decrease the horizontal bars using the <Phase> (page 24).
<p>8. Letters and lines appear blurred.</p>	<ul style="list-style-type: none"> Adjust the blurred lines using <Smoothing> (page 26).
<p>9. Distortion appears like the figure below.</p> 	<ul style="list-style-type: none"> This happens when both composite (X-OR) input signal and separate vertical synchronizing signal are input. Please select one of the two.
<p>10. The screen is too bright or too dark.</p>	<ul style="list-style-type: none"> Adjust the <Brightness>. (The backlight of the LCD monitor has a fixed life span. When the screen becomes dark or begins to flicker, please contact your dealer.)
<p>11. Afterimages appear.</p>	<ul style="list-style-type: none"> Do you use the screen saver or timer when displaying the same image for extended periods of time? Afterimages are particular to LCD monitors. Avoid displaying the same image for extended periods of time.
<p>12. The screen has defective pixels (e.g. slightly light or dark).</p>	<ul style="list-style-type: none"> This is due to the characteristics of the panel itself, and not the LCD product.
<p>13. Fingerprints remain on the screen.</p>	<ul style="list-style-type: none"> Leave the monitor with a white screen or a black screen. The symptom may disappear.
<p>14. The noise appears on the screen.</p>	<ul style="list-style-type: none"> Change the mode in <Signal Filter> in the <Screen> menu. If the using graphics board supports digital connection, try using the monitor in the digital signal input.
<p>15. The <Smoothing> cannot be selected.</p>	<ul style="list-style-type: none"> <Smoothing> is disabled in the following cases. <ul style="list-style-type: none"> <CE210W> <ul style="list-style-type: none"> Screen is displayed in the 1680×1050 <CE240W> <ul style="list-style-type: none"> Screen is displayed in the 1920×1200 "Enlarged" is selected in <Screen Size> at 800 x 600 resolution. "Enlarged" is selected in <Screen Size> at 1600 x 1200 resolution. "Normal" is selected in <Screen Size>.
<p>16. The Main menu of ScreenManager does not operate.</p>	<ul style="list-style-type: none"> Check that there is nothing left on the face of Enter switch. Wipe the control panel, and then touch the Enter switch again with dry finger. The adjustment lock is probably on. To unlock: turn the LCD monitor off. Then, while touching the Auto Adjustment switch, turn the power on. Check that the FineContrast mode is not activated
<p>17. The FineContrast mode does not operate.</p>	<ul style="list-style-type: none"> Check that the Main menu of ScreenManager is not activated.

7. TROUBLESHOOTING

Problems	Points to check with Possible Solutions
18. The Auto adjustment switch does not operate.	<ul style="list-style-type: none">• Check that there is nothing left on the face of Auto Adjustment switch. Wipe the control panel, and then touch the Auto Adjustment switch again with dry finger.• The adjustment lock is probably on. To unlock: turn the LCD monitor off. Then, while touching the Auto Adjustment switch, turn the power on.
19. PC is hung up. / The peripherals connected to the downstream ports do not operate.	<ul style="list-style-type: none">• Check that the USB cable is correctly connected.• Check the downstream ports by connecting the peripherals to other downstream ports. If the problem is solved by doing this, contact an EIZO dealer. (For details, refer to the manual of the PC.)• Try executing the following method.<ul style="list-style-type: none">• Restarting the PC• Connecting the PC and peripherals directly <p>If the problem is solved by doing this, contact an EIZO dealer.</p>
20. USB function cannot be setup.	<ul style="list-style-type: none">• Check that the USB cable is correctly connected.• Check that the PC and OS are USB compliant. (For verification of USB support, consult the manufacturer of each system.)• Check the PC's BIOS setting for USB. (For details, refer to the manual of the PC.)

8. CLEANING

Periodic cleaning is recommended to keep the monitor looking new and to prolong its operation lifetime.

NOTE

- Never use thinner, benzene, alcohol (ethanol, methanol, or isopropyl alcohol), abrasive cleaners, or other strong solvents, as these may cause damage to the cabinet or LCD panel.
-

Cabinet

To remove stains, wipe the cabinet with a soft, lightly moistened cloth using a mild detergent. Do not spray wax or cleaner directly into the cabinet. (For details, refer to the manual of the PC.)

LCD Panel

- The LCD surface can be cleaned with a soft cloth, such as cotton or lens paper.
- If necessary, stubborn stains can be removed by moistening part of a cloth with water to enhance its cleaning power.

Tips

- Optional ScreenCleaner is recommended for cleaning the panel surface.
-

9. SPECIFICATIONS

CE210W

LCD Panel		53 cm (21.1 inch), TFT color LCD panel with Anti-Glare Hard Coating, Viewing Angle: Horizontal: 178°, Vertical: 178° (CR: 10 or more)
Dot Pitch		0.270mm
Horizontal Scan Frequency	Analog	24~82kHz (Automatic)
	Digital	31~65kHz
Vertical Scan Frequency	Analog	49~86Hz (Automatic) (1280 x 1024: 49 ~ 76 Hz / 1680 x 1050: 49 ~ 61 Hz)
	Digital	59 ~ 61 Hz (VGA TEXT: 69 ~ 71 Hz)
Resolution		1680 dots x 1050 lines
Dot Clock (Max.)	Analog	150MHz
	Digital	120MHz
Display Colors		16.77 million colors (max.)
Display Area		453.6 mm (H) x 283.5 mm (V) (17.9" (H) x 11.2" (V))
Power Supply		100-120/200-240 VAC±10%, 50/60 Hz, 0.8/0.45 A(with USB)
Power Consumption		Max. : 80 W (with USB) Max. (Normal) : 70W (without USB) Power Saving Mode : Less than 2 W (for single signal inputwithout USB)
Input Connector		DVI-Ix2
Analog Input Signal (Sync)		a)Separate, TTL, Positive/Negative b)Composite, TTL, Positive/Negative
Analog Input Signal (Video)		0.7 Vp-p / 75 ohms, Positive
Input Signal (Digital)		TMDS (Single Link)
Signal registration	Analog	45 (Factory preset: 24)
	Digital	10 (Factory preset: 0)
Plug & Play		VESA DDC 2B / EDID structure 1.3
Dimensions	with stand	501 mm (W) x 341.1~ 459.5 mm (H) x 230 mm (D) (19.7"(W) x 13.4" ~ 18.1" (H) x 9.1"(D))
	without stand	501mm (W) x 355 mm (H) x 85 mm (D) (19.7"(W) x 14.0"(H) x 3.35"(D))
Weight	with stand	8.2 kg (18.1 lbs.)
	without stand	5.8 kg (12.8 lbs.)
Temperature		Operating : 0°C ~ 35°C (32°F ~ 95°F) Storage : -20°C ~ 60°C (-4°F ~ 140°F) Humidity : 30% to 80% R.H. Non-condensing
USB	standard	USB Specification Revision 2.0
	USB port	Upstream port x 1 Downstream port x 2
	Communication Speed	480 Mbps (high), 12 Mbps (full), 1.5 Mbps (low)
	Power Supply	Downstream: 500 mA for each (max.)

CE240W

LCD Panel		61 cm (24.1 inch), TFT color LCD panel with Anti-Glare, Viewing Angle: Horizontal: 178°, Vertical: 178° (CR: 10 or more)
Dot Pitch		0.270mm
Horizontal Scan Frequency	Analog	24~94 kHz (Automatic)
	Digital	31~76 kHz
Vertical Scan Frequency	Analog	49~86Hz (Automatic) (1600 x 1200: 49 ~ 76 Hz / 1920 x 1200: 49 ~ 61 Hz)
	Digital	59 ~ 61 Hz (VGA TEXT: 69 ~ 71 Hz)
Resolution		1920 dots x 1200 lines
Dot Clock (Max.)	Analog	202.5MHz
	Digital	162MHz
Display Colors		16.77 million colors (max.)
Display Area		518.4 mm (H) x 324.0 mm (V) (20.4" (H) x 12.8" (V))
Power Supply		100-120/200-240 VAC±10%, 50/60 Hz, 1.1 A/0.55A (with USB)
Power Consumption		Max. : 110 W (with USB) Max. (Normal) : 100W (without USB) Power Saving Mode : Less than 2 W (for single signal inputwithout USB)
Input Connector		DVI-Ix2
Analog Input Signal (Sync)		a)Separate, TTL, Positive/Negative b)Composite, TTL, Positive/Negative
Analog Input Signal (Video)		0.7 Vp-p / 75 ohms, Positive
Input Signal (Digital)		TMDS (Single Link)
Signal registration	Analog	45 (Factory preset: 30)
	Digital	10 (Factory preset: 0)
Plug & Play		VESA DDC 2B / EDID structure 1.3
Dimensions	with stand	566 mm (W) x 358.7~ 480 mm (H) x 230 mm (D) (22.3"(W) x 14.1" ~ 18.9" (H) x 9.1"(D))
	without stand	566mm (W) x 396 mm (H) x 85 mm (D) (22.3"(W) x 15.6"(H) x 3.35"(D))
Weight	with stand	10.2 kg (22.5 lbs.)
	without stand	7.8 kg (17.2 lbs.)
Temperature		Operating : 0°C ~ 35°C (32°F ~ 95°F) Storage : -20°C ~ 60°C (-4°F ~ 140°F) Humidity : 30% to 80% R.H. Non-condensing
USB	standard	USB Specification Revision 2.0
	USB port	Upstream port x 1 Downstream port x 2
	Communication Speed	480 Mbps (high), 12 Mbps (full), 1.5 Mbps (low)
	Power Supply	Downstream: 500 mA for each (max.)

Default settings

Brightness	30%	
Smoothing	3	
Temperature	6500K	
FineContrast Mode	Custom	
PowerManager	Analog input : VESA DPMS Digital input: DVI DMPM	
Screen Size	Full	
Input Priority	1	
Off Timer	Disable	
Menu Settings	Menu Size	Normal
	Menu Off Timer	45 seconds
Beep	On	
Language	English	

Beeper settings

Short beep	ScreenManager item selected. ScreenManager parameter adjusted to minimum or maximum limit. Input Signal Selection Button pressed.
Long beep	Auto Adjustment Button pressed. ScreenManager data-save executed.
4 short beeps	Monitor not connected correctly. PC turned off. Monitor received unsupported signal frequency.
2 short beeps every 15 sec.	Monitor is in the advance notice mode of the Off Timer. The power will be off within fifteen minutes.

Dimensions

<CE210W>

mm (inch)

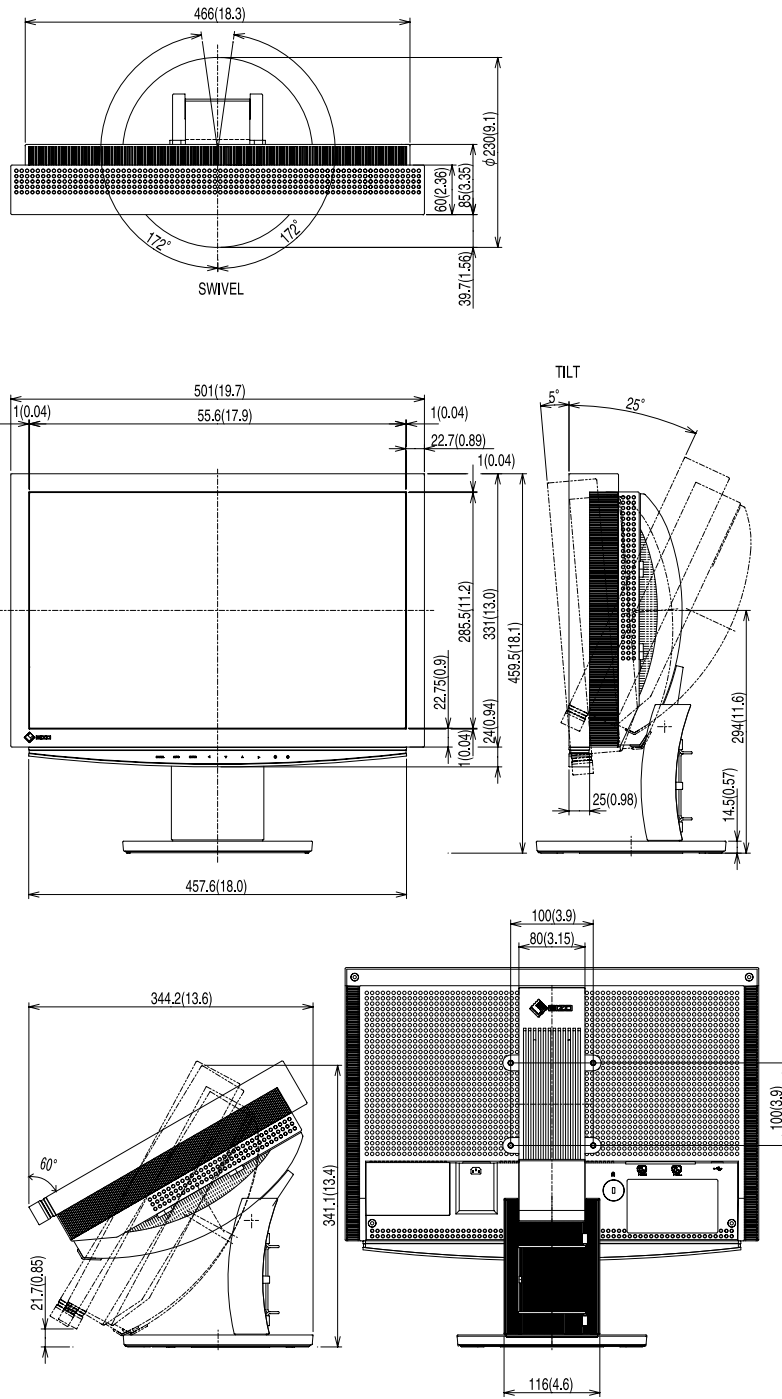

<CE240W>

mm (inch)

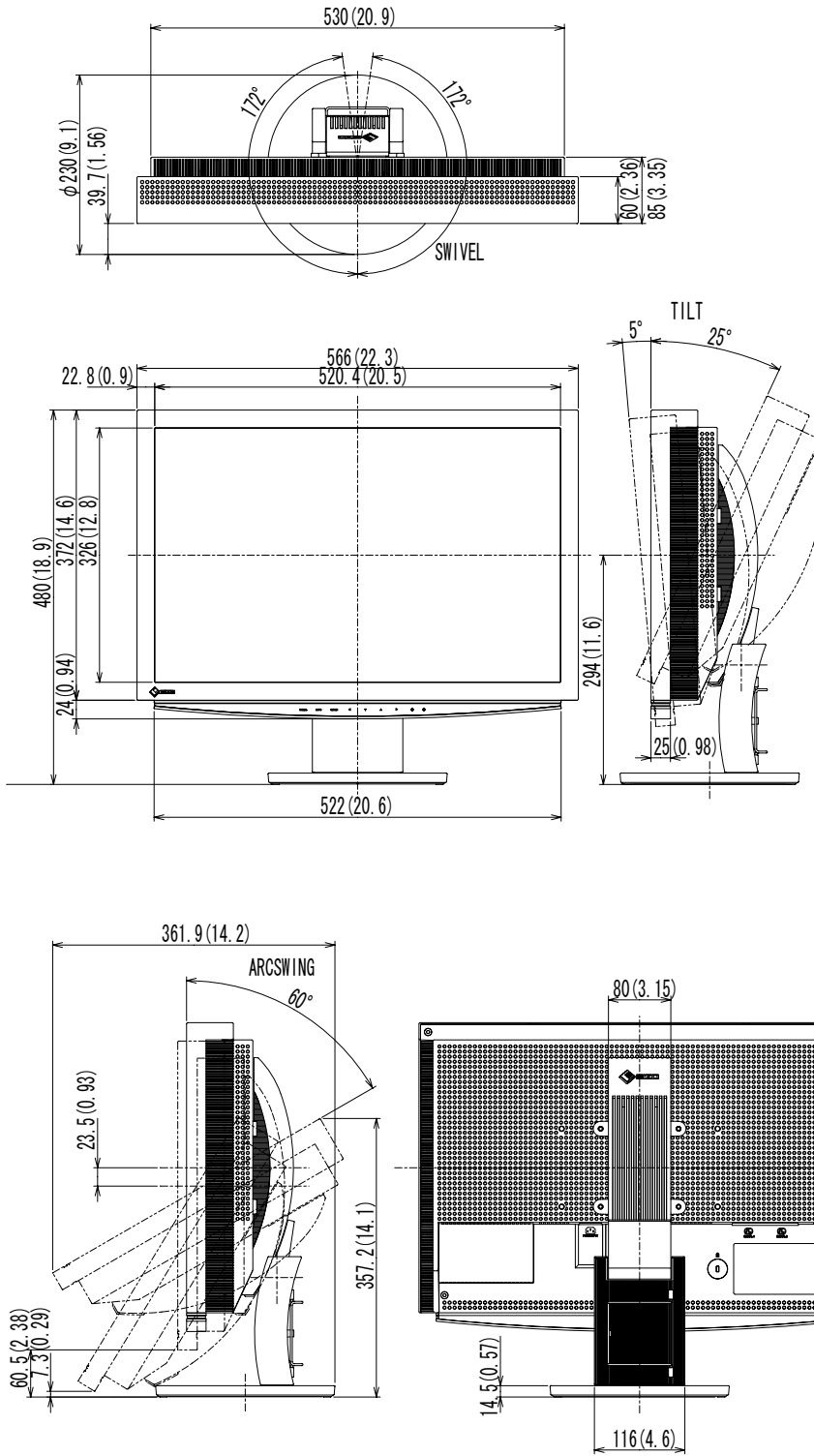

Pin Assignment

DVI-I Connector

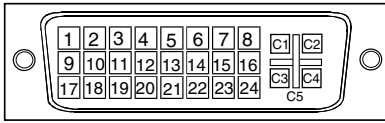

Pin No.	Signal	Pin No.	Signal	Pin No.	Signal
1	TMDS Data 2-	11	TMDS Data1/3 Shield	21	NC*
2	TMDS Data 2+	12	NC*	22	TMDS Clock shield
3	TMDS Data2/4 Shield	13	NC*	23	TMDS Clock+
4	NC*	14	+5V Power	24	TMDS Clock-
5	NC*	15	Ground (return for +5V, Hsync and Vsync)	C1	Analog Red
6	DDC Clock (SCL)	16	Hot Plug Detect	C2	Analog Green
7	DDC Data (SDA)	17	TMDS Data0-	C3	Analog Blue
8	Analog Vertical Sync	18	TMDS Data0+	C4	Analog Horizontal Sync
9	TMDSData1-	19	TMDS Data0/5 Shield	C5	Analog Ground(analog R,G,&B return)
10	TMDS Data1+	20	NC*		

(*NC: No Connection)

USB Port

Upstream

Downstream

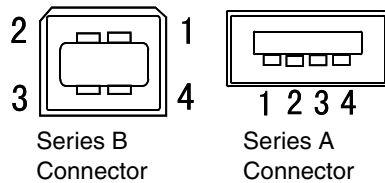

No.	Signal	Remarks
1	VCC	Cable power
2	- Data	Serial Data
3	+ Data	Serial Data
4	Ground	Cable Ground

10. GLOSSARY

Clock

With the analog input signal display, the analog signal is converted to a digital signal by the LCD circuitry. To convert the signal correctly, the LCD monitor needs to produce the same number clock pulse as the dot clock of the graphics system. When the clock pulse is not correctly set, some vertical bars of distortion are displayed on the screen.

DVI (Digital Visual Interface)

A digital flat panel interface. DVI can transmit digital data from the PC directly without loss with the signal transition method "TMDS". There are two kinds of DVI connectors. One is DVI-D connector for digital signal input only. The other is DVI-I connector for both digital and analog signal inputs.

DVI DMPM(DVI Digital Monitor Power Management)

The Power management system for the digital interface. The "Monitor ON" status (operation mode) and the "Active Off" status (power-saving mode) are indispensable for the DVI-DMPM as the monitor's power mode.

Gain Adjustment

Adjusts each color parameter for red, green and blue. The color of the LCD monitor is displayed through the color filter of the LCD panel. Red, green and blue are the three primary colors. The colors on the monitor are displayed by combining these three colors. The color tone can change by adjusting the illumination amount passed through each color's filter.

Gamma

Generally, the relationship that the light intensity values of a monitor change nonlinearly to the input signal level is called "Gamma Characteristic". On the monitor, low gamma values display the whitish images and high gamma values display the high contrast images.

Phase

The phase adjustment decides the sampling timing point for converting the analog input signal to a digital signal. Adjusting the phase after the clock adjustment will produce a clear screen.

Range Adjustment

The Range Adjustment controls the level of output signal range to display the whole color gradation.

Resolution

The LCD panel consists of a fixed number of pixel elements which are illuminated to form the screen image. The EIZO CE210W display panel consists of 1680 horizontal pixels and 1050 vertical pixels, and the EIZO CE240W display panel consists of 1920 horizontal pixels and 1200 vertical pixels. At a resolution of 1680 x 1050 (CE210W) / 1920 x 1200 (CE240W), all pixels are displayed as a full screen.

sRGB(Standard RGB)

"International Standard for Red, Green, and Blue color space" A color space was defined with the aim of the color matching between applications and hardware devices, such as monitors, scanners, printers and digital cameras. As a standard default space, sRGB allows Internet users to closely match colors.

Temperature

Color Temperature is a method to measure the white color tone, generally indicated in degrees Kelvin. At high temperatures the white tone appears somewhat blue, while at lower temperatures it appears somewhat red. Computer monitors generally give best performance at high temperature settings.

5000 K: Slightly reddish white.

6500 K: Warm-white tone, similar to white paper or daylight.

9300 K: Slightly bluish white.

TMDS(Transition Minimized Differential Signaling)

A signal transition method for the digital interface.

VESA DPMS**(Video Electronics Standards Association - Display Power Management Signaling)**

The acronym VESA stands for "Video Electronics Standards Association", and DPMS stands for "Display Power Management Signaling". DPMS is a communication standard that PCs and graphics boards use to implement power savings on the monitor side.

11. APPENDIX/ANHANG/ANNEXE

Preset Timing Chart for Analog input Timing-Übersichten für Analog Eingang Synchronisation des Signaux pour Analog numerique

NOTE

- Based on the signal diagram shown below factory presets have been registered in the monitor's microprocessor.
- Der integrierte Mikroprozessor des Monitors unterstützt werkseitige Standardeinstellungen (siehe hierzu die nachfolgenden Diagramme).
- Signaux ont été enregistrés en usine dans le microprocesseur du moniteur, conformément au diagramme de synchronisation ci-dessous.

CE210W

Mode	Dot Clock MHz		Frequencies		Sync Polarity
			Horizontal:kHz	Vertical:Hz	
VGA 640x480@60Hz	25.2 MHz	Horizontal	31.47	Negative	
		Vertical	59.94	Negative	
VGA TEXT 720x400@70Hz	28.3 MHz	Horizontal	31.47	Negative	
		Vertical	70.09	Positive	
Macintosh 640x480@67Hz	30.2 MHz	Horizontal	35.00	Negative	
		Vertical	66.67	Negative	
Macintosh 832x624@75Hz	57.3 MHz	Horizontal	49.73	Negative	
		Vertical	74.55	Negative	
Macintosh 1152x870@75Hz	100.0 MHz	Horizontal	68.68	Negative	
		Vertical	75.06	Negative	
Macintosh 1280x960@75Hz	126.2 MHz	Horizontal	74.76	Positive	
		Vertical	74.76	Positive	
VESA 640x480@72Hz	31.5 MHz	Horizontal	37.86	Negative	
		Vertical	72.81	Negative	
VESA 640x480@75Hz	31.5 MHz	Horizontal	37.50	Negative	
		Vertical	75.00	Negative	
VESA 640x480@85Hz	36.0 MHz	Horizontal	43.27	Negative	
		Vertical	85.01	Negative	
VESA 800x600@56Hz	36.0 MHz	Horizontal	35.16	Positive	
		Vertical	56.25	Positive	
VESA 800x600@60Hz	40.0 MHz	Horizontal	37.88	Positive	
		Vertical	60.32	Positive	
VESA 800x600@72Hz	50.0 MHz	Horizontal	48.08	Positive	
		Vertical	72.19	Positive	
VESA 800x600@75Hz	49.5 MHz	Horizontal	46.88	Positive	
		Vertical	75.00	Positive	
VESA 800x600@85Hz	56.3 MHz	Horizontal	53.67	Positive	
		Vertical	85.06	Positive	
VESA 1024x768@60Hz	65.0 MHz	Horizontal	48.36	Negative	
		Vertical	60.00	Negative	
VESA 1024x768@70Hz	75.0 MHz	Horizontal	56.48	Negative	
		Vertical	70.07	Negative	
VESA 1024x768@75Hz	78.8 MHz	Horizontal	60.02	Positive	
		Vertical	75.03	Positive	
VESA 1024x768@85Hz	94.5 MHz	Horizontal	68.68	Positive	
		Vertical	85.00	Positive	
VESA 1152x864@75Hz	108.0 MHz	Horizontal	67.50	Positive	
		Vertical	75.00	Positive	
VESA 1280x960@60Hz	108.0 MHz	Horizontal	60.00	Positive	
		Vertical	60.00	Positive	
VESA 1280x1024@60Hz	108.0 MHz	Horizontal	63.98	Positive	
		Vertical	60.02	Positive	
VESA 1280x1024@75Hz	135.0 MHz	Horizontal	79.98	Positive	
		Vertical	75.03	Positive	
VESA CVT 1680x1050 60Hz	146.3 MHz	Horizontal	65.29	Negative	
		Vertical	59.95	Positive	
VESA CVT RB 1680x1050 60Hz	119.0 MHz	Horizontal	64.67	Positive	
		Vertical	59.88	Negative	

CE240W

Mode	Dot Clock MHz		Frequencies		Sync Polarity
			Horizontal:kHz	Vertical:Hz	
VGA 640×480 @60Hz	25.2 MHz	Horizontal	31.47	Negative	
		Vertical	59.94	Negative	
VGA TEXT 720×400 @70Hz	28.3 MHz	Horizontal	31.47	Negative	
		Vertical	70.09	Positive	
Macintosh 640×480 @67Hz	30.2 MHz	Horizontal	35.00	Negative	
		Vertical	66.67	Negative	
Macintosh 832×624 @75Hz	57.3 MHz	Horizontal	49.73	Negative	
		Vertical	74.55	Negative	
Macintosh 1152×870 @75Hz	100.0 MHz	Horizontal	68.68	Negative	
		Vertical	75.06	Negative	
Macintosh 1280×960 @75Hz	126.2 MHz	Horizontal	74.76	Positive	
		Vertical	74.76	Positive	
VESA 640×480 @72Hz	31.5 MHz	Horizontal	37.86	Negative	
		Vertical	72.81	Negative	
VESA 640×480 @75Hz	31.5 MHz	Horizontal	37.50	Negative	
		Vertical	75.00	Negative	
VESA 640×480 @85Hz	36.0 MHz	Horizontal	43.27	Negative	
		Vertical	85.01	Negative	
VESA 800×600 @56Hz	36.0 MHz	Horizontal	35.16	Positive	
		Vertical	56.25	Positive	
VESA 800×600 @60Hz	40.0 MHz	Horizontal	37.88	Positive	
		Vertical	60.32	Positive	
VESA 800×600 @72Hz	50.0 MHz	Horizontal	48.08	Positive	
		Vertical	72.19	Positive	
VESA 800×600 @75Hz	49.5 MHz	Horizontal	46.88	Positive	
		Vertical	75.00	Positive	
VESA 800×600 @85Hz	56.3 MHz	Horizontal	53.67	Positive	
		Vertical	85.06	Positive	
VESA 1024×768 @60Hz	65.0 MHz	Horizontal	48.36	Negative	
		Vertical	60.00	Negative	
VESA 1024×768 @70Hz	75.0 MHz	Horizontal	56.48	Negative	
		Vertical	70.07	Negative	
VESA 1024×768 @75Hz	78.8 MHz	Horizontal	60.02	Positive	
		Vertical	75.03	Positive	
VESA 1024×768 @85Hz	94.5 MHz	Horizontal	68.68	Positive	
		Vertical	85.00	Positive	
VESA 1152×864 @75Hz	108.0 MHz	Horizontal	67.50	Positive	
		Vertical	75.00	Positive	
VESA 1280×960 @60Hz	108.0 MHz	Horizontal	60.00	Positive	
		Vertical	60.00	Positive	
VESA 1280×1024 @60Hz	108.0 MHz	Horizontal	63.98	Positive	
		Vertical	60.02	Positive	
VESA 1280×1024 @75Hz	135.0 MHz	Horizontal	79.98	Positive	
		Vertical	75.03	Positive	
VESA 1280×1024 @85Hz	157.5 MHz	Horizontal	91.15	Positive	
		Vertical	85.03	Positive	
VESA 1600×1200 @60Hz	162.0 MHz	Horizontal	75.00	Positive	
		Vertical	60.00	Positive	
VESA 1600×1200 @65Hz	175.0 MHz	Horizontal	81.30	Positive	
		Vertical	65.00	Positive	
VESA 1600×1200 @70Hz	189.0 MHz	Horizontal	87.50	Positive	
		Vertical	70.00	Positive	
VESA 1600×1200 @75Hz	202.5 MHz	Horizontal	93.75	Positive	
		Vertical	75.00	Positive	
VESA CVT 1680×1050 60Hz	146.3 MHz	Horizontal	65.29	Negative	
		Vertical	59.95	Positive	
VESA CVT 1920×1200 60Hz	193.3 MHz	Horizontal	74.56	Negative	
		Vertical	59.89	Positive	
VESA CVT RB 1920×1200 60Hz	154.0 MHz	Horizontal	74.04	Positive	
		Vertical	59.95	Negative	



Congratulations!

The display you have just purchased carries the TCO'03 Displays label. This means that your display is designed, manufactured and tested according to some of the strictest quality and environmental requirements in the world. This makes for a high performance product, designed with the user in focus that also minimizes the Impact on our natural environment.

Some of the features of the TCO'03 Display requirements:

Ergonomics

- Good visual ergonomics and image quality in order to improve the working environment for the user and to reduce sight and strain problems. Important parameters are luminance, contrast, resolution, reflectance, colour rendition and image stability.

Energy

- Energy-saving mode after a certain time - beneficial both for the user and environment
- Electrical safety

Emissions

- Electromagnetic fields
- Noise emissions

Ecology

- The products must be prepared for recycling and the manufacturer must have a certified environmental management system such as EMAS or ISO 14000
- Restrictions on
 - chlorinated and brominated flame retardants and polymers
 - heavy metals such as cadmium, mercury and lead.

The requirements included in this label have been developed by TCO Development in co-operation with scientists, experts, users as well as manufacturers all over the world. Since the end of the 1980s TCO has been involved in influencing the development of IT equipment in a more user-friendly direction. Our labeling system with displays in 1992 and is now requested by users and IT-manufacturers all over the world.

**For more information, please visit
www.tcodevelopment.com**

For U.S.A. , Canada, etc. (rated 100-120 Vac) Only

FCC Declaration of Conformity

We, the Responsible Party

EIZO NANAOTECHNOLOGIES INC.

5710 Warland Drive, Cypress, CA 90630

Phone: (562) 431-5011

declare that the product

Trade name: EIZO

Model: ColorEdge CE210W/CE240W

is in conformity with Part 15 of the FCC Rules. Operation of this product is subject to the following two conditions: (1) this device may not cause harmful interference, and (2) this device must accept any interference received, including interference that may cause undesired operation.

This equipment has been tested and found to comply with the limits for a Class B digital device, pursuant to Part 15 of the FCC Rules. These limits are designed to provide reasonable protection against harmful interference in a residential installation. This equipment generates, uses, and can radiate radio frequency energy and, if not installed and used in accordance with the instructions, may cause harmful interference to radio communications. However, there is no guarantee that interference will not occur in a particular installation. If this equipment does cause harmful interference to radio or television reception, which can be determined by turning the equipment off and on, the user is encouraged to try to correct the interference by one or more of the following measures.

- * Reorient or relocate the receiving antenna.
- * Increase the separation between the equipment and receiver.
- * Connect the equipment into an outlet on a circuit different from that to which the receiver is connected.
- * Consult the dealer or an experienced radio/TV technician for help.

Changes or modifications not expressly approved by the party responsible for compliance could void the user's authority to operate the equipment.

Note

Use the attached specified cable below or EIZO signal cable with this monitor so as to keep interference within the limits of a Class B digital device.

- AC Cord
- Shielded Signal Cable (Enclosed)

Canadian Notice

This Class B digital apparatus complies with Canadian ICES-003.

Cet appareil numérique de la classe B est conforme à la norme NMB-003 du Canada.

Hinweise zur Auswahl des richtigen Schwenkarms für Ihren Monitor

Dieser Monitor ist für Bildschirmarbeitsplätze vorgesehen. Wenn nicht der zum Standardzubehör gehörige Schwenkarm verwendet wird, muss statt dessen ein geeigneter anderer Schwenkarm installiert werden. Bei der Auswahl des Schwenkarms sind die nachstehenden Hinweise zu berücksichtigen:

Der Standfuß muß den nachfolgenden Anforderungen entsprechen:

- a) Der Standfuß muß eine ausreichende mechanische Stabilität zur Aufnahme des Gewichtes vom Bildschirmgerät und des spezifizierten Zubehörs besitzen. Das Gewicht des Bildschirmgerätes und des Zubehörs sind in der zugehörenden Bedienungsanleitung angegeben.
- b) Die Befestigung des Standfusses muß derart erfolgen, daß die oberste Zeile der Bildschirmanzeige nicht höher als die Augenhöhe eines Benutzers in sitzender Position ist.
- c) Im Fall eines stehenden Benutzers muß die Befestigung des Bildschirmgerätes derart erfolgen, daß die Höhe der Bildschirmmitte über dem Boden zwischen 135 – 150 cm beträgt.
- d) Der Standfuß muß die Möglichkeit zur Neigung des Bildschirmgerätes besitzen (max. vorwärts: 5°, min. nach hinten $\geq 5^\circ$).
- e) Der Standfuß muß die Möglichkeit zur Drehung des Bildschirmgerätes besitzen (max. $\pm 180^\circ$). Der maximale Kraftaufwand dafür muß weniger als 100 N betragen.
- f) Der Standfuß muß in der Stellung verharren, in die er manuell bewegt wurde.
- g) Der Glanzgrad des Standfusses muß weniger als 20 Glanzeinheiten betragen (seidenmatt).
- h) Der Standfuß mit Bildschirmgerät muß bei einer Neigung von bis zu 10° aus der normalen aufrechten Position kippstabil sein.

Hinweis zur Ergonomie :

Dieser Monitor erfüllt die Anforderungen an die Ergonomie nach ISO13406-2 mit dem Videosignal, 1920 Punkte x 1200 Zeilen (CE240W)/1680 Punkte x 1050 Zeilen (CE210W), RGB analog, 0,7 Vp-p und mindestens 60,0 Hz Bildwiederholfrequenz, non interlaced. Weiterhin wird aus ergonomischen Gründen empfohlen, die Grundfarbe Blau nicht auf dunklem Untergrund zu verwenden (schlechte Erkennbarkeit, Augenbelastung bei zu geringem Zeichenkontrast.)

„Maschinenlärminformations-Verordnung 3. GPSGV:

Der höchste Schalldruckpegel beträgt 70 dB(A) oder weniger gemäss EN ISO 7779“

Recycle Auskunft

Die Rücknahme dieses Produktes nach Nutzungsende übernimmt EIZO in Deutschland zusammen mit dem Partner eds-r gmbh rucknahmesysteme. Dort werden die Geräte in ihre Bestandteile zerlegt, die dann der Wiederverwertung zugeführt werden. Um einen Abholtermin zu vereinbaren und die aktuellen Kosten zu erfahren, benutzen Sie bitte folgende Rufnummer: 02153-73 35 00. Weitere Informationen finden Sie auch unter der Internet-Adresse: www.eizo.de.

Recycling Information for customers in Switzerland:

All recycling information is placed in the SWICO's website.
<http://www.swico.ch>

Recycling-Information für Kunden in der Schweiz:

Alle Informationen zum Thema Recycling finden Sie auf der Homepage des Branchenverbandes SWICO.
<http://www.swico.ch>

Renseignements de recyclage pour les clients en Suisse:

Vous trouvez tous les renseignements pour le sujet de recyclage sur la page WEB de l'UNION DE BRAN CHE SWICO.
<http://www.swico.ch>

Recycling Information for customers in USA:

All recycling information is placed in the EIZO Nanao Technologies, Inc's website.
<http://www.eizo.com>

Återvinnings information för kunder i Sverige:

All information om återvinning finns på Eizo Europe AB:s hemsida:
www.eizo.se



EIZO NANAo CORPORATION

153 Shimokashiwano, Hakusan, Ishikawa 924-8566 Japan
Phone: +81 76 277 6792 Fax: +81 76 277 6793

EIZO NANAo TECHNOLOGIES INC.

5710 Warland Drive, Cypress, CA 90630, U.S.A.
Phone: +1 562 431 5011 Fax: +1 562 431 4811

EIZO EUROPE AB

Lovangsvagen 14 194 61, Upplands Väsby, Sweden
Phone: +46 8 590 80 000 Fax: +46 8 590 91 575

EIZO NANAo AG

Moosacherstrasse 6, Au CH - 8820 Wädenswil, Switzerland
Phone: +41-0-44 782 24 40 Fax: +41-0-44 782 24 50

Avnet Technology Solutions GmbH

Lötscher Weg 66, D-41334 Nettetal, Germany
Phone: +49 2153 733-400 Fax: +49 2153 733-483

<http://www.eizo.com>



4th Edition-May, 2007

03V21775D1
(U.M-CE210W-E)