

User's Manual

ColorEdge® CG319X

Color Management LCD Monitor

Thank you for purchasing our Color Management LCD Monitor.

Important

Please read this "User's Manual", and "PRECAUTIONS" (separate volume) carefully to familiarize yourself with safe and effective usage.

-
- Refer to the "Setup Guide" for information on the installation / connection of the monitor.
 - For the latest product information including the "User's Manual", refer to our web site :
www.eizoglobal.com
-



Location of Caution Statement

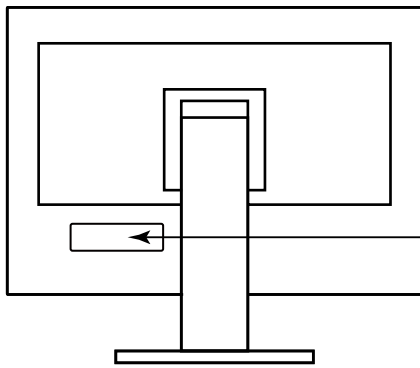

WARNING
RISK OF ELECTRIC SHOCK. DO NOT OPEN.
AVERTISSEMENT
RISQUE DE CHOC ÉLECTRIQUE. NE PAS OUVRIR.
WARNUNG
GEFAHR DES ELEKTRISCHEN SCHLAGES. RÜCKWAND NICHT ENTFERNEN.
警告
触电危険，请勿打开后盖。
警告
感電の恐れあり，カバーをあけないでください。

The equipment must be connected to a grounded main outlet.
L'appareil doit être relié à une prise avec terre.
Jordet stikkontakt skal benyttes når apparatet tilkobles datanett.
Apparaten skall anslutas till jordat nätuttag.
设备必须连接到接地式的电源插座。
電源コードのアースは必ず接地してください。

This product has been adjusted specifically for use in the region to which it was originally shipped. If operated outside this region, the product may not perform as stated in the specifications.

No part of this manual may be reproduced, stored in a retrieval system, or transmitted, in any form or by any means, electronic, mechanical, or otherwise, without the prior written permission of EIZO Corporation. EIZO Corporation is under no obligation to hold any submitted material or information confidential unless prior arrangements are made pursuant to EIZO Corporation's receipt of said information. Although every effort has been made to ensure that this manual provides up-to-date information, please note that EIZO monitor specifications are subject to change without notice.

Notice for This Monitor

About the Usage of This Product

This product is suited for producing videos, where accurate color reproduction is a priority.

This product has been adjusted specifically for use in the region to which it was originally shipped. If the product is used outside the region, it may not operate as specified in the specifications.

This product may not be covered by warranty for uses other than those described in this manual.

The specifications noted in this manual are only applicable when the following are used:

- Power cords provided with the product
 - Signal cables specified by us
-

Only use optional products manufactured or specified by us with this product.

About the LCD Panel

The LCD panel is manufactured using high-precision technology. Although, missing pixels or lit pixels may appear on the LCD panel, this is not a malfunction. Percentage of effective dots: 99.9994 % or higher.

It takes about 3 minutes (under our measurement conditions) for the monitor display to stabilize. Please wait 3 minutes or more after the monitor power has been turned on, and then adjust the monitor.

Monitors should be set to a lower brightness to prevent a loss in the screen quality caused by long-term use and to maintain stable use.

When the screen image is changed after displaying the same image for extended periods of time, an afterimage may appear. Use the screen saver or power save function to avoid displaying the same image for extended periods of time. Depending on the image, an afterimage may appear even if it was displayed for a short period of time. To remove such a phenomenon, change the image or keep the power turned off for several hours.

If the monitor displays continuously over a long period of time, smudges or burn-in may appear. To maximize the life of the monitor, we recommend the monitor be turned off periodically. Use the power switch on the front of the monitor to turn it off.

The backlight of the LCD panel has a fixed lifetime. Depending on the usage pattern, such as usage for long continuous periods, the lifespan of the backlight may run out sooner, requiring replacement. When the screen becomes dark or begins to flicker, please contact your local EIZO representative.

Do not press on the LCD panel or edge of the frame strongly, as this may result in display malfunctions, such as interference patterns, etc. If pressure is continuously applied to the LCD panel surface, the liquid crystal may deteriorate or the LCD panel may be damaged. (If the pressure marks remain on the panel, leave the monitor with a black or white screen. The symptom may disappear.)

Do not scratch or press on the LCD panel with any sharp objects, as this may result in damage to the LCD panel. Do not attempt to brush with tissues as this may scratch the panel.

About the Installation

When the monitor is cold and brought into a room or the room temperature goes up quickly, dew condensation may occur on the interior and exterior surfaces of the monitor. In that case, do not turn the monitor on. Instead wait until the dew condensation disappears, otherwise it may cause some damage to the monitor.

If you place this product on a lacquer-coated desk, the color may adhere to the bottom of the stand due to the composition of the rubber. Check the desk surface before use.

About the Maintenance

Periodic cleaning is recommended to keep the monitor looking new and to prolong its operation lifetime.

Cleaning

The stains on the cabinet and LCD panel surface can be removed by using the provided ScreenCleaner.

Attention

- Chemicals such as alcohol and antiseptic solution may cause gloss variation, tarnishing, and fading of the cabinet or LCD panel, and also quality deterioration of the image.
 - Never use thinner, benzine, wax, or abrasive cleaner as they may damage the cabinet or LCD panel surface.
-

To Use the Monitor Comfortably

- An excessively dark or bright screen may affect your eyes. Adjust the brightness of the monitor according to the environmental conditions.
- Staring at the monitor for a long time tires your eyes. Take a 10-minute rest every hour.

Contents

Notice for This Monitor	3	Chapter 5 Advanced Adjustments/Settings ... 22	
Cleaning	4	5-1. Basic Operation of the Setting Menu 22	
To Use the Monitor Comfortably	4	5-2. Setting Menu Functions	23
Contents	5	● Signal	23
Chapter 1 Introduction	6	● Color.....	25
1-1. Features	6	● SelfCalibration.....	30
● Large built-in high resolution 4K LCD that is advantageous for video production.....	6	● Screen.....	31
● Support for HDR (High Dynamic Range) video.....	6	● Preferences.....	36
● User-defined custom key function.....	6	● Languages	38
● SelfCalibration function.....	7	● Information	38
1-2. Controls and Functions	8	Chapter 6 Administrator Settings	39
● Front	8	6-1. Basic Operation of the "Administrator Settings" Menu.....	39
● Rear.....	9	6-2. "Administrator Settings" Menu Functions	40
1-3. Changing the Computer Display Settings ...	10	Chapter 7 Troubleshooting	42
● Windows 10.....	10	7-1. No Picture	42
● Windows 8.1 / Windows 7	10	7-2. Imaging Problems.....	43
● mac OS	10	7-3. SelfCalibration Problems.....	44
Chapter 2 Basic Adjustments/Settings	11	7-4. Other Problems	45
2-1. Switch Operation Method	11	Chapter 8 Reference	46
● Operation Guide Icons	11	8-1. Removing the Stand	46
2-2. Switching Input Signals	12	8-2. Attaching the Optional Arm.....	47
2-3. Switching the Display Mode (color mode)...	12	8-3. Attaching/Detaching the Cable Holder	48
● Display Modes.....	12	8-4. Connecting Multiple External Devices.....	50
● Color Mode Setting Values	13	8-5. Making Use of the USB Hub Function	51
Chapter 3 SelfCalibration	14	● Connection Procedure	51
● SelfCalibration functions	15	8-6. Specifications	53
3-1. Setting targets.....	17	● Accessories.....	54
3-2. Executing	17	Appendix	55
● Executing regardless of a schedule.....	17	Trademark	55
● Executing by setting a schedule	17	License	55
● Activating SelfCalibration in Standard Mode...	17	FCC Declaration of Conformity	56
● Activating SelfCalibration in Calibration Mode (CAL mode).....	18		
3-3. Checking results	18		
Chapter 4 Custom Key Settings	19		
4-1. Basic Operation of the Custom Keys	19		
4-2. Assigning a Function to a Custom Key.....	19		
● Functions that can be Assigned to Custom Keys	21		

Chapter 1 Introduction

This chapter describes the features of the monitor and the name of each control.

1-1. Features

● Large built-in high resolution 4K LCD that is advantageous for video production

- 31.1-inch widescreen monitor with support for DCI 4K resolution (4096 × 2160)
Supports the digital cinema standard for DCI 4K resolution of 4096 × 2160. In addition to 4K videos, which have a high resolution that is more than 4x greater than full HD, multiple full HD videos can be displayed at the same time.
- Faithful reproduction of video colors with a wide color gamut display
98 % of DCI is covered, for a highly accurate color management environment.
- Built-in IPS LCD panel with 178° horizontal and vertical wide viewing angles

● Support for HDR (High Dynamic Range) video

- Complies with the international HDR standards for movies and broadcasts
Supports both the HDR "PQ format" for streaming and movie production, and the HDR "Hybrid Log Gamma format" for broadcasts. The "PQ format" complies with the ITU-R BT.2100^{*1} and SMPTE ST2084^{*2} international HDR standards, and the "Hybrid Log Gamma format" complies with the ITU-R BT.2100 international HDR standard. This makes it possible to use the monitor for the creation of a wide range of HDR content, such as movies and broadcasts.
^{*1} ITU-R is the International Telecommunication Union-Radio communication Sector.
^{*2} SMPTE is the Society of Motion Picture and Television Engineers.
- Built-in color mode function
Reproduces a color temperature, gamma, and color gamut compliant with ITU-R BT.2100 and other standards.
See ["Color Mode" \(page 25\)](#)

● User-defined custom key function

- Work efficiency can be improved by assigning frequently used functions to the switches on the front of the monitor. The functions that can be assigned to custom keys are the following:
 - Input range
 - Zoom
 - BT.709 Gamut Warning
 - Luminance Warning
 - Safe Area Marker
 - Aspect Marker
 - Prev. Color Mode
 - Information
- See ["Chapter 4 Custom Key Settings" \(page 19\)](#)

● SelfCalibration function

- The built-in calibration sensor enables the monitor to calibrate itself by using SelfCalibration. By setting the calibration targets and execution schedule in advance, the calibration sensor automatically operates and regularly calibrates the monitor. This function can be used with Color Management Software "ColorNavigator 6" or "ColorNavigator NX" to calibrate monitor characteristics and generate color profiles.

You can set the calibration targets and execution schedule by using software (ColorNavigator 6 or ColorNavigator NX) or the monitor's Setting menu.

You can check for the result of the SelfCalibration adjustment by using the monitor's Color menu.

See "[Chapter 3 SelfCalibration](#)" (page 14)



Attention

Be careful of the following points when using the built-in calibration sensor.



Do not touch the built-in calibration sensor.

It may reduce the measurement accuracy of the built-in calibration sensor, or result in injury or equipment damage.

Attention

- A high temperature or high humidity environment may affect the measurement accuracy of the built-in calibration sensor.
Avoid storing or using the sensor where it may be exposed to direct sunlight.
 - Since the measurement result for the built-in calibration sensor may be affected, ensure that the level of ambient light that enters the receiver part of the built-in calibration sensor does not change significantly during measuring.
 - The use of a monitor hood is recommended.
 - While measuring, do not bring your face or any objects close to the monitor, do not look into the sensor.
 - Set the monitor in the environment so that external light does not enter the sensor directly.
-
-

1-2. Controls and Functions

● Front

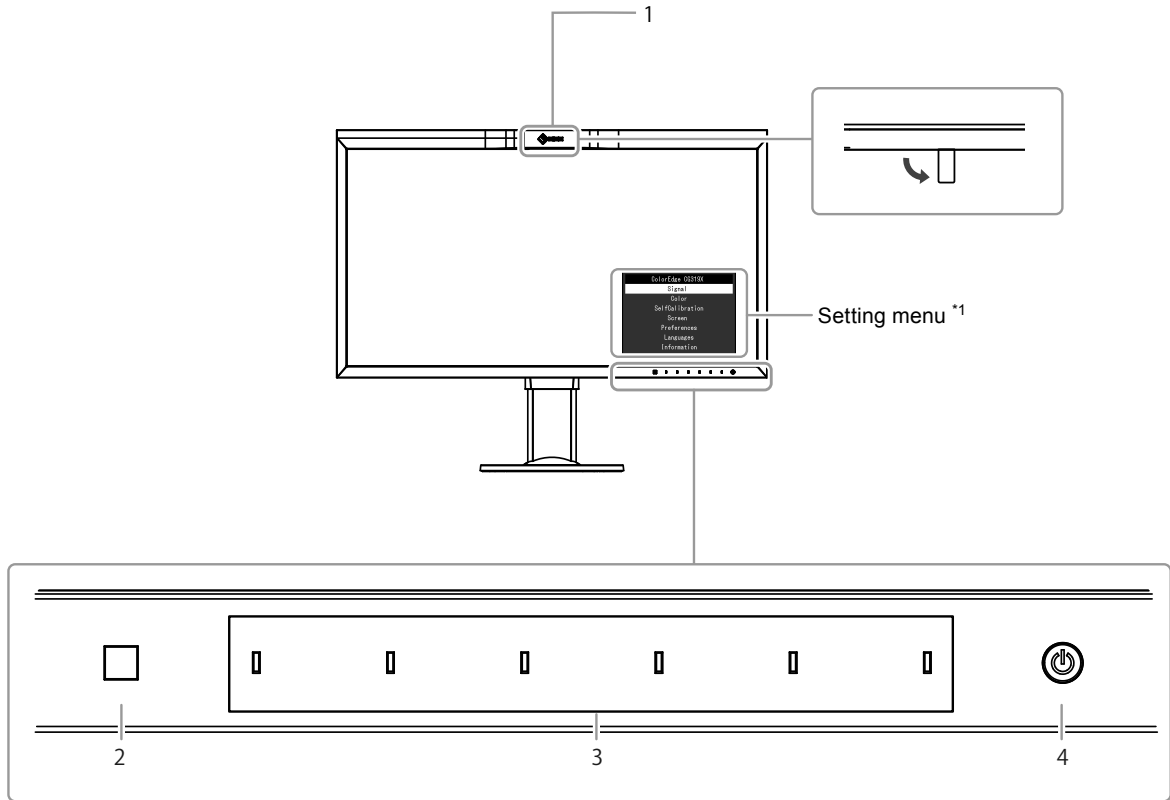

1. Built-in calibration sensor	Executes calibration for monitors. (SelfCalibration function)
2. Ambient light sensor	Measures ambient light.
3. Operation switches	Displays menus. Operate the switches according to the operation guide. Touch the switch to display its menu. The switch indicators are lit white when you turn on the power.
4. Power switch	Turns the power on or off. Touch the switch to turn the power on. The switch indicator is lit when you turn the power on. The indicator color differs depending on the monitor's operation status. White : Normal operation mode Orange : Power saving mode OFF : Power off

*1 See "5-1. Basic Operation of the Setting Menu" (page 22) for more information about how to use the Setting menu.

● Rear

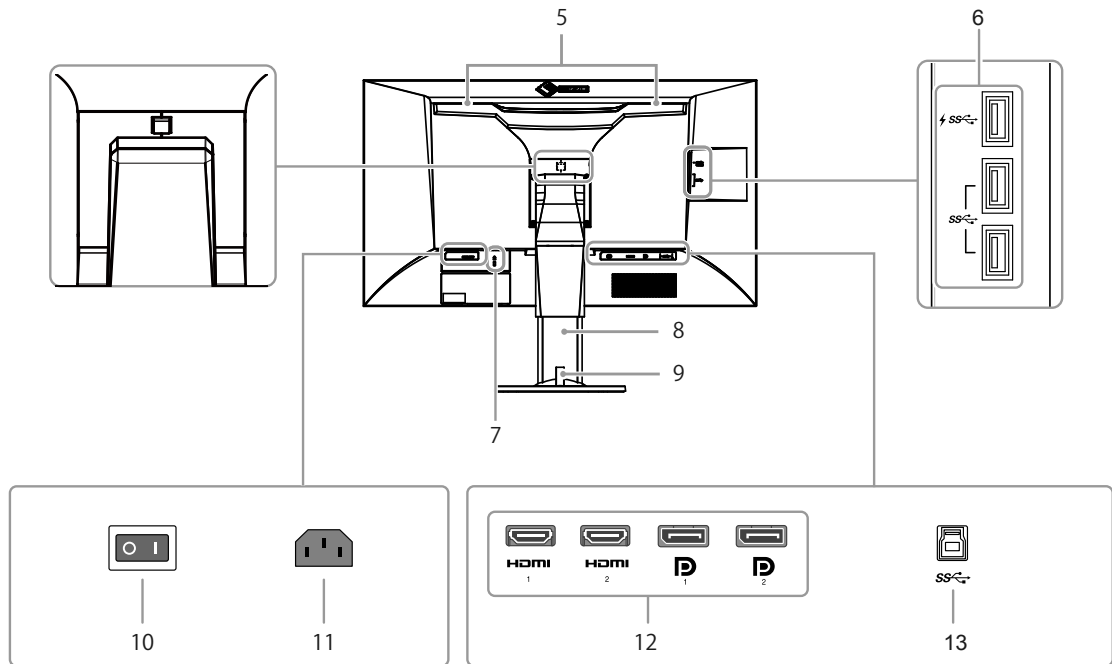

5. Transportation handle	This handle is used for transportation. Attention <ul style="list-style-type: none"> Firmly grasp and hold the monitor by the bottom while grabbing the handle, and carefully convey the monitor so as not to drop it. Do not hold the sensor section on the front side of the monitor.
6. USB downstream port	Connects to a peripheral USB device. ⚡ SS-C port supports quick recharging.
7. Security lock slot	Complies with Kensington's MicroSaver security system.
8. Stand^{*2}	Adjusts the height and angle (tilt and swivel) of the monitor.
9. Cable holder	Covers the monitor cables.
10. Main power switch	Turns the main power on or off. : On, ○ : Off
11. Power connector	Connects the power cord.
12. Input signal connectors	The following input connectors are located on the monitor rear in order of left to right. HDMI connector 1 HDMI connector 2 DisplayPort connector 1 DisplayPort connector 2
13. USB upstream port	Connects to the USB cable when using software that requires a USB connection, or when using the USB Hub function.

*2 An optional arm (or an optional stand) can be attached by removing the stand section.

1-3. Changing the Computer Display Settings

If the image is not displayed properly after connecting the monitor to a PC, follow the procedure below to change the display settings on the computer.

● Windows 10

1. Right-click the mouse anywhere on the desktop except on icons. A menu is displayed.
2. From the displayed menu, click “Display Settings”. The “Settings” screen is displayed.
3. If multiple monitors, including notebook PC screens, are connected to the computer, select “Extend these displays” in the “Multiple displays” menu, and then click “Keep changes” on the confirmation screen. After changing the settings, select a monitor in the “Select and rearrange displays” menu.
4. Select the “Make this my main display” option in the “Multiple displays” menu. This enables the monitor to display images properly.
5. Confirm that the recommended resolution for the monitor is set in the “Resolution” menu. (“(Recommended)” is displayed after the resolution.)
6. To change the size of text and icons, select a magnification in the menu of zoom percentages according to personal preference.
7. If a message prompting you to sign out is displayed after changing the settings, sign out and then sign in again.

● Windows 8.1 / Windows 7

* For Windows 8.1, click the “Desktop” tile on the Start Screen to display the desktop.

1. Right-click the mouse anywhere on the desktop except on icons. A menu is displayed.
2. From the displayed menu, click “Screen resolution”. The settings screen is displayed.
3. If multiple monitors, including notebook PC screens, are connected to the computer, select “Extend these displays” in the “Multiple displays” menu, and then click “Apply”. Click “Keep changes” on the confirmation screen.
4. Select a monitor in the “Display” menu, and then select the “Make this my main display” option and click “Apply”. This enables the monitor to display images properly.
5. Confirm that the recommended resolution for the monitor is set in the “Resolution” menu. (“(recommended)” is displayed after the resolution.)
6. To change the size of text and icons, click “Make text and other items larger or smaller”, select a size according to personal preference on the settings screen, and then click “Apply”.
7. If a message prompting you to sign out/log off is displayed after changing the settings, sign out/log off and then sign in/log in again.

● mac OS

1. Select “System Preferences” from the Apple menu.
2. When the “System Preferences” panel is displayed, click “Displays”.
3. If multiple monitors, including notebook PC screens, are connected to the computer, make sure that “Mirror Displays” is not selected on the “Arrangement” tab. If it is selected, remove the check mark.
4. Select the “Display” tab, and make sure that “Default for display” is selected for “Resolution”. If it is not selected, add a check mark. The correct resolution has now been set for your display. Close the “System Preferences” panel. If multiple monitors, including notebook PC screens, are connected to the computer, configure these settings in “Display” on each monitor.
5. To select a resolution according to personal preference, select “Scaled” and then select a resolution (either from a list or icons), and then close the panel.

Chapter 2 Basic Adjustments/Settings

This chapter describes the basic functions that can be set by touching the switches on the front of the monitor.

For advanced adjustment and setting procedures using the Setting menu, see “Chapter 5 Advanced Adjustments/Settings” (page 22).

2-1. Switch Operation Method

1. Displaying the operation guide

1. Touch any switch (except ).
The operation guide appears on the screen.

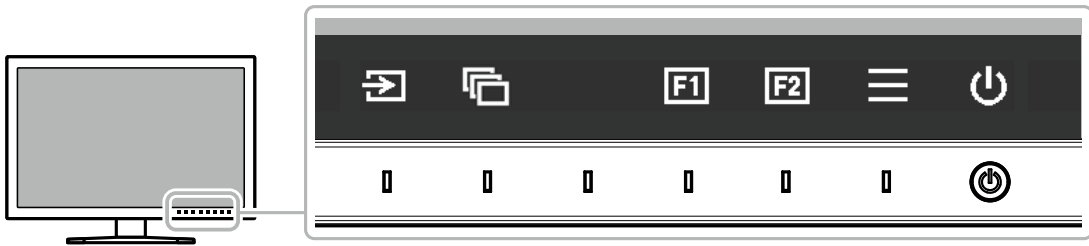

2. Setting

1. Touch a switch for setting.
The Setting menu appears.
2. Use the switches to adjust/set the selected item, and then select  to confirm.













3. Exiting

1. Select  to exit the menu.
2. When no menu is displayed, the operation guide will automatically disappear after a few seconds if no switches are operated.

Note

- The contents of the guide will differ depending on the selected menu or status.

● Operation Guide Icons

Icon	Description
	Switches the input signal.
	Switches the color mode.
	Executes the function assigned to Custom Key 1.
	Executes the function assigned to Custom Key 2.
	Displays the Setting menu.
	Returns to the previous screen.
   	Moves the cursor.
	Executes the selected operation.
	Turns the monitor's power on or off.

2-2. Switching Input Signals

When a monitor has multiple signal inputs, the signal to display on-screen can be changed.

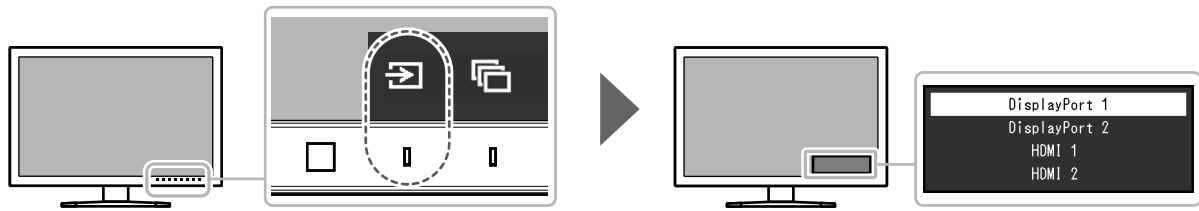

2-3. Switching the Display Mode (color mode)

This function allows easy selection of a display mode according to monitor application.

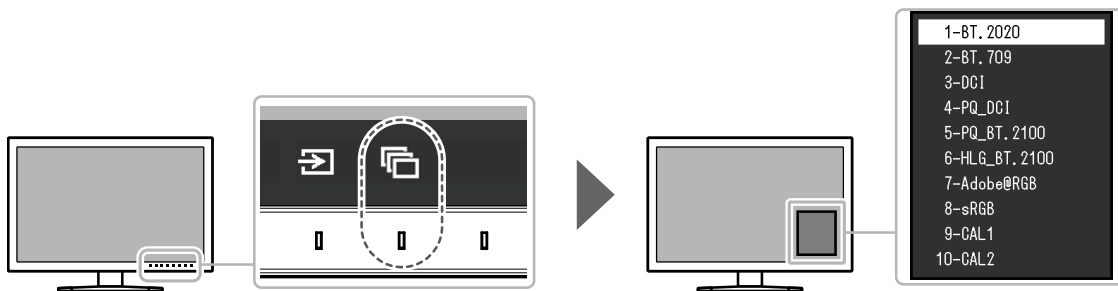

● Display Modes

Color Mode	Purpose
Standard Mode	Adjust color using the monitor's Setting menu.
BT.2020	See "Color Mode Setting Values" (page 13) for detailed setting values for each color mode.
BT.709	
DCI	
PQ_DCI	
PQ_BT.2100	
HLG_BT.2100	
Adobe®RGB	
sRGB	
Calibration Mode (CAL mode)	Adjusts the monitor's color using the monitor's SelfCalibration function or color management software "ColorNavigator 6" or "ColorNavigator NX".
CAL1	Displays the screen adjusted by SelfCalibration, ColorNavigator 6, or ColorNavigator NX.
CAL2	

● Color Mode Setting Values

-: Cannot be changed

Item		Color Mode										
		BT.2020	BT.709	DCI	PQ_DCI	PQ_BT.2100	HLG_BT.2100	Adobe® RGB	sRGB	CAL1 / CAL2		
Brightness (cd/m ²)		100	100	48	300	300	300	120	120	-		
Temperature		D65	D65	D65	D65	D65	D65	D65	D65	-		
Gamma (EOTF)		2.4	2.4	2.6	PQ	PQ	HLG	2.2	sRGB	-		
PQ / HLG Clipping (cd/m ²)		-	-	-	1000	1000	Off	-	-	-		
HLG System Gamma		-	-	-	-	-	1.2	-	-	-		
Color Gamut		BT.2020	BT.709	DCI	DCI	BT.2020	BT.2020	Adobe® RGB	sRGB	-		
Advanced Settings	Hue	0	0	0	0	0	0	0	0	-		
	Saturation	0	0	0	0	0	0	0	0	-		
	Gamut Clipping	On	Off	Off	Off	On	On	Off	Off	-		
	XYZ Format	-	-	Off	Off	-	-	-	-	-		
	Gain	Red	Calculated from color temperature								-	
		Green	Calculated from color temperature								-	
		Blue	Calculated from color temperature								-	
	Black Level	Red	0	0	0	0	0	0	0	0	-	
		Green	0	0	0	0	0	0	0	0	-	
		Blue	0	0	0	0	0	0	0	0	-	
	6 Colors	Magenta	Hue	0	0	0	0	0	0	0	0	-
			Saturation	0	0	0	0	0	0	0	0	-
			Lightness	0	0	0	0	0	0	0	0	-
		Red	Hue	0	0	0	0	0	0	0	0	-
			Saturation	0	0	0	0	0	0	0	0	-
			Lightness	0	0	0	0	0	0	0	0	-
		Yellow	Hue	0	0	0	0	0	0	0	0	-
			Saturation	0	0	0	0	0	0	0	0	-
			Lightness	0	0	0	0	0	0	0	0	-
		Green	Hue	0	0	0	0	0	0	0	0	-
			Saturation	0	0	0	0	0	0	0	0	-
Lightness			0	0	0	0	0	0	0	0	-	
Cyan	Hue	0	0	0	0	0	0	0	0	-		
	Saturation	0	0	0	0	0	0	0	0	-		
	Lightness	0	0	0	0	0	0	0	0	-		
Blue	Hue	0	0	0	0	0	0	0	0	-		
	Saturation	0	0	0	0	0	0	0	0	-		
	Lightness	0	0	0	0	0	0	0	0	-		

Note

- Use ColorNavigator 6 or ColorNavigator NX to set CAL1 / CAL2. These settings cannot be changed in the Setting menu on the monitor.
- A color mode can be set for each input signal.
- See “Color” (page 25) for details about each item.
- You can disable specific color mode selections. For more information, see “Mode Skip” (page 37).

Chapter 3 SelfCalibration

This product is equipped with a built-in calibration sensor. By setting the calibration targets and execution schedule in advance, the calibration sensor automatically operates and regularly calibrates the monitor. This automatic calibration function is called "SelfCalibration".

The adjustment content of SelfCalibration differs depending on the color mode that is executed.

- Calibration Mode (CAL mode: CAL1 / CAL2):
 - When performing SelfCalibration on the monitor itself, calibrate the monitor to match the set targets.
 - When using ColorNavigator 6 or ColorNavigator NX, use a measurement device with the software to maintain the calibrated state of the monitor.
- Standard Mode (color mode excluding CAL1 / CAL2): the monitor's color reproduction gamut is updated and each display mode in Standard Mode is adjusted as follows:
 - The temperature is adjusted so that it is as close as possible to the specified value.
 - The gamut values are adjusted so that they are close to each specified value.
 - Information on brightness is updated.

Note

- SelfCalibration can be executed 30 minutes after turning on the monitor.
 - SelfCalibration can also be executed when there are no external device signals being input.
 - To preserve adjustments that you set by using ColorNavigator 6 or ColorNavigator NX, it is recommended to execute SelfCalibration.
 - Because brightness and chromaticity will change as you use the monitor, it is recommended to calibrate the monitor periodically.
 - The measurement results from the built-in calibration sensor can be correlated with the measurement results from the external measurement device that you want to use as a reference. For details, refer to the User's Manual of ColorNavigator 6 or ColorNavigator NX.
-

You can set the calibration targets and execution schedule by using ColorNavigator 6 or ColorNavigator NX or the monitor's Setting menu.

You can download the ColorNavigator 6 or ColorNavigator NX software and User's Manual from our web site:

www.eizoglobal.com

Note

- When using the software, you will need to connect a PC to the monitor with the supplied USB cable.
 - For details on the USB cable connection, see "[Connection Procedure](#)" (page 51).
 - While using the software, do not operate the power switch or operation switches on the front side of the monitor.
-

● SelfCalibration functions

Set the details for "SelfCalibration".

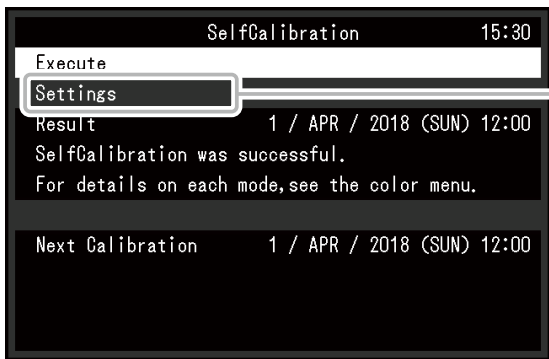

Function		Adjustable Range		Description	
Execute		-		SelfCalibration can be executed manually regardless of the schedule. Note <ul style="list-style-type: none"> After selecting "Execute", warming up (after the power to the monitor is switched on, leaving the monitor on for a certain period of time until the display becomes stable) may be executed before the built-in calibration sensor comes out. 	
Settings	Mode Settings	Standard Mode		On Off	Switch between enabling/disabling SelfCalibration in Standard Mode.
		Calibration Mode	CAL1 CAL2	On Off	Switch between enabling/disabling SelfCalibration in each color mode.
	Schedule	Start time	Power Save Immediately Application Off	Select the timing to execute SelfCalibration upon reaching the time set in the schedule. <ul style="list-style-type: none"> "Power Save" To be executed under any of the following conditions. <ul style="list-style-type: none"> When the monitor is in "Power Save" mode or power is off at the set time. The monitor shifts to the power saving mode or the power is turned off when the set time in the schedule is exceeded. "Immediately" SelfCalibration is executed immediately at the set time. "Application" Execute SelfCalibration according to the timing set using ColorNavigator Network. For details on ColorNavigator Network, refer to our web site (www.eizoglobal.com). "Off" SelfCalibration is not executed. 	
	Frequency	Daily Weekly Monthly Quarterly Biannually Annually Usage Time	Select the SelfCalibration execution cycle.		

Function		Adjustable Range	Description
Settings	Schedule	Timing	<p>Jan/Apr/Jul/Oct Feb/May/Aug/Nov Mar/Jun/Sep/Dec Jan/Jul Feb/Aug Mar/Sep Apr/Oct May/Nov Jun/Dec Jan to Dec Every 50 hours to Every 500 hours</p> <p>When the execution cycle is "Quarterly", "Biannually", "Annually", or "Usage Time", select the timing for executing SelfCalibration.</p> <p>The setting range differs depending on the execution cycle setting.</p> <ul style="list-style-type: none"> "Quarterly": Jan/Apr/Jul/Oct, Feb/May/Aug/Nov, Mar/Jun/Sep/Dec "Biannually": Jan/Jul, Feb/Aug, Mar/Sep, Apr/Oct, May/Nov, Jun/Dec "Annually": Jan to Dec "Usage Time": Every 50 hours to Every 500 hours
		Week	<p>1st week to 5th week</p> <p>When the execution cycle is "Monthly", "Quarterly", "Biannually", or "Annually", select the week for executing SelfCalibration.</p> <p>Note</p> <ul style="list-style-type: none"> When no day has been selected for "Day" in the selected week, the week of execution will be as follows: <ul style="list-style-type: none"> - When the selected week is "1st week": 2nd week - When the selected week is "5th week": 4th week
		Day	<p>Sunday to Saturday</p> <p>When the execution cycle is "Weekly", "Monthly", "Quarterly", "Biannually", or "Annually", select the day for executing SelfCalibration.</p>
		Time	<p>0:00 to 11:55 PM</p> <p>When the execution cycle is "Daily", "Weekly", "Monthly", "Quarterly", "Biannually", or "Annually", select the time for executing SelfCalibration.</p>
	Clock Adjustment	-	<p>Set the monitor date and time.</p> <p>Note</p> <ul style="list-style-type: none"> When the clock has not been set, the schedule will not be applied. If the main power supply is disconnected for an extended period of time, the clock may need resetting. When ColorNavigator 6 or ColorNavigator NX is started, the date and time are automatically set.
Result		-	The SelfCalibration execution result is displayed.
Next Calibration		-	The next SelfCalibration scheduled execution date is displayed.

3-1. Setting targets

Set calibration targets for Calibration Mode. You can set targets by using ColorNavigator 6 or ColorNavigator NX, or on the monitor itself.

When using the monitor itself, set the following functions in the "Color" menu.

- "Color Mode"
Select the color mode (CAL mode: CAL1 / CAL2) you want to set a target for.
- "Target Settings"
Set a calibration target for SelfCalibration.

3-2. Executing

SelfCalibration can be executed by setting a schedule or it can be executed regardless of a schedule. You can set a schedule by using ColorNavigator 6 or ColorNavigator NX, or on the monitor itself. When executing SelfCalibration by setting a schedule on the monitor itself, the method to set the schedule differs depending on the type of color mode (Standard Mode or Calibration Mode).

Attention

- If there is a change in the video signal from the external device during SelfCalibration (the signal disappears, a signal is input during a no-signal state, or other), SelfCalibration is automatically canceled.
-

● Executing regardless of a schedule

Manually execute SelfCalibration.

There are two methods for executing SelfCalibration, as follows.

- Execute from the "SelfCalibration" menu
In the "SelfCalibration" menu, select "Execute".
SelfCalibration is executed for all the color modes selected as "On" in "Settings" - "Mode Settings" of the "SelfCalibration" menu.
- Executing from the "Color" menu
In "Color Mode" in the "Color" menu, select the color mode (CAL mode: CAL1 / CAL2) you want to execute, and then select "Execute Calibration".
Execute SelfCalibration for the displayed color mode.

● Executing by setting a schedule

Set the calibration schedule for SelfCalibration.

In "Settings" in the "SelfCalibration" menu, set the calibration schedule and monitor date and time for SelfCalibration.

Attention

- If a scheduled SelfCalibration is automatically canceled, it is executed again when the monitor transitions to the power saving mode an hour or more after cancellation or when the monitor is turned off using .
SelfCalibration can also be executed regardless of the schedule.
-

● Activating SelfCalibration in Standard Mode

Execute SelfCalibration in Standard Mode.

In "Settings" in the "SelfCalibration" menu, set the following functions:

- "Mode Settings"
Set "Standard Mode" to "On".

● **Activating SelfCalibration in Calibration Mode (CAL mode)**

Execute SelfCalibration in Calibration Mode (CAL mode).

In "Settings" in the "SelfCalibration" menu, set the following functions:

- "Mode Settings"
Select "Calibration Mode".
- "Calibration Mode"
Select the color mode (CAL mode: CAL1 / CAL2) you want to execute, and set "On".

3-3. Checking results

Check the SelfCalibration calibration results by using the monitor.

In the "Color" menu, set the following functions:

- "Color Mode"
Select the color mode (CAL mode: CAL1 / CAL2) for which you want to check the result.
- "Result"
Check the calibration result of SelfCalibration.

Chapter 4 Custom Key Settings

You can assign functions to the custom keys to easily start specified functions.
This chapter describes how to operate the custom keys and how to assign functions to the custom keys.



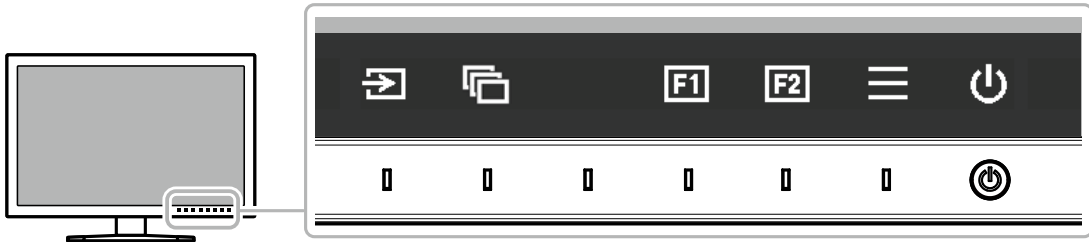

4-1. Basic Operation of the Custom Keys

1. Displaying the operation guide

1. Touch any switch (except ).
The operation guide appears.



2. Execute

1. Select  or .
The function assigned to  or  is executed.

Note

- If you touch a custom key to which no function has been assigned, the menu for assigning a function to that custom key appears.

4-2. Assigning a Function to a Custom Key

1. Displaying the operation guide

1. Touch any switch (except ).
The operation guide appears.

2. Setting

1. Select .
The Setting menu appears.



- Use **^** **v** to select "Preferences", and then select **✓**.

The Preferences menu appears.

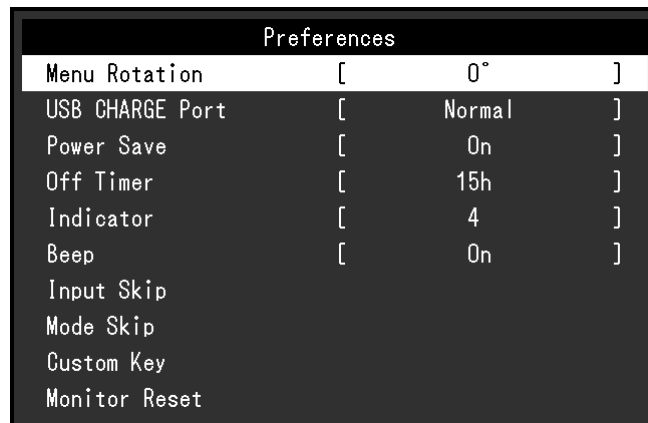

- Use **^** **v** to select "Custom Key", and then select **✓**.

The Custom Key menu appears.

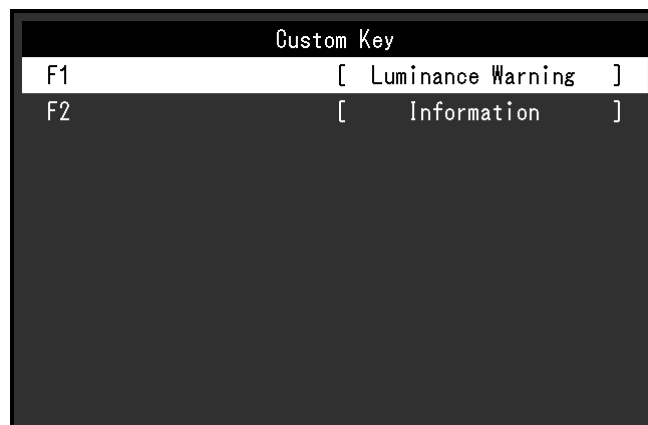

- Use **^** **v** to select the custom key to which you want to assign a function, and then select **✓**.

The menu for assigning a function appears.

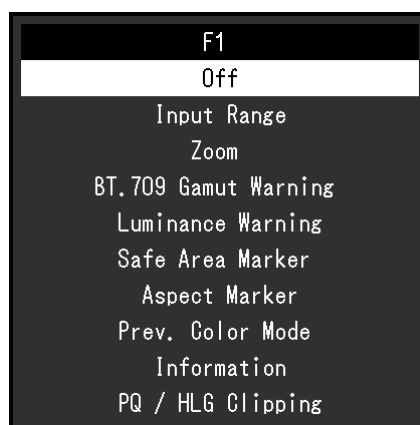

- Use **^** **v** to select the function that you want to assign, and then select **✓**.

That function is assigned to the custom key.

3. Exiting

1. Press **×** several times.
The Setting menu exits.

● Functions that can be Assigned to Custom Keys

Function	Description
Off	Disables the custom key even when it is touched.
Input Range	Sets the Input Range function. For more information, see page 24 .
Zoom	Sets the Zoom function. For more information, see page 32 .
BT.709 Gamut Warning	Sets the BT.709 Gamut Warning function. For more information, see page 33 .
Luminance Warning	Sets the Luminance Warning function. For more information, see page 34 .
Safe Area Marker	Sets the Safe Area Marker function. For more information, see page 34 .
Aspect Marker	Sets the Aspect Marker function. For more information, see page 35 .
Prev. Color Mode	You can return to the previous color mode. This is convenient for checking the differences between two color modes.
Information	<p>You can view the input signal information and color information.</p> <p>Example:</p> <div style="display: flex; justify-content: space-around;"> <div style="border: 1px solid black; padding: 5px; background-color: #333; color: #eee; width: 45%;"> <p style="text-align: center; margin: 0;">Information</p> <p>Signal</p> <p>Input Color Format Auto (YUV 4:2:2)</p> <p>Input Range Auto (Limited)</p> <p>Signal Information</p> <p>HDMI 1</p> <p>4096 X 2160 60.00 Hz</p> <p>Limited Range</p> <p>YCbCr4:2:2</p> <p>BT.709</p> <p>Hybrid Log Gamma</p> </div> <div style="border: 1px solid black; padding: 5px; background-color: #333; color: #eee; width: 45%;"> <p style="text-align: center; margin: 0;">Information (2/2)</p> <p>Color</p> <p>Color Mode BT.2020</p> <p>Brightness 100cd/m2</p> <p>Temperature 6500K</p> <p>Gamma (EOTF) 2.2</p> <p>PQ / HLG Clipping -</p> <p>HLG System Gamma -</p> <p>Color Gamut BT.2020</p> </div> </div> <p>Note</p> <ul style="list-style-type: none"> • You can check the monitor information under “Information” (page 38) on the Setting menu.
PQ / HLG Clipping	Set the PQ / HLG clipping function. For more information, see page 26 .

Chapter 5 Advanced Adjustments/Settings

This chapter describes the advanced monitor adjustment and setting procedures using the Setting menu. For the basic setting functions using the switches on the front of the monitor, see "[Chapter 2 Basic Adjustments/Settings](#)" (page 11).

5-1. Basic Operation of the Setting Menu

1. Menu display

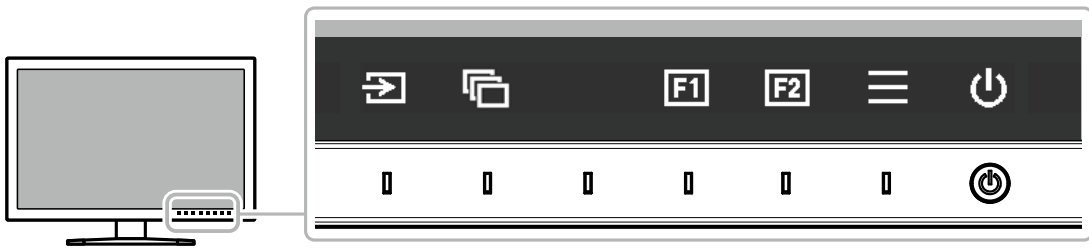

1. Touch any switch (except ).
The operation guide appears.



2. Select  .
The Setting menu appears.



2. Adjusting/setting

1. Choose a menu to adjust/set with   , and then select  .
The Sub menu appears.

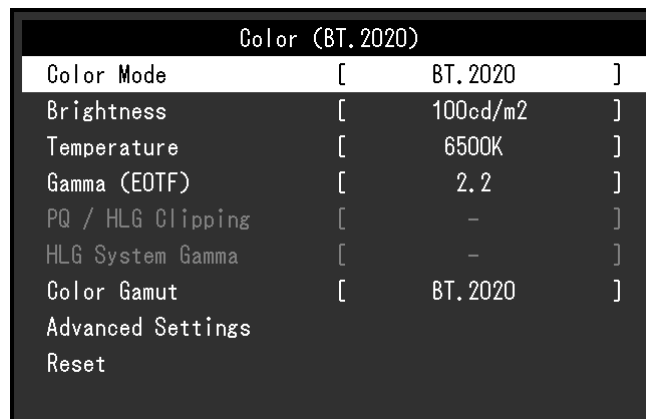

- Choose an item to adjust/set with **▲ ▼**, and then press **✓**.
The Adjustment/Setting menu appears.



- Adjust/set the selected item with **< >**, and then select **✓**.
The Sub menu appears.
Selecting **✕** during adjustment/setting will cancel the adjustment/setting and restore the state prior to making changes.

3. Exiting

- Select **✕**.
The Setting menu appears.
- Select **✕**.
The Setting menu exits.

Note

- The contents of the guide will differ depending on the selected menu or status.

5-2. Setting Menu Functions

● Signal

The signal settings are used to configure advanced settings for input signals, such as the screen display size and color format.

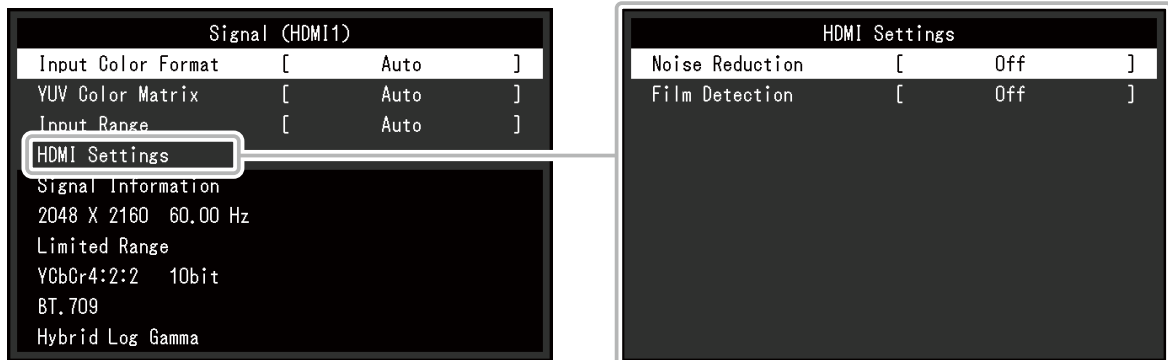

Function	Adjustable Range	Description
Input Color Format	Auto YUV*1 YUV 4:2:2*2 YUV 4:4:4*2 RGB	The color space of the input signal can be specified. Try changing this setting if colors are not displayed correctly. When inputting YUV 4:2:0, select "Auto".

*1 Only enabled during DisplayPort input

*2 Only enabled during HDMI input

Function		Adjustable Range	Description
YUV Color Matrix		Auto BT.601 BT.709 BT.2020	Select the YUV format of the input signal. Use this setting for gradation collapse or other occurrences where the screen is displayed incorrectly because of a problem with the input signal.
Input Range		Auto Full Limited (109 % white) Limited	<p>Depending on the external device, the black and white levels in the video signal output to the monitor may be restricted. If the signal is displayed on the monitor in its restricted form, the blacks will be faint, the whites dull, and contrast will be reduced. The brightness range of such signals can be extended to match the actual contrast ratio of the monitor.</p> <ul style="list-style-type: none"> • "Auto" The monitor automatically recognizes the brightness range of input signals and displays images appropriately. • "Full" The input signal brightness range is not extended. • "Limited (109 % white)" The brightness range of the input signal is extended from 16 - 254 (10 bits: 64 - 1019) to 0 - 255 (10 bits: 0 - 1023) for display. • "Limited" The brightness range of the input signal is extended from 16 - 235 (10 bits: 64 - 940) to 0 - 255 (10 bits: 0 - 1023) for display.
HDMI Settings	Noise Reduction	On Off	<p>The small noises that occur in dark areas of an image are reduced. Use this function to reduce noise and roughness in images.</p> <p>Note</p> <ul style="list-style-type: none"> • This can only be set when there is HDMI input. • Using the Noise Reduction function may lead to deterioration of fine images.
	Film Detection	On Off	<p>When displaying an interlaced signal, a display method can be selected. For video, CG, animation, etc., the 24 fps or 30 fps signal is automatically detected, and the optimal image is displayed.</p> <p>Note</p> <ul style="list-style-type: none"> • This can only be set when there is HDMI input. • "Film Detection" is enabled only when a 1080i signal is input. • If the video does not display normally when "Film Detection" is set to "On", change the setting to "Off".
Signal Information		-	<p>You can check the information for the input signal. The following information is displayed:</p> <ul style="list-style-type: none"> • Resolution • Vertical scan frequency • Input range • Color format • Color depth • Colorimetry • EOTF <p>Attention</p> <ul style="list-style-type: none"> • When "SMPTE170M/BT.709" is displayed in "Signal Information" during HDMI input, signals from the outputting device may not be displayed properly. In such a case, try changing the settings for the outputting device or reconnecting the device using DisplayPort input.

● Color

The setting details differ depending on the color mode selected.

When the color mode is Standard Mode (BT.2020 / BT.709 / DCI / PQ DCI / PQ_ BT.2100 / HLG_ BT.2100 / Adobe® RGB / sRGB)

Each color mode setting status can be adjusted according to personal preference.

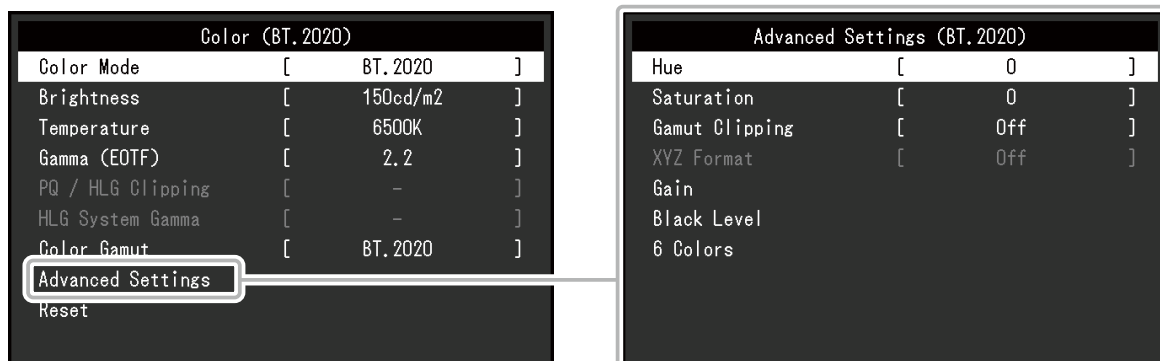

Attention

- The same image may be seen in different colors on multiple monitors due to differences between individual monitors. Make fine color adjustment visually when matching colors on multiple monitors.

Note

- Use the values shown in "cd/m²", "K", and "%" as a guide only.

Function	Adjustable Range	Description
Color Mode	BT.2020 BT.709 DCI PQ_DCI PQ_BT.2100 HLG_BT.2100 Adobe® RGB sRGB CAL1 CAL2	Switch to the desired mode according to the monitor application. Note • For more information on how to switch modes, see "2-3. Switching the Display Mode (color mode)" (page 12) . • Regarding "CAL1 / CAL2" see page 28 .
Brightness	40 cd/m ² to 350 cd/m ²	The screen brightness is adjusted by changing the brightness of the backlight (light source from the LCD back panel). Note • If a value that cannot be set is selected, the value will appear in magenta. In such a case, change the value.

Function	Adjustable Range	Description
Temperature	Native 4000 K to 10000 K D50 D65 DCI User	<p>The color temperature can be adjusted.</p> <p>The color temperature is used to express the chromaticity of "White". The value is expressed in degrees "K" (Kelvin). The screen becomes reddish at a low color temperature, and bluish at a high color temperature, like the temperature of a flame.</p> <p>Specify a color temperature in units of 100 K, or select a standard name.</p> <p>Note</p> <ul style="list-style-type: none"> • When you select "Native", the original color of the LCD panel (Gain: 100 % for each RGB) is displayed. • "Gain" allows you to perform more advanced adjustment. When gain is changed, the color temperature is changed to "User". • The gain preset values are set for each color temperature setting value.
Gamma (EOTF)	1.6 to 2.7 sRGB EBU(2.35) PQ HLG	<p>Adjust the gamma.</p> <p>The brightness of the monitor varies depending on the input signal, however, the variation rate is not simply proportional to the input signal. The control performed to keep the balance between the input signal and the brightness of the monitor is called "Gamma correction".</p> <p>Set the gamma, or select a standard name.</p> <p>Note</p> <ul style="list-style-type: none"> • If you select "HLG", you must set "HLG System Gamma".
PQ / HLG Clipping	(Gamma (EOTF): PQ) 300 cd/m ² 500 cd/m ² 1000 cd/m ² 4000 cd/m ² Off (Gamma (EOTF): HLG) On Off	<ul style="list-style-type: none"> • If "PQ" is selected for "Gamma (EOTF)", areas with brightness equal to or greater than the value set here are displayed as clipping at this setting value for the signal that is input to the monitor. • If "HLG" is selected for "Gamma (EOTF)", set On / Off for clipping. If you select "On" when the brightness is set to 300 cd/m², any area that exceeds 300 cd/m² is clipped. <p>Note</p> <ul style="list-style-type: none"> • This can be set when "PQ" or "HLG" is specified for "Gamma (EOTF)". • You can check the areas where clipping occurs. For more information, see "Luminance Warning" (page 34).
HLG System Gamma	1.0 to 1.5	<p>Adjust the system gamma value for the HLG signal that is input to the monitor.</p> <p>Note</p> <ul style="list-style-type: none"> • This can be set when "HLG" is specified for "Gamma (EOTF)".
Color Gamut	Native Adobe®RGB sRGB EBU BT.709 BT.2020 SMPTE-C DCI	<p>Set the color reproduction area (color gamut). "Color Gamut" is the range of colors that can be represented. Multiple standards are defined.</p> <p>Note</p> <ul style="list-style-type: none"> • Select "Native", to display the original color gamut of the monitor. • The method of displaying colors outside the monitor's displayable range within the defined color gamut can be set. For more information, see "Gamut Clipping" (page 27).

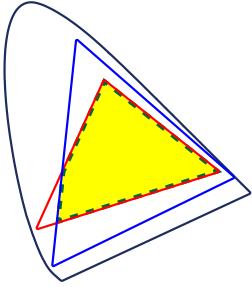
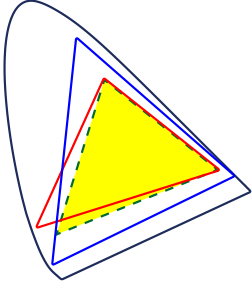
	Function	Adjustable Range	Description
Advanced Settings	Hue	-100 to 100	<p>The hue can be adjusted.</p> <p>Note</p> <ul style="list-style-type: none"> Using this function may make some color gradations unavailable for display.
	Saturation	-100 to 100	<p>The saturation can be adjusted.</p> <p>Note</p> <ul style="list-style-type: none"> Using this function may make some color gradations unavailable for display. The minimum value (-100) changes the screen to monochrome.
	Gamut Clipping	On Off	<p>The method of displaying colors outside the monitor's displayable range within the color gamut specified in accordance with "Color Gamut" (page 26) can be set.</p> <ul style="list-style-type: none"> "On" <p>The range of colors that are displayable on the monitor will be accurately displayed in accordance with the standard. Colors outside the displayable range will be saturated.</p>  "Off" <p>Displays colors with priority on the color gradation rather than the color accuracy. The vertices of the color gamut defined in the standard move to a range that can be displayed by the monitor. This allows the closest colors displayable by the monitor to be displayed.</p>  <p> — Color gamut displayable by the monitor — Color gamut defined by standard - - - Color gamut displayed on screen </p> <p>Note</p> <ul style="list-style-type: none"> The diagrams shown above are conceptual diagrams, and they do not display the actual color gamut of the monitor. This setting will be disabled if "Native" is selected at "Color Gamut" (page 26).
	XYZ Format	On Off	<p>If this function is set to "On", the XYZ signal for digital cinema can be displayed on the monitor.</p> <p>Note</p> <ul style="list-style-type: none"> This can be set only when "Color Gamut" (page 26) is set to "DCI". If you select "On", you cannot set "Color Gamut".
Gain	0 % to 100 %	<p>The brightness of each color component red, green, and blue is called Gain. The chromaticity of "white" can be changed by adjusting the gain.</p> <p>Note</p> <ul style="list-style-type: none"> Using this function may make some color gradations unavailable for display. The gain value changes according to the color temperature. When gain is changed, the color temperature is changed to "User". 	

Function		Adjustable Range	Description
Advanced Settings	Black Level	0 to 1500	You can adjust the brightness and chromaticity of black by adjusting the black level for red, green, and blue. Display the black test pattern or the background and adjust the black level.
	6 Colors	-100 to 100	The hue, saturation and lightness (brightness) can each be adjusted for the colors Magenta, Red, Yellow, Green, Cyan, and Blue.
Reset		-	Resets any color adjustment values for the currently selected color mode back to the default settings.

When the color mode is Calibration Mode (CAL mode: CAL1 / CAL2)

You can switch color mode, set targets for SelfCalibration, and execute calibration.

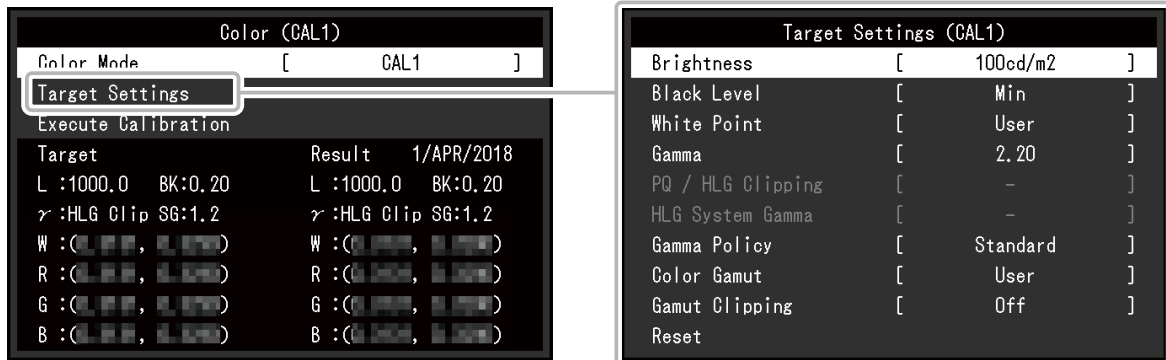

Function	Adjustable Range	Description
Color Mode	BT.2020 BT.709 DCI PQ_DCI PQ_BT.2100 HLG_BT.2100 Adobe® RGB sRGB CAL1 CAL2	Switch to the desired mode according to the monitor application. Note <ul style="list-style-type: none"> For more information on how to switch modes, see "2-3. Switching the Display Mode (color mode)" (page 12). Regarding "BT.2020 / BT.709 / DCI / PQ_DCI / PQ_BT.2100 / HLG_BT.2100 / Adobe® RGB / sRGB", see page 25.

Function		Adjustable Range	Description	
Target Settings	Brightness	Min 40 cd/m ² to 350 cd/m ² Max	Set the brightness that will be used as a calibration target for SelfCalibration.	
	Black Level	Min 0.2 to 3.5	Set the black level that will be used as a calibration target for SelfCalibration.	
	White Point	Temperature	4000 K to 10000 K User D50 D65 DCI	Set the White Point that will be used as a calibration target for SelfCalibration. Set the White Point using the color coordinates (White(x) / White(y)) or color temperature. When specifying color coordinates, set the values for "White(x)" and "White(y)", respectively. When specifying the color temperature, set the color temperature in units of 100 K or select a color temperature according to each standard.
		White(x) / White(y)	0.2400 to 0.4500	Note • When color coordinates are specified, the color temperature is changed to "User".
	Gamma (EOTF)	1.00 to 2.70 sRGB EBU(2.35) L* PQ HLG Fixed	Set the gamma that will be used as a calibration target for SelfCalibration. Set the gamma, or select the gamma curve defined by each standard. Note • The "Gamma (EOTF)" becomes "Fixed" when adjusting with ColorNavigator 6 or ColorNavigator NX.	
	PQ / HLG Clipping	(Gamma (EOTF): PQ) 300 cd/m ² 500 cd/m ² 1000 cd/m ² 4000 cd/m ² Off (Gamma (EOTF): HLG) On Off	Set the PQ / HLG clipping that will be used as a calibration target for SelfCalibration. Note • This can be set when "PQ" or "HLG" is specified for "Gamma (EOTF)".	
	HLG System Gamma	1.0 to 1.5	Set the HLG system gamma that will be used as a calibration target for SelfCalibration. Note • This can be set when "HLG" is specified for "Gamma (EOTF)".	

	Function	Adjustable Range	Description	
Target Settings	Gamma Policy	Standard Gray Balance Fixed Gamma	<p>Select the gamma adjustment method for SelfCalibration.</p> <ul style="list-style-type: none"> "Standard" Adjust the gray balance while retaining the contrast. "Gray Balance" Adjust the monitor so that the chromaticity of the middle tone area equals the white point. "Fixed Gamma" Select to use specific gamma settings. <p>Attention</p> <ul style="list-style-type: none"> If "HLG" is specified for "Gamma (EOTF)", "Fixed Gamma" is selected and this setting cannot be changed. With "Gray Balance", all points of the grayscale are adjusted toward the target white point. Select this to prioritize whiteness when correcting the middle tone area. However, the following restrictions apply when "Gray Balance" is selected: <ul style="list-style-type: none"> The contrast may decrease. The color gamut may be narrower than when adjusting with "Fixed Gamma". 	
	Color Gamut	Native Adobe®RGB sRGB EBU BT.709 BT.2020 SMPTE-C DCI User	<p>Set the color gamut that will be used as a calibration target for SelfCalibration.</p> <p>In "Color Gamut", the color gamut defined by each standard can be selected.</p> <p>To set a color gamut other than those specified by each standard, specify the color coordinates of each RGB color, and the display method ("Gamut Clipping") of colors outside the color gamut of the monitor.</p> <p>Note</p> <ul style="list-style-type: none"> When you select "Native" in "Color Gamut", the preset color gamut of the monitor is displayed. When color coordinates are specified in the color gamut settings, the color gamut is changed to "User". 	
		Red(x) / Red(y) / Green(x) / Green(y) / Blue(x) / Blue(y)	0.0000 to 1.0000	
		Gamut Clipping	On Off	
	Reset	-	Resets any calibration targets and calibration result for the currently selected color mode back to the default settings.	



● SelfCalibration

Refer to ["SelfCalibration functions"](#) (page 15).

● Screen

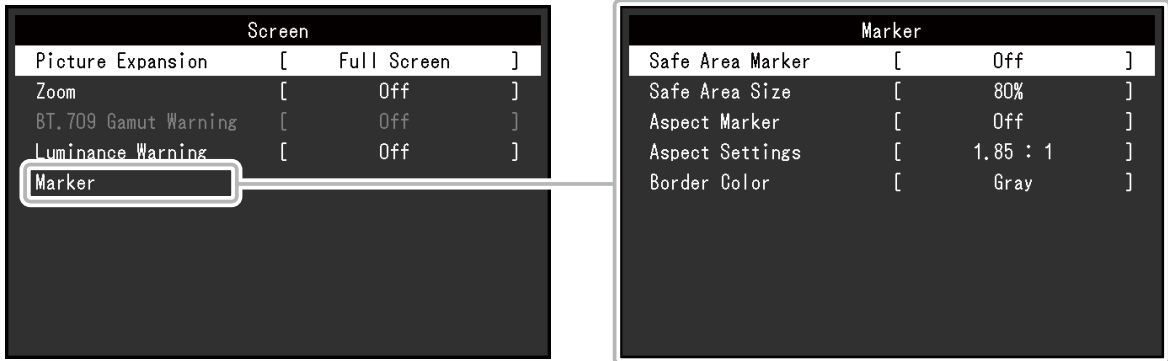
The signal settings are used to configure advanced settings for input signals, such as the screen display size and color format.

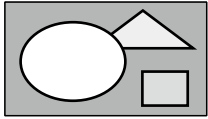
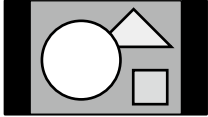

Function	Adjustable Range	Description
Picture Expansion	Auto Full Screen Aspect Ratio Dot by Dot	<p>The screen size of the monitor display can be changed.</p> <ul style="list-style-type: none"> "Auto" The monitor automatically changes the screen size according to the resolution information and aspect ratio information from the input signal (only for HDMI input). "Full Screen" Displays an image in full screen. Images are distorted in some cases because the magnification ratio is not necessarily fixed vertically and horizontally. "Aspect Ratio" Displays an image in full screen. However, since aspect ratios are maintained, part of an image may not be visible in horizontal or vertical direction. "Dot by Dot" Displays the image at the set resolution or at the size specified by the input signal. <p>Note</p> <ul style="list-style-type: none"> Example settings <ul style="list-style-type: none"> - Full Screen  - Aspect Ratio  - Dot by Dot (Input Signal) 

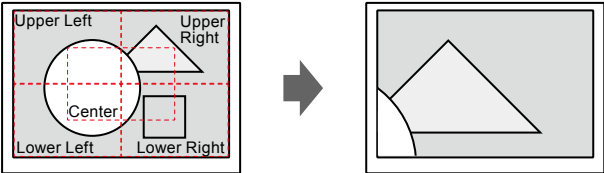
Function	Adjustable Range	Description
Zoom	Off Center Lower Left Upper Left Upper Right Lower Right	<p data-bbox="756 232 1434 353">When a 4K signal (a signal with a resolution of 4096 × 2160 or 3840 × 2160) is displayed on the monitor, the specified area can be doubled in size. This is convenient for checking details in an image.</p> <div data-bbox="788 405 1394 577">  <p>The diagram illustrates the zoom function. On the left, a square frame is divided into four quadrants by a horizontal and a vertical dashed red line. The quadrants are labeled: 'Upper Left' (top-left), 'Upper Right' (top-right), 'Lower Left' (bottom-left), and 'Lower Right' (bottom-right). A circle is drawn in the 'Center' area, and a square is drawn in the 'Lower Right' area. A grey arrow points to the right, where a larger square frame shows the 'Upper Right' quadrant of the original image enlarged to fill most of the frame. This is labeled 'Example: Enlarging "Upper Right"'. The enlarged image shows a close-up of a triangle and a curved line.</p> </div> <p data-bbox="767 618 820 640">Note</p> <ul data-bbox="767 651 1386 741" style="list-style-type: none"> • You cannot use this function if "Picture Setup" (page 41) in the "Administrator Settings" menu is set to "Dual". • You cannot use this function with a 4K HDMI signal.

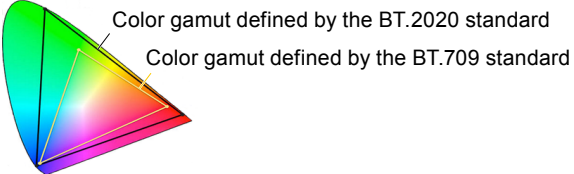
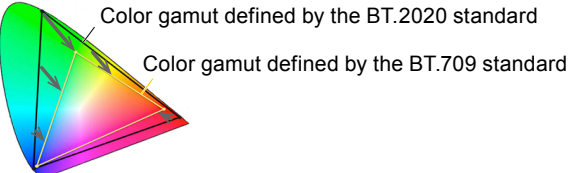
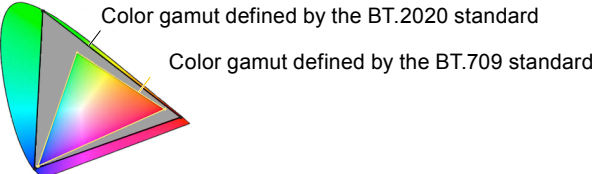
Function	Adjustable Range	Description
BT.709 Gamut Warning	Off Clip On	<p>If "Color Gamut" is set to "BT.2020" and a signal is input that complies with the ITU-R BT.2020 standard, you can set the display method for colors that exceed the color gamut for the BT.709 standard.</p> <ul style="list-style-type: none"> • "Off" Images are displayed according to the color gamut for BT.2020. (The actual color gamut that is displayed on the monitor will depend on the setting for "Gamut Clipping" (page 27).)  <ul style="list-style-type: none"> • "Clip" Colors that are outside of the color gamut for BT.709 are expressed within the color gamut for BT.709 (clipping occurs).  <ul style="list-style-type: none"> • "On" Colors that are outside of the color gamut for BT.709 are displayed in gray.  <p>Note</p> <ul style="list-style-type: none"> • This function can be set only when "Color Gamut" (page 26) is set to "BT.2020". • If this function is set to "On" or "Clip", the "Luminance Warning" function is automatically set to "Off".





Function		Adjustable Range	Description
Luminance Warning		Off On (Yellow) On (Magenta)	<p>You can check areas with a brightness that is higher than the brightness that is set for the PQ / HLG Clipping function for the input signal (areas where clipping occurs).</p> <p style="text-align: right;">Example: Setting On (Magenta)</p>  <p>Note</p> <ul style="list-style-type: none"> • If this function is set to "On", the "BT.709 Gamut Warning" function is automatically set to "Off".
Marker	Safe Area Marker	Off On	<p>A safe area is an area that can be displayed on any type of device.</p> <p>If this function is set to "On", a frame is displayed around the safe area during video editing, etc. This allows you to visually confirm that subtitles and menus are arranged completely within the safe area.</p> <p>Note</p> <ul style="list-style-type: none"> • If "Picture Setup" (page 41) in the "Administrator Settings" menu is set to "Dual", a frame is displayed around the safe area only if the left and right screens have the same resolution. • If "Aspect Marker" is set to any setting other than "Off", the safe area setting is automatically set to "Off".
	Safe Area Size	80 % to 99 %	You can set the size of the safe area.

Function		Adjustable Range	Description
Marker	Aspect Marker	Off Marker 1 Marker 2	<p>A frame that supports the aspect ratios for video sizes that are regulated by digital cinema is displayed.</p> <ul style="list-style-type: none"> • "Off" No aspect marker is displayed. • "Marker 1" An outer frame is displayed. • "Marker 2" An outer frame and borderlines resulting from trisection are displayed. This setting can be used to check the composition of an image. <p>Note</p> <ul style="list-style-type: none"> • This can be set when either of the following conditions is satisfied: <ul style="list-style-type: none"> - "Picture Setup" (page 41) in the "Administrator Settings" menu is set to "Single", and the display resolution is 2048 × 1080 or 4096 × 2160. - "Picture Setup" (page 41) in the "Administrator Settings" menu is set to "Dual", the left and right screens have the same resolution, and the combined resolution is that of 4K signal (4096 × 2160 or 2048 × 1080). • The left and right outer frames are not displayed for a 4096 × 2160 signal. • If "Safe Area Marker" is set to "On", Aspect Marker is automatically set to "Off".
	Aspect Settings	1.85:1 2.35:1 2.39:1	You can set the aspect ratio for the displayed aspect marker.
	Border Color	White Red Green Blue Cyan Magenta Yellow Gray	<p>You can set the color of the frame.</p> <p>Note</p> <ul style="list-style-type: none"> • This setting applies to both "Safe Area Marker" and "Aspect Marker".

● Preferences

The monitor's settings can be configured to suit the usage environment or personal preference.

Preferences		
Menu Rotation	[0°]
USB CHARGE Port	[Normal]
Power Save	[On]
Off Timer	[15h]
Indicator	[4]
Beep	[On]
Input Skip		
Mode Skip		
Custom Key		
Monitor Reset		

Function	Adjustable Range	Description
Menu Rotation	0° 90°	This function allows you to change the orientation of the Setting menu to align with the installation orientation. Note <ul style="list-style-type: none"> When using the monitor screen in a portrait position, the graphics board supporting portrait display is required. When placing the monitor in a portrait position, settings of your graphics board need to be changed. Refer to the User's Manual of the graphics board for details. When using the monitor in the portrait orientation, you must replace the supplied stand with an arm or similar equipment.
USB CHARGE Port	Normal Charging Only	The USB downstream  port of the monitor supports USB 3.0 quick charging. By changing this setting to "Charging Only", devices connected to the  port can be charged more quickly than when using the "Normal" setting. Note <ul style="list-style-type: none"> Make sure to complete any communication between connected USB devices and the PC before switching this setting. When the setting is switched, all communication will be temporarily interrupted. Devices that are connected to the  port must support quick charging. When "Charging Only" is set, data communications between the PC and connected devices via the  port are not possible, and therefore, connected devices will not work. When "Charging Only" is set, charging is possible even when the monitor and PC are not connected by USB cable.

Function		Adjustable Range	Description
Power Save		On Off	<p>This function allows you to set the monitor to the power saving mode, depending on the state of an external device connected to it.</p> <p>The monitor changes to power saving mode about 15 seconds after signal input ceases to be detected. When the monitor has shifted to power saving mode, images are not displayed on the screen.</p> <ul style="list-style-type: none"> Exiting power saving mode <ul style="list-style-type: none"> If the monitor receives input, it automatically exits power saving mode and returns to the normal display mode. <p>Note</p> <ul style="list-style-type: none"> At the time of shifting to power saving mode, a message that indicates the transition is displayed 5 seconds in advance. When you are not using the monitor, turn off the main power switch to cut down on power consumption. When the monitor is in power saving mode, devices connected to the USB downstream port will still work. Therefore, power consumption of the monitor varies depending on the connected devices, even in the power saving mode.
Off Timer		Off 6h 9h 12h 15h 18h	<p>You can set the time for the monitor's power to automatically turn off. The monitor will automatically turn off when the time set here elapses after the monitor is turned on, or after the monitor wakes up from Power Save.</p> <p>Note</p> <ul style="list-style-type: none"> One minute before the Off Timer function is triggered, a message is displayed to notify you that the monitor's power will be turned off. Only the power switch can be operated while this message is displayed.
Indicator		Off 1 to 7	The brightness of the power switch and the operation switches when the screen is displayed can be set.
Beep		On Off	You can set the beep that sounds each time a switch is operated.
Input Skip		Skip -	<p>This function allows skipping of input signals that will not be used when the input signals are switched.</p> <p>Note</p> <ul style="list-style-type: none"> Not all input signals can be set to "Skip".
Mode Skip		Skip -	<p>This function allows skipping of modes that will not be used when selecting modes. Please use this function if display modes are limited, or if you want to prevent randomly changing the display status.</p> <p>Note</p> <ul style="list-style-type: none"> Not all modes can be set to "Skip".
Custom Key	[F1] [F2]	Off Input Range Zoom BT.709 Gamut Warning Luminance Warning Safe Area Marker Aspect Marker Prev. Color Mode Information PQ / HLG Clipping	<p>You can set the function that is assigned to the [F1] or [F2] switch.</p> <p>Note</p> <ul style="list-style-type: none"> By default, the [F1] switch is set to the "Luminance Warning" function and the [F2] switch is set to the "Information" function. Regarding the custom keys, see "Chapter 4 Custom Key Settings" (page 19).

Function	Adjustable Range	Description
Monitor Reset	Cancel OK	Restores all settings to their default values, except for the settings in the "Administrator Settings" menu.

● Languages

The display language for menus and messages can be selected.

Adjustable Range

English, Deutsch, Français, Español, Italiano, Svenska, Japanese, Simplified Chinese, Traditional Chinese



● Information

You can check the monitor information (model name, serial number (S/N), firmware version, usage time) and the input signal information.

Example:

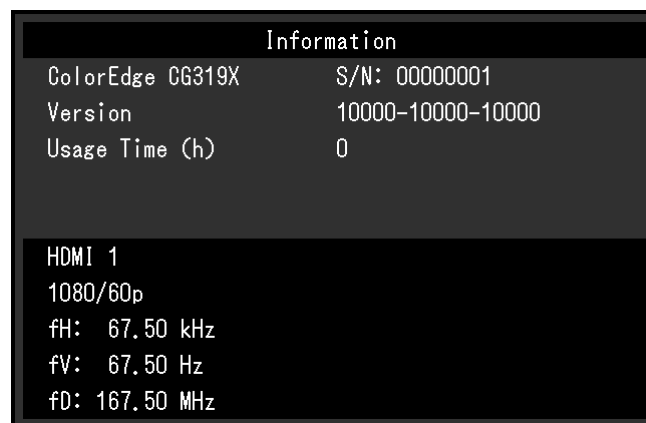

Chapter 6 Administrator Settings

This chapter describes how to configure monitor operation using the "Administrator Settings" menu. This menu is for administrators. Configuration on this menu is not required for normal monitor use.

6-1. Basic Operation of the "Administrator Settings" Menu

1. Menu display

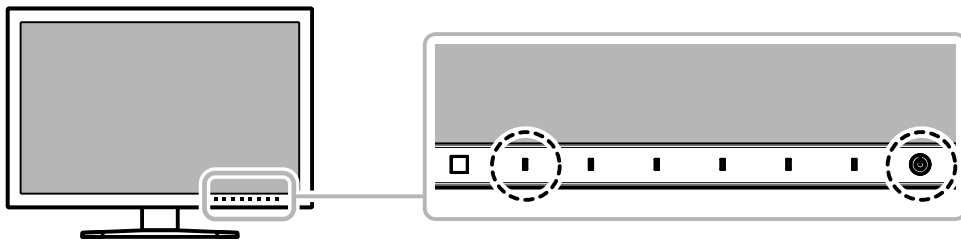

1. Touch  to turn off the monitor.
2. While touching the leftmost switch, touch  for more than 2 seconds to turn on the monitor.

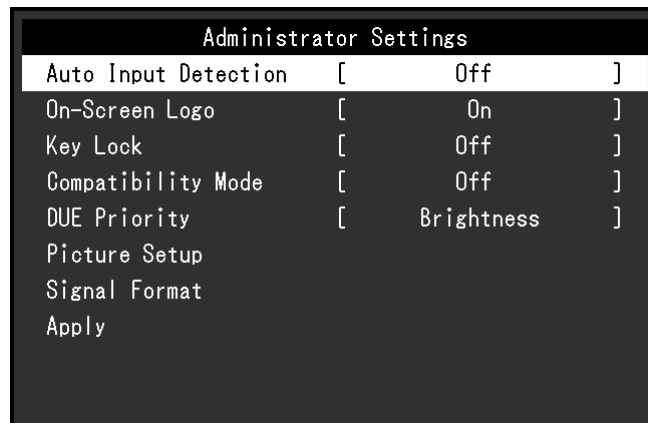

The "Administrator Settings" menu appears.



2. Setting

1. Choose an item to set with  , and then select .
- The Adjustment/Setting menu appears.

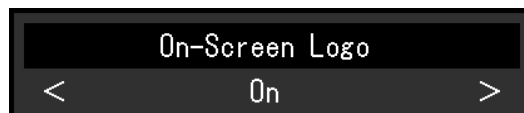



2. Set the item with  , and then select .
- The "Administrator Settings" menu appears.

3. Applying and exiting

1. Select "Apply", and then select .
- The settings are confirmed and the "Administrator Settings" menu quits.

6-2. "Administrator Settings" Menu Functions



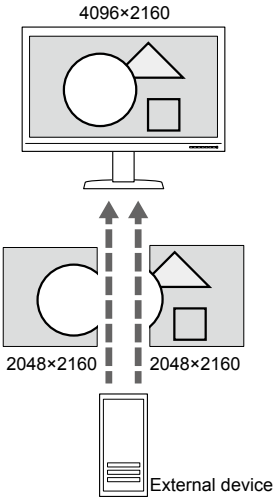
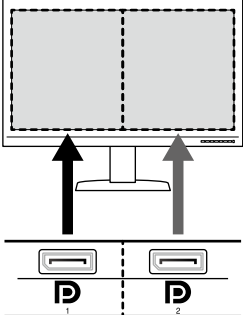

Function	Adjustable Range	Description
Auto Input Detection	Off On	<p>When this function is set to "On", the monitor automatically recognizes the connector through which signals are input, so that the screen can be displayed. If the input signal for the selected connector is lost, the monitor automatically switches to a different signal.</p> <p>When set to "Off", the monitor displays the signal from the selected connector regardless of whether a signal is input or not. In this case, select the input signal to display using the operation switch () on the front of the monitor.</p>
On-Screen Logo	Off On	When this function is set to "Off", the EIZO logo that is displayed when the monitor is turned on does not appear.
Key Lock	Off Menu All	<p>In order to prevent changes to settings, the operation switches on the front of the monitor can be locked.</p> <ul style="list-style-type: none"> • "Off" (Default setting) Enable all switches. • "Menu" Lock the  switch. • "All" Lock all switches except the power switch.
Compatibility Mode	Off On	<p>To avoid the following effects, set this function to "On".</p> <ul style="list-style-type: none"> • When you switch the monitor's power back on or return from power saving mode, windows or icons may have shifted position. • The PC's power save function does not operate correctly.
DUE Priority	Uniformity Brightness	<p>This product is equipped with a Digital Uniformity Equalizer (DUE) function that reduces display unevenness. This DUE setting can be changed.</p> <ul style="list-style-type: none"> • "Uniformity" Prioritizes reduction of display unevenness. • "Brightness" Prioritizes high brightness and high contrast. <p>Note</p> <ul style="list-style-type: none"> • When changing the DUE setting, the monitor whose display is adjusted must be re-calibrated. Perform the calibration and, if necessary, correlation again using ColorNavigator 6 or ColorNavigator NX. • For details, refer to the ColorNavigator 6 User's Manual.

Function		Adjustable Range	Description
Picture Setup	DisplayPort	Single Dual	<p>To input two separate signals from a single external device into the monitor, and view the side-by-side on the left and right sides of the screen, change this setting to "Dual".</p> <p>For example, if your graphics board does not support a 4K (4096 × 2160) signal output, you can use this setting to display two 2048 × 2160 side-by-side on a 4K screen.</p>  <p style="text-align: center;">4096×2160</p> <p style="text-align: center;">2048×2160 2048×2160</p> <p style="text-align: right;">External device</p> <p>Note</p> <ul style="list-style-type: none"> For a "Dual" display, the signal that is input to DisplayPort 1 is displayed on the left side of the screen, and the signal that is input to DisplayPort 2 is displayed on the right side.  <ul style="list-style-type: none"> The resolutions that are supported for the "Dual" setting are shown below. 640×480 / 720×400 / 800×600 / 1024×768 / 1280×960 / 1280×1024 / 1600×1200 / 1920×1080 / 1920×1200 / 1920×2160 / 2048×2160 When using "Dual" display, the connector settings of the screen on the left, such as the Color setting, will be applied.
	HDMI 1 HDMI 2	4K 30Hz 4K 60Hz 4K 60Hz Extra	<p>You can switch the signal type that the monitor can display. Try changing this setting if the input signal is not displayed, or if the displayed image does not appear correctly.</p> <p>Note</p> <ul style="list-style-type: none"> The default setting for 4K 30Hz and 4K 60Hz Extra is 1920 × 1080. When using 4K resolution, resolution settings of your OS need to be changed.

Chapter 7 Troubleshooting

7-1. No Picture

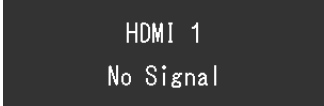
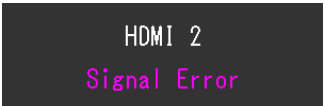
Problem	Possible cause and remedy
<p>1. No picture</p> <ul style="list-style-type: none"> Power indicator does not light up. <hr/> <ul style="list-style-type: none"> Power indicator is lighting white. <hr/> <ul style="list-style-type: none"> Power indicator is lighting orange. <hr/> <ul style="list-style-type: none"> Power indicator is flashing orange and white. 	<ul style="list-style-type: none"> Check whether the power cord is connected properly. Turn on the main power switch on the rear side of the monitor. Touch . Turn off the main power switch on the rear side of the monitor, and then turn it on again a few minutes later. <hr/> <ul style="list-style-type: none"> Increase "Brightness" and/or "Gain" in the Setting menu (see "Color" (page 25)). <hr/> <ul style="list-style-type: none"> Switch the input signal. Move the mouse or press any key on the keyboard. Check whether the external device is turned on. Turn off the main power switch on the rear side of the monitor, and then turn it on again. If the external device is using a DisplayPort connection, try changing the DisplayPort version in the next procedure. <ol style="list-style-type: none"> Touch  to turn off the monitor. While touching the leftmost switch, touch  for more than 2 seconds. The "Administrator Settings" menu appears. Select "Signal Format". Change the DisplayPort version to 1.1. Select "Apply", and then select <input checked="" type="checkbox"/>. <hr/> <ul style="list-style-type: none"> This problem may occur when an external device is connected via the DisplayPort connector. Connect via the signal cable specified by EIZO, turn off the monitor, and then turn it on again.
<p>2. The message below appears.</p> <ul style="list-style-type: none"> This message appears when no signal is input. <p>Example: </p> <hr/> <ul style="list-style-type: none"> The message shows that the input signal is out of the frequency specification range. <p>Example: </p>	<p>This message appears when the signal is not input correctly even though the monitor is functioning properly.</p> <hr/> <ul style="list-style-type: none"> The message shown left may appear, because some external devices do not output the signal immediately after power-on. Check whether the external device is turned on. Check whether the signal cable is connected properly. Switch the input signal. Turn off the main power switch on the rear side of the monitor, and then turn it on again. Try changing "Signal Format" in the "Administrator Settings" menu (see "Signal Format" (page 41)). <hr/> <ul style="list-style-type: none"> Check whether the external device is configured to meet the resolution and vertical scan frequency requirements of the monitor. For details, refer to the list of compatible resolutions. (The list is available for download from our web site (www.eizoglobal.com)). Reboot the external device. Change to the appropriate setting using the graphics board's utility. Refer to the User's Manual of the graphics board for details.

7-2. Imaging Problems

Problem	Possible cause and remedy
1. The screen is too bright or too dark.	<ul style="list-style-type: none"> Use "Brightness" in the Setting menu to adjust it (see "Color" (page 25)). The LCD monitor backlight has a limited life span. If the screen becomes dark or begins to flicker, contact your local EIZO representative.
2. Afterimages appear	<ul style="list-style-type: none"> Afterimages are particular to LCD monitors. Avoid displaying the same image for a long time. Use the screen saver or power saving function to avoid displaying the same image for extended periods of time.
3. Green/red/blue/white dots remain on the screen / Defective dots remain on the screen	<ul style="list-style-type: none"> This is due to LCD panel characteristics and not a malfunction.
4. Interference patterns or pressure marks remain on the screen.	<ul style="list-style-type: none"> Display a white or black image over the entire screen. The symptom may disappear.
5. Noise appears on the screen.	<ul style="list-style-type: none"> When inputting HDCP system signals, normal images may not be displayed immediately.
6. When you switch the power back on or return from power saving mode, windows or icons may have shifted position.	<ul style="list-style-type: none"> In the "Administrator Settings" menu, set "Compatibility Mode" to "On" (see "Compatibility Mode" (page 40)).
7. (DisplayPort / HDMI input) The screen colors look strange.	<ul style="list-style-type: none"> Try changing "Input Color Format" in the Setting menu (see "Input Color Format" (page 23)). For HDMI signal input, try changing "Signal Format" in the "Administrator Settings" menu (see "Signal Format" (page 41)).
8. The image does not display on the entire screen.	<ul style="list-style-type: none"> Try changing "Picture Expansion" in the Setting menu (see "Picture Expansion" (page 31)). Try changing "Signal Format" in the settings menu (see "Signal Format" (page 41)). Is the resolution set to the recommended resolution (4096 x 2160)? For details on the settings, refer to the User's Manual of the graphics board. Depending on the graphics board, it may not be possible to output 4K resolution (4096 x 2160 or 3840 x 2160). Check the specifications of the graphics board. If the image is displayed on only half the screen, check whether "Dual" is not selected in "Picture Setup" (page 41) in the "Administrator Settings" menu.

7-3. SelfCalibration Problems

Problem	Possible cause and remedy
1. The built-in calibration sensor does not come out/stays out.	<ul style="list-style-type: none"> Turn off the main power, and then turn it on again a few minutes later.
2. SelfCalibration cannot be executed.	<ul style="list-style-type: none"> Check whether a color mode for executing SelfCalibration has been set (see "Mode Settings" (page 15)). Check whether the date and time are set correctly on the monitor (see "Clock Adjustment" (page 16)). Check whether the execution schedule been set (see "Schedule" (page 15)). Check whether the calibration targets are set correctly (see "Target Settings" (page 29)). Try calibrating the monitor by using ColorNavigator 6 or ColorNavigator NX.
3. SelfCalibration failure	<ul style="list-style-type: none"> Refer to the error code table. If an error code that does not appear in the error code table is displayed, contact your local EIZO representative.
4. SelfCalibration is canceled while in progress.	<ul style="list-style-type: none"> If there is a change in the video signal from the external device during SelfCalibration (the signal disappears, a signal is input during a no-signal state, or other), SelfCalibration is canceled. Prevent any changes in the video signal while executing SelfCalibration. If a scheduled SelfCalibration is canceled, it is executed again when the monitor transitions to the power saving mode after an hour or more or when the monitor is turned off using . SelfCalibration can also be executed regardless of the schedule (see "3-2. Executing" (page 17)).

Error Code Table

If an error related to any of the following values occurs, the error code and error message are displayed in the "Color" menu.

- Calibration target value
- Adjustable brightness range
- Adjustable black level range

Error Code	Error Message
000020	The sensor failed to open. Check whether there is any foreign object near the sensor.
000021	The sensor failed to open. Check whether there is any foreign object near the sensor.
010141	Invalid target value has been set. Check the target value.
****52	The target black level is too low. Up the target black level or set "Min".

7-4. Other Problems

Problem	Possible cause and remedy
1. The Setting menu/Mode menu cannot be displayed	<ul style="list-style-type: none"> • Check whether the operation switch lock function works (see “Key Lock” (page 40)). • Control switches are locked when the main window of ColorNavigator 6 or ColorNavigator NX is displayed. Exit the software.
2. The monitor connected with the USB cable is not detected. / The peripheral USB device connected to the monitor does not work.	<ul style="list-style-type: none"> • Check whether the USB cable is connected correctly (see “8-5. Making Use of the USB Hub Function” (page 51)). • If a peripheral device is connected to the  port, try checking the “USB CHARGE Port” setting (see “USB CHARGE Port” (page 36)). If it is set to “Charging Only”, the peripheral device will not work. • Try changing to a different USB port on the external device. • Try changing to a different USB port on the monitor. • Reboot the external device. • If the peripheral devices work correctly when the external device and peripheral devices are connected directly, contact your local EIZO representative. • Check whether the external device and OS are USB compliant. (For USB compliance of the respective devices, consult their manufacturers.) • Depending on the USB 3.0 host controller that you are using, connected USB devices may not be recognized correctly. Update to the latest USB 3.0 driver provided by each manufacturer, or connect the monitor to the USB 2.0 port. • Check the external device's BIOS setting for USB when using Windows. (Refer to the User's Manual of the external device for details.)
3. Audio is not output.	<ul style="list-style-type: none"> • This monitor does not support DisplayPort / HDMI audio signals.

Chapter 8 Reference

8-1. Removing the Stand

The stand section of this product can be removed.

Attention

- Do not move the removed stand up and down. Doing so may result in injury or equipment damage.
- The monitor and stand are heavy. Dropping them may result in injury or equipment damage.

1. To prevent damaging the panel surface, lay the monitor with its panel surface facing down on a soft cloth spread on a stable surface.

2. Remove the stand.

Press and hold the lock button (1), firmly grip the stand support, and then slide the stand in the direction of the base of the stand (2).

When the tab that holds the stand in place loosens, remove the stand (3).

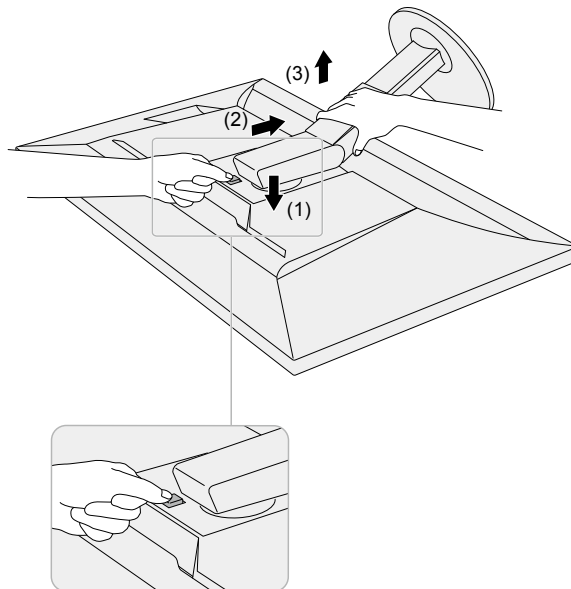

8-2. Attaching the Optional Arm

An optional arm (or an optional stand) can be attached by removing the stand section. Please refer to our web site for the corresponding optional arm (or optional stand). www.eizoglobal.com

Attention

- When attaching an arm or stand, follow the instructions of their User's Manual.
- When using another manufacturer's arm or stand, confirm the following in advance and select one conforming to the VESA standard. Use the VESA mounting screws supplied with this product when attaching the arm or stand.
 - Clearance between screw holes: 100 mm x 100 mm
 - Plate thickness: 2.6 mm
 - Must be strong enough to support weight of the monitor unit (excluding the stand) and attachments such as cables.
- When using an arm or stand, attach it to meet the following tilt angles of the monitor.
 - Up 45°, down 45°
- Connect the cables after attaching an arm or stand.
- The monitor, arm, and stand are heavy. Dropping them may result in injury or equipment damage.
- When installing the monitor in portrait mode, turn the monitor screen 90° in clockwise direction.

Attaching the Optional Arm (or Optional Stand)

1. Attach the arm or stand to the monitor.

Use the VESA mounting screws supplied with this product when attaching the arm or stand.

Attaching the Original Stand

1. To prevent damaging the panel surface, lay the monitor with its panel surface facing down on a soft cloth spread on a stable surface.

2. Remove the fixing screws on the optional arm (or optional stand), and detach the optional arm (or optional stand).

3. Attach the original stand.

Insert the four tabs on the stand into the square holes on the back panel (1) and slide the stand towards the upper portion of the monitor until it makes a clicking sound (2).

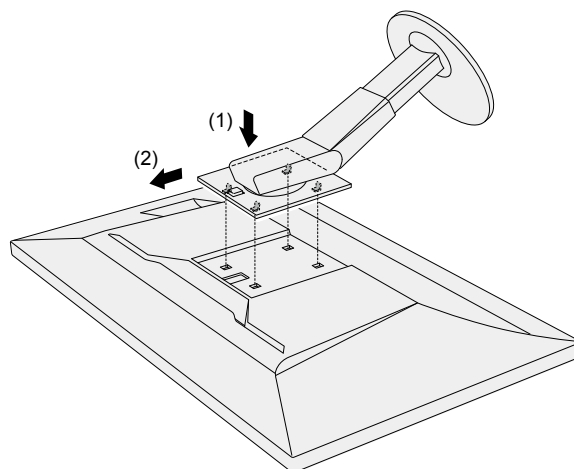

8-3. Attaching/Detaching the Cable Holder

A cable holder is supplied with this product. Use the cable holder to organize the cables connected to the monitor.

Attachment procedure

1. Pass the cables through the cable holder.
2. Close the cable holder.

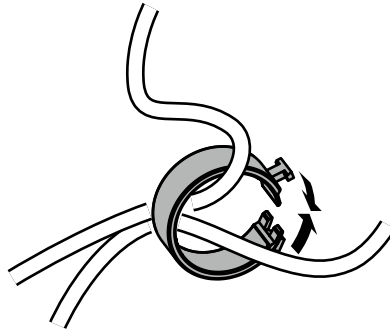

3. In this state, insert the cable holder into the stand.

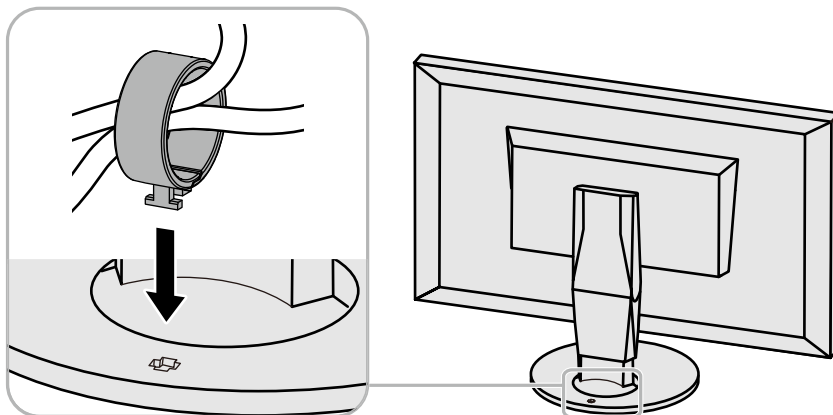

Note

- The cable holder can be inserted either perpendicular or parallel to the stand. Change the orientation of the cable holder in line with the direction of the cables.

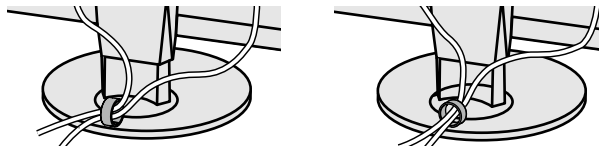

Detachment procedure

- 1.** Close the cable holder.
- 2.** In this state, pull the cable holder from the stand.

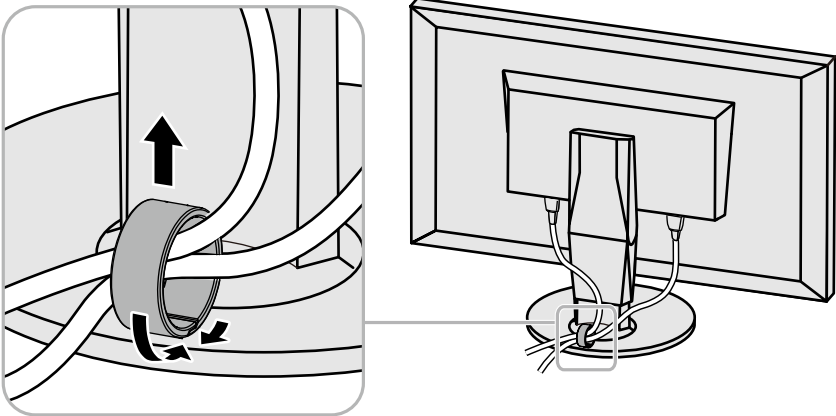

8-4. Connecting Multiple External Devices

The product allows you to connect multiple external devices and switch between them for display.

Connection examples

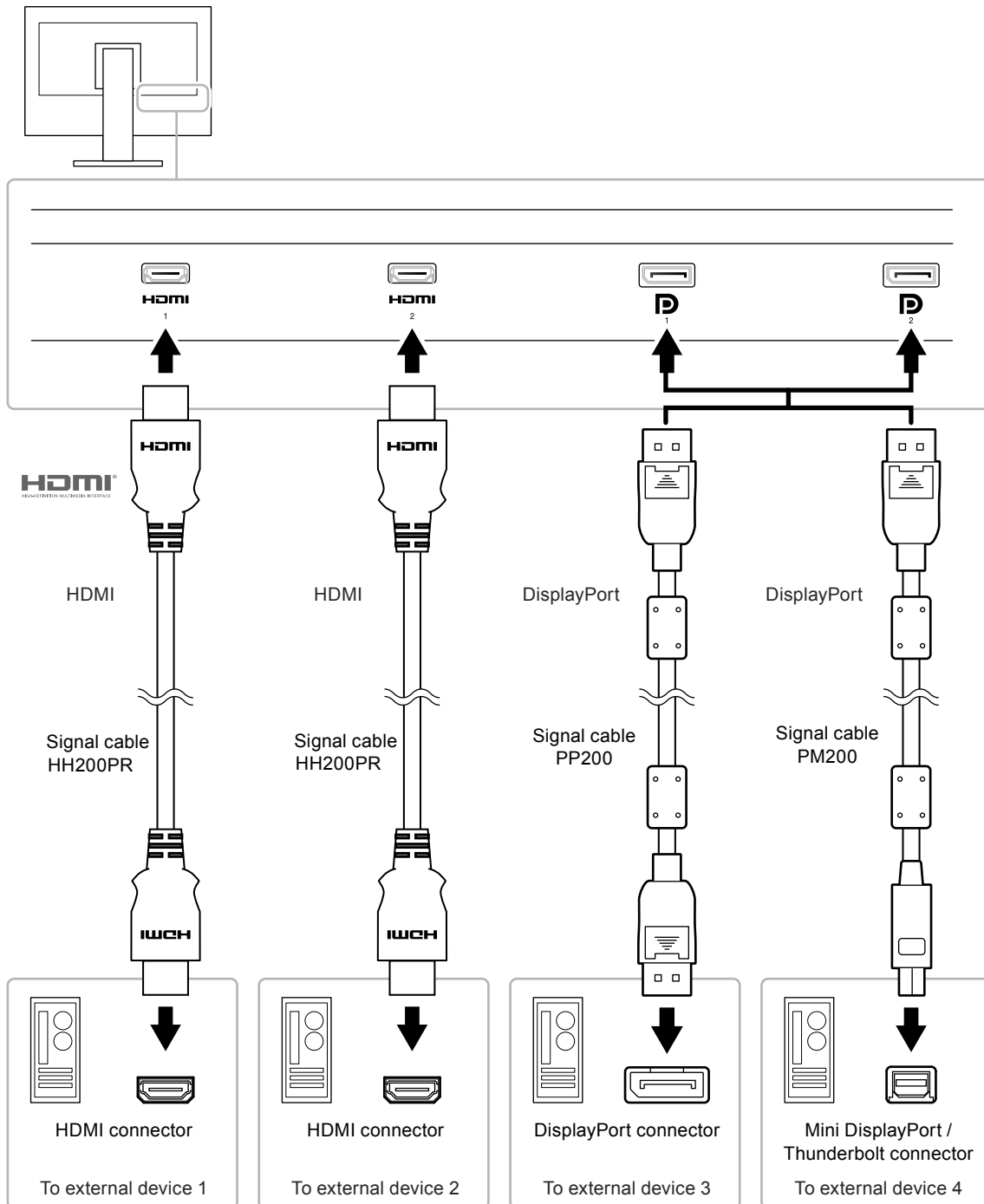

Note

- The input signal changes each time the operation switch () on the front of the monitor is touched. For more information, see "2-2. Switching Input Signals" (page 12).
- The connector through which signals are input is recognized automatically, and images are displayed on the screen accordingly. For more information, see "Auto Input Detection" (page 40).

8-5. Making Use of the USB Hub Function

This monitor is equipped with a USB hub. It works as a USB hub when connected to a USB-compatible external device, allowing the connection of peripheral USB devices.

● Connection Procedure

1. Connect the USB cable between the USB downstream port of the external device and USB upstream port of the monitor.

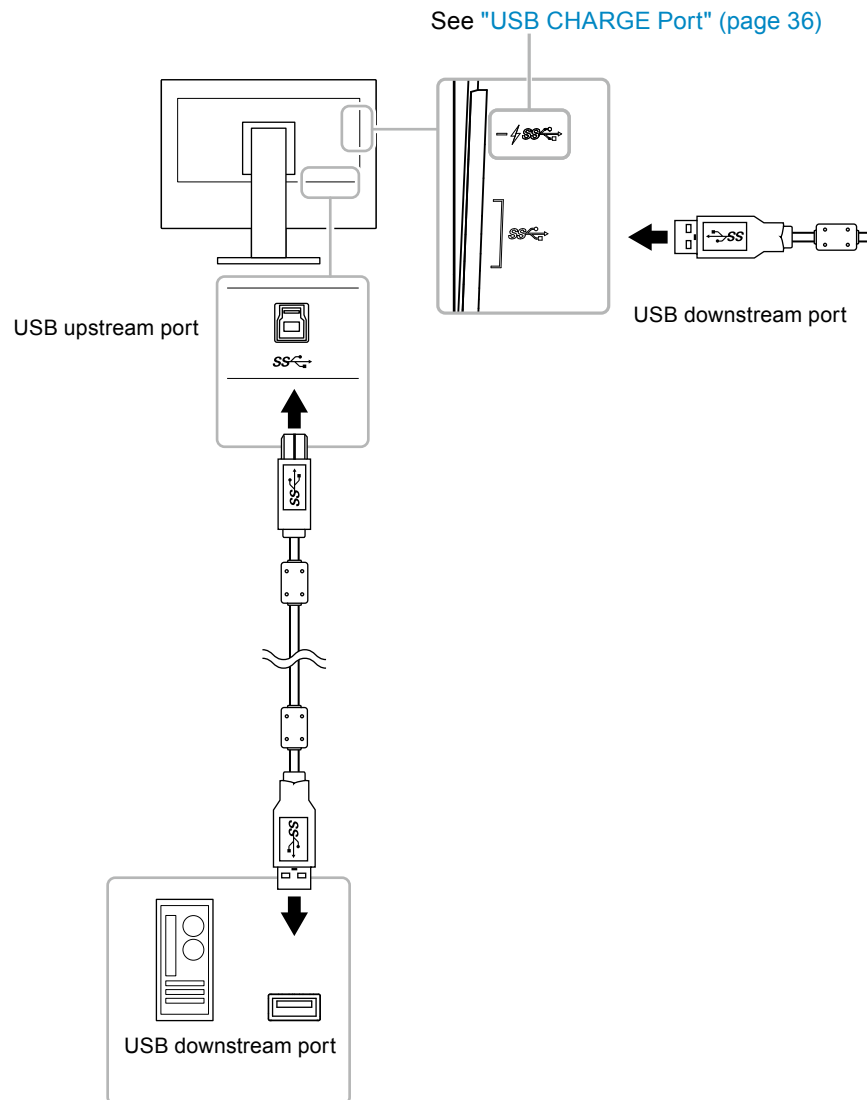

2. Connect the peripheral USB device to the USB downstream port of the monitor.



Attention

- This monitor may not work depending on the used external device, OS or peripheral devices. For USB compatibility of peripheral devices, contact their manufactures.
- When the monitor is in power saving mode, devices connected to the USB downstream port will still work. Therefore, power consumption of the monitor varies depending on the connected devices, even in the power saving mode.
- When the main power switch of the monitor is off, a device connected to the USB downstream port will not operate.
- When the "USB CHARGE Port" setting in "Preferences" is set to "Charging Only", a peripheral device will not work if connected to the  port.
- Ensure that communication between all peripheral devices connected to the monitor and the external device is ended before switching the "USB CHARGE Port" setting. When the setting is switched, all communication will be temporarily interrupted.

Note

- This product supports USB 3.0. When connecting peripheral devices that support USB 3.0, high-speed data communication is possible (however, only when the USB cable used to connect the external device and peripheral device is USB 3.0 compliant).
 - The  USB downstream port also supports quick charging. This allows you to recharge your smartphone or tablet in a short period of time. (See "[USB CHARGE Port](#)" (page 36))
-

8-6. Specifications

LCD Panel	Type	IPS (Anti-Glare)
	Backlight	Wide color gamut LED
	Size	78.9 cm (31.1 inch) (78.9 cm diagonal)
	Resolution	4096 dots × 2160 lines
	Display Size (H × V)	698.0 mm × 368.1 mm
	Pixel Pitch	0.170mm × 0.170mm
	Pixel Density	149ppi
	Display Colors	Approx. 1073.74 million colors (for 10 bit input)
	Viewing Angle (H × V, typical)	178° / 178°
	Contrast Ratio (typical)	1500:1 (When "DUE priority" setting is "Brightness")
	Response Time (typical)	Black → White → Black: 20 ms Gray-to-gray: 9ms
	Color Gamut Display (typical)	Adobe®RGB coverage: 99 %, DCI-P3 coverage: 98 %
Video Signals	Input Terminals	DisplayPort 1.2 (HDCP 1.3 compatible) × 2, HDMI (HDCP 2.2/1.4, Deep Color compatible) *1 × 2 *1 Not compatible with HDMI CEC function (mutual control function).
	Horizontal scan frequency	DisplayPort: 25 kHz to 137 kHz HDMI: 15 kHz to 136 kHz
	Vertical scan frequency	DisplayPort: 23 Hz to 61 Hz (For 720 x 400: 69 Hz to 71 Hz) HDMI: 23 Hz to 61 Hz (For 720 x 400: 69 Hz to 71 Hz)
	Frame Synchronization mode	23.75 Hz to 30.25 Hz, 47.5 Hz to 60.5 Hz
	Dot clock (Max.)	DisplayPort: 598.3 MHz HDMI: 600MHz
USB	Port	Upstream port × 1 Downstream port × 3 (The  port supports quick charging.)
	Standard	USB Specification Rev. 3.0 USB Battery Charging Specification Rev.1.2
	Communication Speed	5 Gbps (super), 480 Mbps (high), 12 Mbps (full), 1.5 Mbps (low)
	Supply Current	Downstream: Max. 900 mA per port Downstream ( port): Normal: Max. 1.5 A per port, Charging Only: Max. 2.1 A per port
Power	Input	100-240 VAC ±10 %, 50/60 Hz 1.45 A-0.65 A
	Maximum Power Consumption	140 W or less
	Power Save Mode	1.2 W or less (When "Compatibility Mode" is set to "Off", no USB device is connected, "Auto Input Detection" is set to "Off", and no USB upstream port is connected)
	Standby Mode	1.2 W or less (When "Compatibility Mode" is set to "Off", no USB device is connected, and no USB upstream port is connected)

Physical Specifications	Outside Dimensions	Minimum Height	735 mm × 434.0 mm × 290 mm (W × H × D) (Tilt: 0°)
		Maximum Height	735 mm × 595.9 mm × 307 mm (W × H × D) (Tilt: 35°)
	Outside Dimensions (Without Stand)		735 mm × 423 mm × 71.5 mm (W × H × D)
	Net. weight		Approx. 12.4 kg
	Net Weight (Without Stand)		Approx. 8.3 kg
	Height adjustment		154 mm (at tilt of 0°) / 155 mm (at tilt of 35°)
	Tilt		Up 35°, down 5°
	Swivel		344°
Operating Environment Requirements	Temperature		0°C to 35°C (landscape orientation) / 0°C to 30°C (portrait orientation*2) *2 When using the monitor in the portrait orientation, you must replace the supplied stand with an arm or similar equipment.
	Humidity		20 % to 80 % R.H. (no condensation)
	Air Pressure		540 hPa to 1060 hPa
Transportation/ Storage Environment Requirements	Temperature		-20 °C to 60 °C
	Humidity		10 % to 90 % R.H. (no condensation)
	Air Pressure		200 hPa to 1060 hPa

● Accessories

Signal cable	PP200 (DisplayPort - DisplayPort) PM200 (Mini DisplayPort - DisplayPort) HH200PR (HDMI - HDMI)
--------------	--

For the latest information about the accessories, refer to our web site. www.eizoglobal.com

Appendix

Trademark

The terms HDMI and HDMI High-Definition Multimedia Interface, and the HDMI Logo are trademarks or registered trademarks of HDMI Licensing, LLC in the United States and other countries.

The DisplayPort Compliance Logo and VESA are registered trademarks of the Video Electronics Standards Association.

The SuperSpeed USB Trident Logo is a registered trademark of USB Implementers Forum, Inc.



The USB Power Delivery Trident Logos are trademarks of USB Implementers Forum, Inc.



DICOM is the registered trademark of the National Electrical Manufacturers Association for its standards publications relating to digital communications of medical information.

Kensington and Microsaver are registered trademarks of ACCO Brands Corporation.

Thunderbolt is a trademark of Intel Corporation in the United States and/or other countries.

Microsoft and Windows are registered trademarks of Microsoft Corporation in the United States and other countries.

Adobe is a registered trademark of Adobe Systems Incorporated in the United States and other countries.

Apple, macOS, Mac OS, OS X, Macintosh and ColorSync are registered trademarks of Apple Inc.

EIZO, the EIZO Logo, ColorEdge, CuratOR, DuraVision, FlexScan, FORIS, RadiCS, RadiForce, RadiNET, Raptor and ScreenManager are registered trademarks of EIZO Corporation in Japan and other countries.

ColorEdge Tablet Controller, ColorNavigator, EcoView NET, EIZO EasyPIX, EIZO Monitor Configurator, EIZO ScreenSlicer, G-Ignition, i•Sound, Quick Color Match, RadiLight, Re/Vue, SafeGuard, Screen Administrator, Screen InStyle, ScreenCleaner and UniColor Pro are trademarks of EIZO Corporation.

All other company and product names are trademarks or registered trademarks of their respective owners.

License

The bitmap font used for this product is designed by Ricoh Industrial Solutions Inc.

FCC Declaration of Conformity

For U.S.A., Canada Only

FCC Declaration of Conformity

We, the Responsible Party

EIZO Inc.

5710 Warland Drive, Cypress, CA 90630

Phone: (562) 431-5011

declare that the product

Trade name: EIZO

Model: ColorEdge CG319X

is in conformity with Part 15 of the FCC Rules. Operation of this product is subject to the following two conditions: (1) this device may not cause harmful interference, and (2) this device must accept any interference received, including interference that may cause undesired operation.

This equipment has been tested and found to comply with the limits for a Class B digital device, pursuant to Part 15 of the FCC Rules. These limits are designed to provide reasonable protection against harmful interference in a residential installation. This equipment generates, uses, and can radiate radio frequency energy and, if not installed and used in accordance with the instructions, may cause harmful interference to radio communications. However, there is no guarantee that interference will not occur in a particular installation. If this equipment does cause harmful interference to radio or television reception, which can be determined by turning the equipment off and on, the user is encouraged to try to correct the interference by one or more of the following measures.

- * Reorient or relocate the receiving antenna.
- * Increase the separation between the equipment and receiver.
- * Connect the equipment into an outlet on a circuit different from that to which the receiver is connected.
- * Consult the dealer or an experienced radio/TV technician for help.

Changes or modifications not expressly approved by the party responsible for compliance could void the user's authority to operate the equipment.

Note

Use the attached specified cable below or EIZO signal cable with this monitor so as to keep interference within the limits of a Class B digital device.

- AC Cord
- Shielded Signal Cable (enclosed)

Canadian Notice

This Class B information technology equipment complies with Canadian ICES-003.

Cet équipement informatique de classe B est conforme à la norme NMB-003 du Canada.

