

# User's Manual

# FlexScan® S2100

## Color LCD Monitor

### Important

Please read PRECAUTIONS, this User's Manual, and the Setup Manual (separate volume) carefully to familiarize yourself with safe and effective usage.

- Please refer to the Setup Manual for basic information ranging from connection of the monitor to a PC to using the monitor.
- The latest User's Manual is available for download from our web site:  
<http://www.eizo.com>

## CONTENTS

### Chapter 1 Features and Overview

- 1-1 Features
- 1-2 Buttons and Indicators
- 1-3 Functions and Basic Operation

### Chapter 2 Settings and Adjustments

- 2-1 Utility Disk
- 2-2 Screen Adjustment
- 2-3 Color Adjustment
- 2-4 Off Timer Settings
- 2-5 Screen Size Selection
- 2-6 Power Indicator/EIZO Logo Display Setting
- 2-7 Locking Buttons
- 2-8 Setting Adjustment menu Display
- 2-9 Viewing Information/Setting Language
- 2-10 Setting BrightRegulator
- 2-11 Resumption of Default Setting

### Chapter 3 Connecting Cables

- 3-1 Connecting Two PCs to the Monitor
- 3-2 Connecting Peripheral USB Devices

### Chapter 4 Troubleshooting

### Chapter 5 Reference

- 5-1 Attaching an Arm
- 5-2 Power Saving Mode
- 5-3 Cleaning
- 5-4 Specifications
- 5-5 Glossary
- 5-6 Preset Timing



This product has acquired the TCO standard that relates to the safety, ergonomics, environment and so forth of office equipment. For an overview of the TCO, refer to our web site.  
<http://www.eizo.com>

This product has been adjusted specifically for use in the region to which it was originally shipped. If operated outside this region, the product may not perform as stated in the specifications.

---

---

No part of this manual may be reproduced, stored in a retrieval system, or transmitted, in any form or by any means, electronic, mechanical, or otherwise, without the prior written permission of EIZO Corporation.

EIZO Corporation is under no obligation to hold any submitted material or information confidential unless prior arrangements are made pursuant to EIZO Corporation's receipt of said information. Although every effort has been made to ensure that this manual provides up-to-date information, please note that EIZO monitor specifications are subject to change without notice.

---

---

VESA is a registered trademark or a trademark of the Video Electronics Standards Association in the United States and other countries. Windows, Windows Vista, Windows Media, SQL Server, and Xbox 360 are registered trademarks of Microsoft Corporation in the United States and other countries.

Apple, Mac, Macintosh, iMac, eMac, Mac OS, MacBook, PowerBook, ColorSync, QuickTime, and iBook are registered trademarks of Apple Inc.

EIZO, the EIZO Logo, ColorEdge, DuraVision, FlexScan, FORIS, RadiForce, RadiCS, RadiNET, Raptor, and ScreenManager are registered trademarks of EIZO Corporation in Japan and other countries.

All other company and product names are trademarks or registered trademarks of their respective owners.

---

## Notice for this monitor

---

---

This product is suited to general purposes like creating documents, viewing multimedia content.

---

This product has been adjusted specifically for use in the region to which it was originally shipped. If the product is used outside the region, it may not operate as specified in the specifications.

---

This product may not be covered by warranty for uses other than those described in this manual.

---

The specifications noted in this manual are only applicable when the following are used:

- Power cords provided with the product
  - Signal cables specified by us
- 

Only use optional products manufactured or specified by us with this product.

---

As it takes about 30 minutes for the performance of electrical parts to stabilize, adjust the monitor 30 minutes or more after the monitor power has been turned on.

---

Monitors should be set to a lower brightness to reduce changes in luminosity caused by long-term use and maintain a stable display.

---

When the screen image is changed after displaying the same image for extended periods of time, an afterimage may appear. Use the screen saver or power save function to avoid displaying the same image for extended periods of time.

---

Periodic cleaning is recommended to keep the monitor looking new and to prolong its operation lifetime (refer to “Cleaning” on page 24).

---

The LCD panel is manufactured using high-precision technology. Although, missing pixels or lit pixels may appear on the LCD panel, this is not a malfunction. Percentage of effective dots: 99.9994% or higher.

---

The backlight of the LCD panel has a fixed lifetime. When the screen becomes dark or begins to flicker, please contact your dealer.

---

Do not press on the panel or edge of the frame strongly, as this may result in display malfunctions, such as interference patterns, etc. If pressure is continually applied to the panel, it may deteriorate or damage your panel. (If the pressure marks remain on the panel, leave the monitor with a black or white screen. The symptom may disappear.)

---

Do not scratch or press on the panel with any sharp objects, as this may result in damage to the panel. Do not attempt to brush with tissues as this may scratch the panel.

---

When the monitor is cold and brought into a room or the room temperature goes up quickly, dew condensation may occur on the interior and exterior surfaces of the monitor. In that case, do not turn the monitor on. Instead wait until the dew condensation disappears, otherwise it may cause some damage to the monitor.

---

---

## To use the monitor comfortably

---

---

An excessively dark or bright screen may affect your eyes. Adjust the brightness of the monitor according to the environmental conditions.

---

Staring at the monitor for a long time tires your eyes. Take a 10-minute rest every hour.

---

---

# CONTENTS

Notice for this monitor .....	3	2-7 Locking Buttons .....	16
To use the monitor comfortably .....	3	• To lock operation [Adjustment Lock].....	16
<b>CONTENTS .....</b>	<b>4</b>	<b>2-8 Setting Adjustment menu Display.....</b>	<b>17</b>
<b>Chapter 1 Features and Overview .....</b>	<b>5</b>	• To update menu settings [Menu Size/Menu Position/Menu Off Timer/Translucent/ Orientation].....	17
1-1 Features .....	5	<b>2-9 Viewing Information/Setting Language .....</b>	<b>18</b>
1-2 Buttons and Indicators.....	5	• To check settings, usage time, etc. [Information] .....	18
1-3 Functions and Basic Operation.....	6	• To set a language to be displayed [Language] .....	18
<b>Chapter 2 Settings and Adjustments .....</b>	<b>8</b>	<b>2-10 Setting BrightRegulator .....</b>	<b>18</b>
2-1 Utility Disk .....	8	• To set automatic brightness adjustment [BrightRegulator] .....	18
• Disk contents and software overview .....	8	<b>2-11 Resumption of Default Setting .....</b>	<b>18</b>
• To use ScreenManager Pro for LCD .....	8	• To reset color adjustment [Reset].....	18
2-2 Screen Adjustment .....	9	• To reset all settings [Reset].....	18
Digital Input.....	9	<b>Chapter 3 Connecting Cables .....</b>	<b>19</b>
Analog Input .....	9	3-1 Connecting Two PCs to the Monitor .....	19
2-3 Color Adjustment.....	12	• To set auto-switching of input signals [Input Signal] .....	20
Simple adjustment [FineContrast mode] .....	12	3-2 Connecting Peripheral USB Devices .....	20
• FineContrast Mode.....	12	<b>Chapter 4 Troubleshooting.....</b>	<b>21</b>
• To select FineContrast mode name.....	12	<b>Chapter 5 Reference .....</b>	<b>23</b>
Advanced Adjustments [Adjustment menu].....	13	5-1 Attaching an Arm .....	23
• To select an appropriate mode for images .....	13	5-2 Power Saving Mode.....	24
• To set/adjust color .....	14	5-3 Cleaning.....	24
2-4 Off Timer Settings.....	14	5-4 Specifications .....	25
• To set monitor power-off time [Off Timer] .....	14	5-5 Glossary .....	27
2-5 Screen Size Selection.....	15	5-6 Preset Timing .....	29
• To change screen size [Screen Size] .....	15		
• To adjust brightness of non-display area [Border Intensity] .....	15		
2-6 Power Indicator/EIZO Logo Display Setting 16			
• To turn off the Power indicator while a screen is displayed [Power Indicator] .....	16		
• To display EIZO logo [EIZO Logo Appearing Function].....	16		

# Chapter 1 Features and Overview

Thank you very much for choosing an EIZO color LCD monitor.

## 1-1 Features

- Dual-input compliant (DVI-I and D-sub mini 15-pin connectors)
- DVI digital input (TMDS) compliant
- Horizontal scan frequency: Analog: 24 - 80 kHz, Digital: 31 - 76 kHz
- Vertical scan frequency: Analog: 49 - 76 Hz (1600 × 1200: 49 - 61 Hz)  
Digital: 59 - 61 Hz (VGA text: 69 - 71 Hz)  
Resolution: 1600 dots × 1200 lines
- Compatible with frame synchronization mode (59 - 61 Hz)
- Smoothing (soft - sharp) function for adjustment of enlarged images
- BrightRegulator function incorporated
- FineContrast mode to allow the best mode for screen display
- The utility software “ScreenManager Pro for LCD” (for Windows) to control the monitor from a PC with mouse/keyboard is included (refer to the EIZO LCD Utility Disk).
- Height adjustable stand
- Ultra slim bezel
- Portrait/Landscape display available

### NOTE

- This monitor supports the Portrait/Landscape display. (The panel can be turned 90 degrees clockwise.)
- The stand of the unit can be replaced with an arm or another stand. (Refer to “5-1 Attaching an Arm” on page 23.)
- Select “Portrait” for <Orientation> on <Others> menu of the Adjustment menu to turn the menu 90 degrees.

## 1-2 Buttons and Indicators

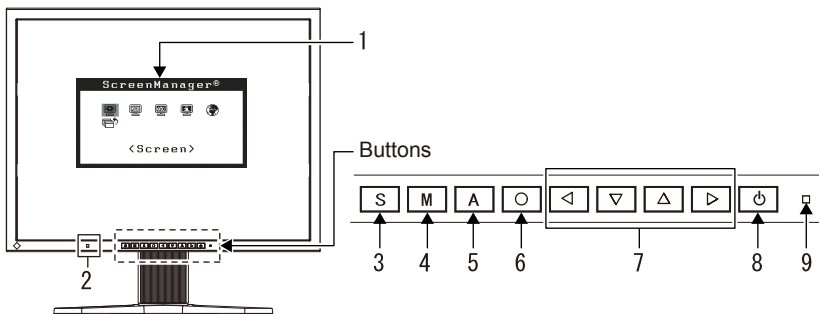

1. Adjustment menu (\*ScreenManager<sup>®</sup>)
2. Sensor (BrightRegulator)
3. Input signal selection button
4. Mode button
5. Auto adjustment button
6. Enter button
7. Control buttons (Left, Down, Up, Right)
8. Power button
9. Power indicator

### NOTE

- While a screen is displayed, the blue power indicator can be turned off (see “To turn off the Power Indicator while a screen is displayed,” on page 16).
- For the power indicator status with “Off Timer” set, refer to “To set monitor power-off time” on page 14.

Indicator status	Operation status
Blue	The screen is displayed
Yellow	Power saving
Off	Power off

\* ScreenManager<sup>®</sup> is an EIZO's nickname of the Adjustment menu.

# 1-3 Functions and Basic Operation

## To adjust the screen and color

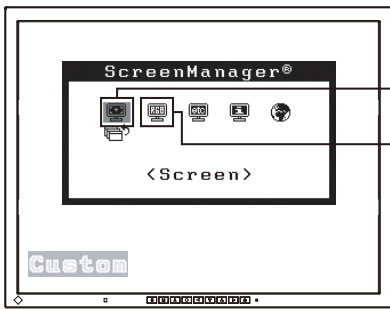

The Adjustment menu and the FineContrast mode name cannot be displayed at the same time.

**M** FineContrast mode

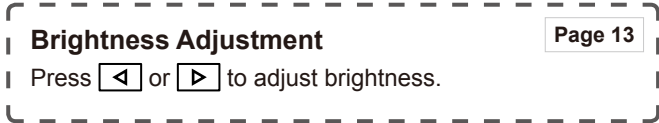
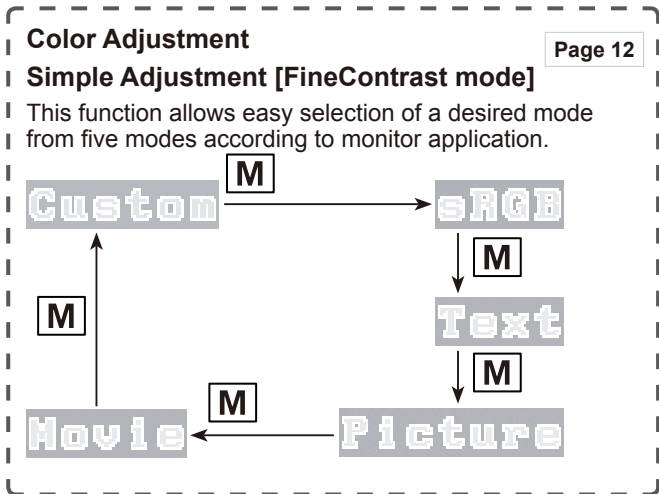

**A** Analog input only

**1 Screen Adjustment** Page 9

**(Automatic Adjustment)**

Press **A**.

Press **A** again while the message window is displayed.



**O** Adjustment menu (Refer to page 9 for operation)

**2 Screen Adjustment** Page 9

**(Advanced Adjustment)**

**[Adjustment menu]**

[At analog signal input]	[At digital signal input]
<p>&lt;Clock&gt;</p>	<p>&lt;Smoothing&gt;</p>

- To eliminate vertical bars [Clock\*] ... see page 10
- To remove flickering or blurring [Phase\*]..... see page 10
- To correct screen position [Position\*] ..... see page 10
- To adjust color gradation automatically [Range Adjustment\*] ..... see page 11
- To modify blurred characters/lines [Smoothing] ..... see page 11
- To set when a noise appears on the screen [Signal Filter\*] ..... see page 22

\* Items marked with \* can be adjusted with analog input.

**Color Adjustment** Page 13

**Advanced Adjustment [Adjustment menu]**

<Brightness>

- "Brightness," "Temperature," "Gamma," "Saturation," "Hue," and "Gain" can be set for each mode (Custom/sRGB/Text/Picture/Movie). Settable functions vary with the display mode.

**Resuming the default settings**

- To reset color adjustment [Reset] ... see page 18

## To make useful settings/adjustments

 Adjustment menu (Refer to below for operation)

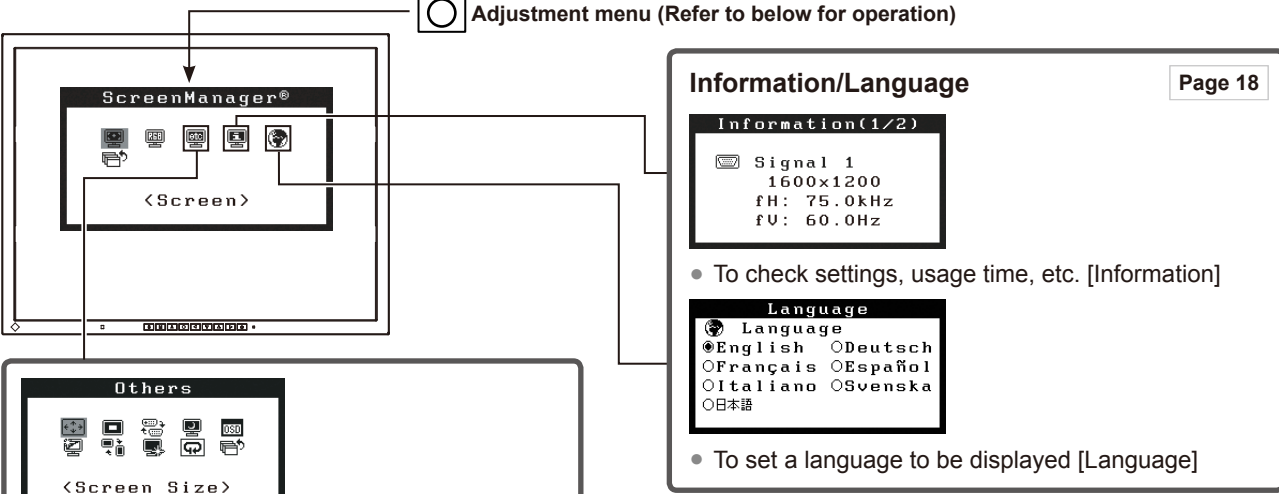

**Others**

 <Screen Size>

**Set the off timer**

- To set monitor power-off time [Off Timer] ..... see page 14

**Change the screen size**

- To change screen size [Screen Size] ..... see page 15
- To adjust brightness of non-display area [Border Intensity] ..... see page 15

**Power Indicator Setting**

- To turn off the Power indicator while a screen is displayed [Power Indicator] ..... see page 16

**Adjustment menu settings**

- To update menu settings [Menu Size/Menu Position/Menu Off Timer/Translucent/Orientation] ..... see page 17

**BrightRegulator Setting**

- To set automatic brightness adjustment [BrightRegulator] ..... see page 18

**Resume the factory default settings**

- To reset all settings [Reset] ..... see page 18

**Connect two PCs**

- To set auto-switching of input signals [Input Signal] ..... see page 20

**Information/Language** Page 18

**Information(1/2)**

Signal 1  
1600x1200  
fH: 75.0kHz  
fV: 60.0Hz

- To check settings, usage time, etc. [Information]

**Language**

Language  
 English    Deutsch  
 Francais    Español  
 Italiano    Svenska  
 日本語

- To set a language to be displayed [Language]

**Locking Adjustment**

- To lock operation [Adjustment Lock] ... see page 16

**EIZO Logo Display Setting**

















- To display EIZO logo [EIZO Logo Appearing Function] ..... see page 16

**Connecting Cables**



- Connecting Two PCs to the Monitor ... see page 19
- Connecting Peripheral USB Devices ... see page 20

## Basic operation of Adjustment menu



### [Displaying Adjustment menu and selecting function]

- Press . The main menu appears.
- Select a function with ///, and press . The sub menu appears.
- Select a function with ///, and press . The adjustment/setting menu appears.
- Adjust the selected item with ///, and press . The setting is saved.

### [Exiting Adjustment menu]

- Choose <Return> from the sub menu and press .
- Choose <Exit> from the main menu and press .

#### NOTE

- The Adjustment menu can also be exited by pressing  twice quickly.
- <Exit> or <Return> can also be selected by pressing the  button twice in the Main menu or Sub menu.

# Chapter 2 Settings and Adjustments

## 2-1 Utility Disk

An “EIZO LCD Utility Disk” (CD-ROM) is supplied with the monitor. The following table shows the disk contents and the overview of the application software programs.

### • Disk contents and software overview

The disk includes a monitor information file, application software programs for adjustment, and User’s Manual. Refer to Readme.txt file on the disk for software startup procedures or file access procedures.

Item	Overview	For Windows	For Macintosh
Readme.txt file		√	√
Screen adjustment pattern files	Used when adjusting the image of analog signal input manually.	√	√
ScreenManager Pro for LCD (for Windows)	A utility software program to control monitor adjustments from a PC using its mouse and keyboard. (A PC must be connected to the monitor with the supplied USB cable.) Refer to the description later.	√	—
WindowMovie Checker Software	WindowMovie is a function of ScreenManager Pro for LCD. For more information, refer to the User’s Manual of ScreenManager Pro for LCD on the disk.		
User’s Manual of this monitor (PDF file)			

### • To use ScreenManager Pro for LCD

For the installation and use of ScreenManager Pro for LCD, refer to its User’s Manual on the disk.

To adjust the monitor using ScreenManager Pro for LCD, connect a PC to the monitor with the supplied USB cable.

#### [Connection]

- (1) Connect the USB port (downstream) of a USB compatible PC (or other USB hub) and the monitor’s USB port (upstream) with the supplied USB cable.

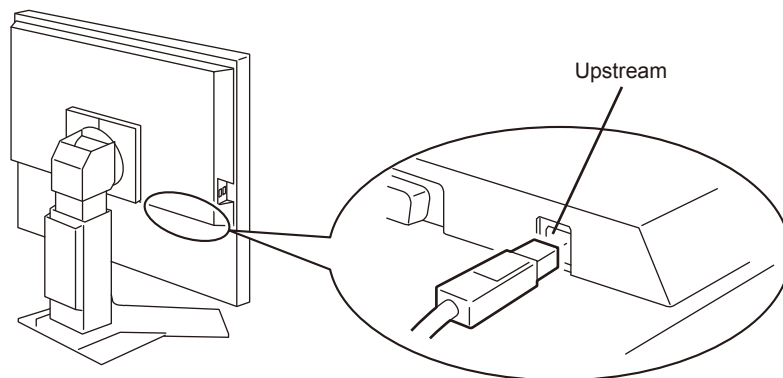

- (2) The USB function is set up automatically upon connection of the USB cable.



## 2-2 Screen Adjustment

### Digital Input

When digital signals are input, images are displayed correctly based on the preset data of the monitor.

### Analog Input

The monitor screen adjustment is used to suppress flickering of the screen or adjust screen position and screen size correctly according to the PC to be used. To use the monitor comfortably, adjust the screen when the monitor is set up for the first time or when the settings of the PC in use are updated.

#### [Adjustment Procedure]

##### • Automatic Adjustment

### 1 Press **A**.

A message “Your setting will be lost if you press again now” appears for five seconds.

### 2 Press **A** again while the message is displayed.

The Auto Adjustment function begins (showing a running status message) to adjust clock, phase, display position, and resolution automatically.

If satisfactory adjustment cannot be obtained with the **A** button, perform the adjustment following the procedure below. When the screen is displayed correctly, go to step 5 “Range Adjustment”.

##### • Advanced Adjustment

### 3 Prepare to use analog screen adjustment patterns.

Load the “EIZO LCD Utility Disk” to your PC, and then open the “Screen adjustment pattern files”.

#### Attention

- Wait 20 minutes or more from monitor power on before starting adjustments.

#### NOTE

- Auto adjustment is available using **A**. If satisfactory adjustment cannot be obtained with this button, perform advanced adjustments using the Adjustment menu.

#### Attention

- This function works correctly when an image is fully displayed over the Windows or Macintosh display area. It does not work properly when an image is displayed only on a part of the screen (DOS prompt window, for example) or when a black background (wallpaper, etc.) is in use.
- This function does not work correctly with some graphics boards.

#### NOTE

- For details and instructions on opening the “Screen adjustment pattern files”, refer to the Readme.txt file.

## 4 Perform advanced adjustments for the following using the <Screen> menu of the Adjustment menu.

### • To eliminate vertical bars [Clock]

- (1) Display Pattern 1 in full screen on the monitor using the “Screen adjustment pattern files”.



- (2) Choose <Clock> from the <Screen> menu, and press .

The <Clock> menu appears.

- (3) Adjust the clock with  or , and press .

The adjustment is completed.

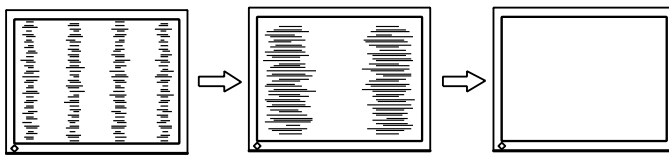

### • To remove flickering or blurring [Phase]

- (1) Choose <Phase> from the <Screen> menu, and press .

The <Phase> menu appears.

- (2) Adjust the phase with  or , and press .

The adjustment is completed.

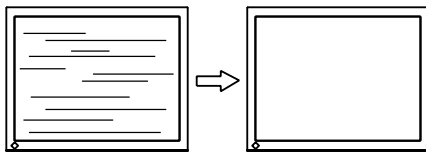

### • To correct screen position [Position]

Since the number of pixels and the pixel positions are fixed on the LCD monitor, only one position is provided to display images correctly. The position adjustment is made to shift an image to the correct position.

- (1) Choose <Position> from the <Screen> menu, and press .

The <Position> menu appears.

- (2) Adjust the position with , , , or  to display the image properly in the display area of the monitor.

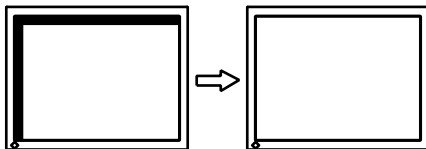

- (3) Close Pattern 1.

#### NOTE

- Press the control button slowly so as not to miss the adjustment point.
- When blurring, flickering or bars appear on the screen after adjustment, proceed to [Phase] to remove flickering or blurring.

#### Attention

- Flickering or blurring may not be eliminated depending on your PC or graphics board.

#### NOTE

- When vertical bars appear on the screen after adjustment, go back to “To eliminate vertical bars [Clock].” (Clock → Phase → Position)

## 5 Adjust the signal output range.

- **To adjust color gradation automatically [Range Adjustment]**

Every color gradation (0 to 255) can be displayed by adjusting the signal output level.

- (1) Display Pattern 2 in full screen on the monitor using the “Screen adjustment pattern files”.

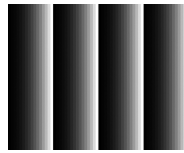

- (2) Choose <Range Adjustment> from the <Screen> menu, and press .
- (3) Press  while the message is displayed.  
The output range is adjusted automatically.
- (4) Close Pattern 2.

### Attention

- Smoothing setting may not be required depending on the display resolution. (You cannot choose the smoothing icon.)

## 6 Change the smoothing setting.

- **To modify blurred characters/lines [Smoothing]**

When a low-resolution image is displayed, the characters or lines of the displayed image may be blurred.

- (1) Choose <Screen> from the Adjustment menu, and press .
  - (2) Choose <Smoothing> from the <Screen> menu, and press .
  - (3) Select a suitable level from 1 to 5 (where 1 = soft and 5 = sharp) with  or , and press .
- The smoothing adjustment is completed.

## 2-3 Color Adjustment

### Simple adjustment [FineContrast mode]

This function allows you to select the best display mode for monitor brightness, etc.

- **FineContrast Mode**

An appropriate display mode is selectable out of five modes.

Mode	Purpose
Custom	Available for making desired setting.
sRGB	Suitable for color matching with sRGB compatible peripherals.
Text	Suitable for displaying texts for word processing or spreadsheets.
Picture	Suitable for displaying images such as photos or picture images.
Movie	Suitable for playing back animated images.

**FineContrast mode name**

Example: Custom

**Custom** — Displays current mode.

- **To select FineContrast mode name**

- (1) Press **[M]**.  
The FineContrast menu appears at the lower left of the screen.
- (2) One of five modes is displayed in turn each time **[M]** is pressed.
- (3) Press **[O]** to quit the operation.

**NOTE**

- The Adjustment menu and the FineContrast mode name cannot be displayed at the same time.
- This menu ends automatically when 2 seconds pass after the **[M]** button is pressed.

## Advanced Adjustments [Adjustment menu]

Independent setting and saving of color adjustment are available for each FineContrast mode.

### • To select an appropriate mode for images

√: Adjustment/setting available    -: Factory setting

Icon	Function	FineContrast mode				
		Custom	sRGB	Text	Picture	Movie
	Brightness	√	√	√	√	√
	Temperature	√	-	√	√	√
	Gamma	√	-	√	-	-
	Saturation	√	-	√	√	√
	Hue	√	-	√	√	√
	Gain	√	-	-	-	-
	Reset	√	-	√	√	√



Menu	Description	Adjustment range
Brightness 	To adjust the full screen brightness as desired	0 to 100%
	<b>NOTE</b> <ul style="list-style-type: none"> <li>You can also adjust the brightness by pressing  or  button while the adjustment menu is not displayed.</li> <li>Press  after adjustment.</li> <li>The values shown in the “%” are available only as reference.</li> </ul>	
Temperature 	To select a color temperature	4000K to 10000K in units of 500K (including 9300K).
	<b>NOTE</b> <ul style="list-style-type: none"> <li>Setting the value to “Off” presents the natural color temperature of the panel.</li> <li>The values shown in the Kelvin (K) are available only as reference.</li> </ul>	
Gamma 	To set a gamma value	1.8/2.0/2.2
	<b>NOTE</b> <ul style="list-style-type: none"> <li>Digital signal input is recommended for gamma value setting.</li> </ul>	
Saturation 	To adjust color saturation	-128 to 127 Setting the minimum (-128) turns the image to a monochrome screen.
	<b>Attention</b> <ul style="list-style-type: none"> <li>This function does not enable to display every color gradation.</li> </ul>	
Hue 	To change the flesh color, etc.	-32 to 32
	<b>Attention</b> <ul style="list-style-type: none"> <li>This function does not enable to display every color gradation.</li> </ul>	

### Attention







- Perform [Range Adjustment] before starting color adjustment for analog input signals.  
Refer to “To adjust color gradation automatically” on page 11.
- The FineContrast mode cannot be changed during color adjustment. Set the FineContrast mode in advance with .
- Wait 20 minutes or more from monitor power on before starting the color adjustment.
- Choose [Reset] from the Color menu to revert to the default setting (factory setting) of the color tone of the FineContrast mode selected.
- The same image may be seen in different colors on multiple monitors due to their monitor-specific characteristics. Make fine color adjustment visually when matching colors on multiple monitors.

### NOTE

- The Adjustment menu and the FineContrast mode name cannot be displayed at the same time.
- Adjustable functions vary depending on the type of FineContrast mode.

Menu	Description	Adjustment range
Gain 	To adjust red, green, and blue to a desired color tone respectively	0 to 100% Adjust the respective brightness of red/green/blue to make a desired color tone. Display an image with white or gray background for adjustment.
	<b>NOTE</b> <ul style="list-style-type: none"> <li>The values shown in the “%” are available only as reference.</li> <li>When using the &lt;Gain&gt; setting, the &lt;Temperature&gt; setting is set to “Off.”</li> </ul>	
Reset 	To reset the color settings of the selected FineContrast mode to the default settings.	

### • To set/adjust color

- Choose <Color> from the Adjustment menu, and press .
- Select a desired function from the <Color> menu, and press .  
The selected function menu appears.
- Adjust the selected item with , , , , and press .  
The adjustment is completed.

## 2-4 Off Timer Settings

### • To set monitor power-off time [Off Timer]

This function allows the monitor to automatically turn off after a specified time has passed. This function serves to reduce afterimages caused when the monitor screen is left on for a long time period without use. Use this function when an image is displayed throughout the day.

#### Attention







- The Off Timer functions even in the power saving mode, but the advance notice is disabled. The monitor power is turned off without advance notice.

#### [Off Timer System]

Timer	Monitor	Power Indicator
ON time (1H - 23H)	Operating	Blue
Last 15 min. in “ON time”	Advance Notice*1	Flashing blue
“ON time” expired	Power Off	Off

\*1 When  is pressed during the advance notice period, the monitor continues to operate for additional 90 minutes. Extension of operation time can be set without limitation.

#### [Procedure]

- Choose <Others> from the Adjustment menu, and press .
- Choose <Off Timer> from the <Others> menu, and press .  
The <Off Timer> menu appears.
- Select “Enable” with  or .
- Set a monitor ON time (1 to 23 hours) with  or , and press .  
The Off Timer setting is completed.

#### [Resumption Procedure]

Press .

## 2-5 Screen Size Selection

### • To change screen size [Screen Size]

This function allows you to change the screen size when a low-resolution image is displayed.

Menu	Function
Full (default setting)	Displays an image in full screen. Images are distorted in some cases because the vertical rate is not equal to the horizontal rate.
Enlarged	Displays an image in full screen. In some cases, a blank horizontal or vertical border appears to equalize the vertical rate and the horizontal rate.
Normal	Displays images with the specified resolution.

Example: Image size 1280 × 1024

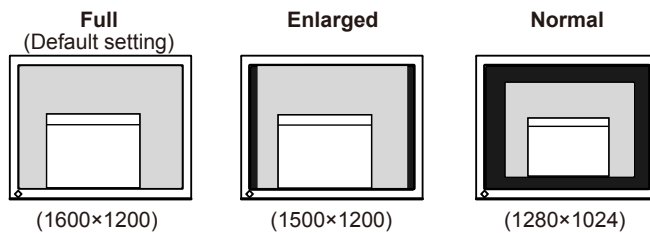

### [Procedure]

- (1) Choose <Others> from the Adjustment menu, and press .
- (2) Choose <Screen Size> from the <Others> menu, and press .
- The screen size setting window appears.
- (3) Select “Full,” “Enlarged,” or “Normal” with  or , and press .
- The screen size setting is completed.

### • To adjust brightness of non-display area [Border Intensity]

A border (black area with no image) around the image appears in the “Normal” or “Enlarged” mode.

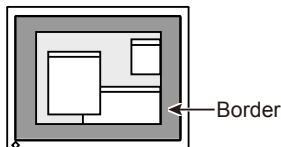





- (1) Choose <Others> from the Adjustment menu, and press .
- (2) Choose <Border Intensity> from the <Others> menu, and press .
- The <Border Intensity> menu appears.
- (3) Adjust border intensity with  or , and press .
- The border intensity adjustment is completed.

## 2-6 Power Indicator/EIZO Logo Display Setting

### • To turn off the Power indicator while a screen is displayed [Power Indicator]



This function enables to turn off the Power indicator (blue) while a screen is displayed.

- (1) Choose <Others> from the Adjustment menu, and press .
- (2) Choose <Power Indicator> from the <Others> menu, and press .  
The <Power Indicator> menu appears.
- (3) Select “Disable” with  or , and press .  
The Power Indicator setting is completed.



### • To display EIZO logo [EIZO Logo Appearing Function]

When this unit is turned on, the EIZO logo appears at the center of the screen. Selection to display or not to display the logo is available with this function.

#### [Procedure]

- (1) Press  to power off the unit.
- (2) Press  again while pressing .  
The EIZO logo does not appear on the screen.







#### [Resetting]

- (1) Press  to power off the unit.
- (2) Press  again while pressing .  
The logo appears again.



## 2-7 Locking Buttons

### • To lock operation [Adjustment Lock]



This function locks the buttons to retain the status adjusted or set once.

Buttons that can be locked	<ul style="list-style-type: none"> <li>•  (Enter button) Adjustments/settings using Adjustment menu</li> <li>•  (Auto adjustment button)</li> </ul>
Buttons that cannot be locked	<ul style="list-style-type: none"> <li>•  (Power button)</li> <li>•  (Input signal selection button)</li> <li>•  (Mode button) FineContrast mode name selection</li> <li>•  /  (Control buttons) Brightness adjustment</li> </ul>

#### [Procedure]

- (1) Press  to turn off the unit.
- (2) Press  again while pressing .  
The screen is displayed with the adjustment lock.

#### [Unlocking]

- (1) Press  to turn off the unit.
- (2) Press  again while pressing .  
The screen is displayed with the adjustment lock released.

#### NOTE

- The logo appears with the default setting.



## 2-8 Setting Adjustment menu Display

- To update menu settings [Menu Size/Menu Position/Menu Off Timer/Translucent/Orientation]

### Menu Size

Change the Adjustment menu size using the following procedure.

- (1) Choose <Others> from the Adjustment menu, and press .
- (2) Choose <Menu Settings> from the <Others> menu, and press .
- (3) Choose <Menu Size> from the <Menu Settings> menu, and press   
The <Menu Size> menu appears.
- (4) Select “Enlarged” using  or , and press .

The menu size setting is completed.

### Menu Position

Adjust the menu position using the following procedure.

- (1) Choose <Others> from the Adjustment menu, and press .
- (2) Choose <Menu Settings> from the <Others> menu, and press .
- (3) Choose <Menu Position> from the <Menu Settings> menu, and press   
The <Menu Position> menu appears.
- (4) Select a menu position with , , , or , and press .

The menu position setting is completed.

### Menu Off Timer

Set the menu display time using the following procedure.

- (1) Choose <Others> from the Adjustment menu, and press .
- (2) Choose <Menu Settings> from the <Others> menu, and press .
- (3) Choose <Menu Off Timer> from the <Menu Settings> menu, and press   
The <Menu Off Timer> menu appears.
- (4) Choose “Enable” with  or .
- (5) Choose an Off Time (15/30/45/60 seconds) with  or , and press .

The menu off timer setting is completed.

### Translucent

Set the transparency for menu display using the following procedure.

- (1) Choose <Others> from the Adjustment menu, and press .
- (2) Choose <Menu Settings> from the <Others> menu, and press .
- (3) Choose <Translucent> from the <Menu Settings> menu, and press   
The <Translucent> menu appears.
- (4) Adjust the transparency for menu display with  or , and press .

The transparency setting is completed.

### Orientation

The orientation of the Adjustment menu can be turned 90 degrees.

- (1) Choose <Others> from the Adjustment menu, and press .
- (2) Choose <Orientation> from the <Others> menu, and press   
The <Orientation> menu appears.
- (3) Select “Landscape” or “Portrait” with  or , and press .

The orientation setting is completed.

#### NOTE

- The display time of the FineContrast mode name remains unchanged.

## 2-9 Viewing Information/Setting Language

### • To check settings, usage time, etc. [Information]

This function allows you to check settings, model name, serial number, and usage time of the monitor.

- (1) Choose <Information> from the Adjustment menu, and press .
- (2) Then, press  to check settings, etc.

### • To set a language to be displayed [Language]

Select the Adjustment menu language.

#### Selectable languages

English/German/French/Spanish/Italian/Swedish/Japanese

- (1) Choose <Language> menu from the Adjustment menu, and press .
- (2) Select a language with <▼>, <▶>, and press .

#### NOTE

- The usage time is not always “0” when you purchase the monitor due to factory inspection.

## 2-10 Setting BrightRegulator

### • To set automatic brightness adjustment [BrightRegulator]

The sensor on the front side of the monitor detects the environmental brightness to adjust the screen brightness automatically and comfortably.

- (1) Choose <Others> from the Adjustment menu, and press .
- (2) Choose <BrightRegulator> from the <Others> menu, and press .
- (3) Select “Enable” or “Disable” with  or , and press .

#### NOTE

- Be careful not to block the sensor on the lower side of the monitor when using the BrightRegulator function.

## 2-11 Resumption of Default Setting

### • To reset color adjustment [Reset]

Resume the default settings (factory settings) for color adjustment.

- (1) Choose <Color> from the Adjustment menu, and press .
- (2) Choose <Reset> from the <Color> menu, and press .
- (3) Select <Reset> with  or , and press .

#### NOTE

- For default settings, refer to “Main default settings (factory settings)” on page 26.

### • To reset all settings [Reset]

Reset all adjustments/settings to the factory default settings.

- (1) Choose <Others> from the Adjustment menu, and press .
- (2) Choose <Reset> from the <Others> menu, and press .
- (3) Select <Reset> with  or , and press .

# Chapter 3 Connecting Cables

## 3-1 Connecting Two PCs to the Monitor

Two PCs can be connected to the monitor through the DVI-I and the D-Sub mini 15 pin connector on the back of the monitor.

### Connection examples

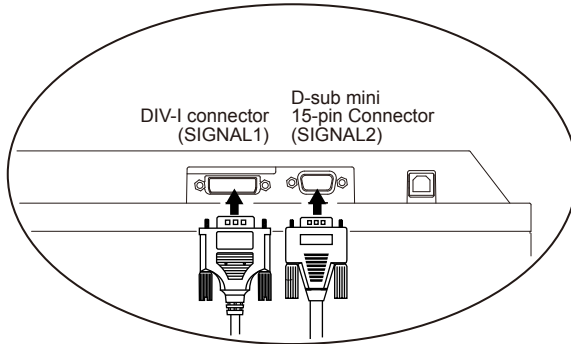

#### Attention

- When using an optional signal cable (FD-C16), be sure to connect the D-sub mini 15-pin connector to the PC, and the DVI-I connector to the monitor. Wrong connection may result in no picture display.

		PC 1		PC 2		
Example 1	Digital	DVI	Signal cable (supplied with FD-C39)	Signal cable (supplied MD-C87)	D-sub mini 15-pin	Analog
Example 2	Analog	D-sub mini 15-pin	Signal cable (FD-C16 option)	Signal cable (supplied MD-C87)	D-sub mini 15-pin	Analog

### Selecting input signal

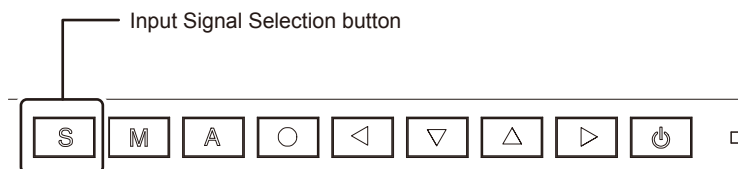

Switch the input signal with **[S]**. Input signal switches each time **[S]** is pressed. When the signal is switched, the active signal type (Analog or Digital) appears at the top right corner of the screen for two seconds.

- **To set auto-switching of input signals [Input Signal]**

The monitor recognizes the connector through which PC signals are input. When either PC is turned off or enters the power-saving mode, the monitor automatically displays signals of another PC.

Priority setting	Function
Auto	When either PC is turned off or enters the power-saving mode, the monitor automatically displays signals of another PC.
Manual	The monitor does not detect the PC's signals automatically. Select an active input signal with <b>[S]</b> .

**[Input signal setting]**

- (1) Choose <Others> from the Adjustment menu, and press **[O]**.
- (2) Choose <Input Signal> from the <Others> menu, and press **[O]**.  
The <Input Signal> menu appears.
- (3) Select "Auto" or "Manual" with **[Δ]** or **[▽]**, and press **[O]**.  
The Input Priority setting is completed.

### 3-2 Connecting Peripheral USB Devices

This monitor has a hub compatible with USB. Connected to a PC compatible with USB or another USB hub, this monitor functions as a USB hub allowing connection to peripheral USB devices.

- **Required System Environment**
  - (1) A PC equipped with a USB port or another USB hub connected to a USB compatible PC
  - (2) Windows 98/Me/2000/XP/Vista/7/8 or Mac OS 8.5.1 or later
  - (3) EIZO USB cable (MD-C93)
- **Connection Procedure (Setup of USB Function)**
  - (1) Connect the monitor first to a PC using the signal cable, and run the PC.
  - (2) Connect the supplied USB cable between the downstream USB port of a USB compatible PC (or another USB hub) and the monitor's upstream USB port.
  - (3) When the USB function setup is completed, the monitor functions as a USB hub allowing connection to various peripheral USB devices through its downstream USB ports.

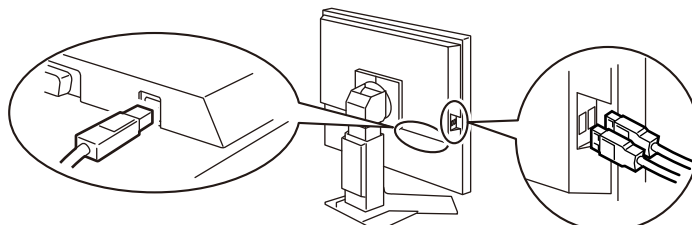

The USB function is set up automatically upon connection of the USB cable.





**Attention**

- This monitor may not work depending on PC, OS or peripheral devices to be used.  
For USB compatibility of peripheral devices, contact their manufactures.
- If the monitor is in the power saving mode, or if the monitor is connected to the power outlet with the monitor turned off, all the devices connected to the USB ports (upstream and downstream) work. Therefore, power consumption of the monitor varies with connected devices even in the power saving mode.

# Chapter 4 Troubleshooting

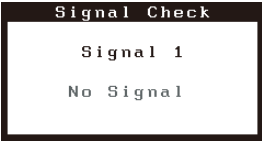
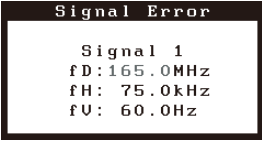
If a problem still remains after applying the suggested remedies, contact your local dealer.

- No-picture problems → See No.1 - No.2.
- Imaging problems → See No.3 - No.11.
- Other problems → See No.12 - No.17.

Problems	Possible cause and remedy
<b>1. No picture</b> <ul style="list-style-type: none"> <li>• Power indicator does not light.</li> </ul>	<ul style="list-style-type: none"> <li>• Check whether the power cord is connected correctly.</li> </ul>
<ul style="list-style-type: none"> <li>• Power indicator is lighting blue.</li> <li>• Power indicator is lighting yellow.</li> </ul>	<ul style="list-style-type: none"> <li>• Check gain setting.</li> <li>• Turn on the PC.</li> <li>• Switch the input signal with [S].</li> <li>• Operate the mouse or keyboard.</li> </ul>
<b>2. The message below appears.</b> <ul style="list-style-type: none"> <li>• This message appears when no signal is input.</li> </ul>  <p>Signal Check Signal 1 No Signal</p>	<p>This message appears when the signal is not input correctly even when the monitor functions properly.</p> <ul style="list-style-type: none"> <li>• The message shown left may appear, because some PCs do not output the signal soon after power-on.</li> <li>• Check whether the PC is turned on.</li> <li>• Check whether the signal cable is connected properly.</li> <li>• Switch the input signal with [S].</li> </ul>
<ul style="list-style-type: none"> <li>• The message below shows that the input signal is out of the specified frequency range. (Such signal frequency is displayed in red.) Example:</li> </ul>  <p>Signal Error Signal 1 fD: 165.0MHz fH: 75.0kHz fV: 60.0Hz</p>	<ul style="list-style-type: none"> <li>• Select an appropriate display mode using the graphics board's utility software. Refer to the manual of the graphics board for details.</li> </ul>
<b>3. Display position is incorrect.</b> 	<ul style="list-style-type: none"> <li>• Adjust image position so that it is displayed properly within the display area using the &lt;Position&gt; adjustment.</li> <li>• If the problem persists, use the graphics board's utility software if available to change the display position.</li> </ul>
<b>4. Vertical bars appear on the screen or a part of the image is flickering.</b> 	<ul style="list-style-type: none"> <li>• Adjust using &lt;Clock&gt; from &lt;Screen&gt; menu at the Adjustment menu.</li> </ul>
<b>5. Whole screen is flickering or blurring.</b> 	<ul style="list-style-type: none"> <li>• Adjust using &lt;Phase&gt;.</li> </ul>
<b>6. Characters are blurred.</b>	<ul style="list-style-type: none"> <li>• Adjust using &lt;Smoothing&gt;.</li> </ul>
<b>7. Upper part of the screen is distorted as shown below.</b> 	<ul style="list-style-type: none"> <li>• This is caused when both composite sync (X-OR) signal and separate vertical sync signal are input simultaneously. Select either composite signal or separate signal.</li> </ul>
<b>8. The screen is too bright or too dark.</b>	<ul style="list-style-type: none"> <li>• Adjust &lt;Brightness&gt;. (The LCD monitor backlight has a fixed life span. When the screen becomes dark or begins to flicker, contact your local dealer.)</li> </ul>

Problems	Possible cause and remedy
9. Afterimages appear.	<ul style="list-style-type: none"> <li>• Use a screen saver or off timer function for a long-time image display.</li> <li>• Afterimages are particular to LCD monitors. Avoid displaying the same image for a long time.</li> </ul>
10. Green/red/blue/white dots or defective dots remain on the screen.	<ul style="list-style-type: none"> <li>• This is due to LCD panel characteristics and is not a failure.</li> </ul>
11. Interference patterns or fingerprints remain on the screen.	<ul style="list-style-type: none"> <li>• Leave the monitor with a white or black screen. The symptom may disappear.</li> </ul>
12. Noise appears on the screen.	<ul style="list-style-type: none"> <li>• When entering the signals of analog input, select 1 to 4 in &lt;Signal Filter&gt; from the &lt;Screen&gt; menu to change the mode.</li> </ul>
13. The <Smoothing> icon on the Adjustment menu <Screen> cannot be selected.	<ul style="list-style-type: none"> <li>• &lt;Smoothing&gt; is disabled with a resolution of 1600 × 1200 or 800 × 600</li> <li>• &lt;Smoothing&gt; cannot be selected when the resolution is doubled with &lt;Screen Size&gt; menu. (Example: 640 × 480 is enlarged to 1280 × 960)</li> </ul>
14. The Main menu of Adjustment menu does not start.	<ul style="list-style-type: none"> <li>• Check for Adjustment Lock function.</li> </ul>
15. The <b>A</b> button does not function.	<ul style="list-style-type: none"> <li>• The <b>A</b> button does not function when digital signal is input.</li> <li>• Check whether the buttons are lockd.</li> <li>• This function works correctly when an image is fully displayed over the Windows or Macintosh display area. It does not work properly when an image is displayed only on a part of the screen (DOS prompt window, for example) or when a black background (wallpaper, etc.) is in use. This function does not work correctly with some graphics boards.</li> </ul>
16. USB function cannot be set up.	<ul style="list-style-type: none"> <li>• Check whether the USB cable is connected correctly.</li> <li>• Check whether the PC and OS are USB compliant. (For USB compliance of the respective devices, consult their manufacturers.)</li> <li>• Check the PC's BIOS setting for USB when using Windows 98/Me/2000/XP/Vista/7/8. Refer to the manual of the PC for details.)</li> </ul>
17. The PC does not work/USB devices connected to the monitor do not work.	<ul style="list-style-type: none"> <li>• Check whether the USB cable is connected correctly.</li> <li>• Change the cable connection to another USB port. If the PC works normally with this port change, contact your local dealer. (Refer to the manual of the PC for details.) <ul style="list-style-type: none"> <li>• Try the following:</li> <li>• Reboot the PC.</li> </ul> </li> </ul> <p>Connect the PC directly to the peripheral devices. When the devices work normally without being connected to the monitor (USB hub), contact your local dealer.</p>

# Chapter 5 Reference

## 5-1 Attaching an Arm

The stand can be removed and replaced with an arm (or another stand) to be attached to the monitor. Use an arm or stand of EIZO option.

### [Attaching]

**1** Lay the LCD monitor on a soft cloth spread over on a stable surface with the panel surface facing down.

**2** Remove the stand. (Prepare a screwdriver.)

Unscrew the four screws securing the unit and the stand with the screwdriver.

**3** Attach the monitor to the arm or stand.

Secure the monitor to the arm or stand using the screws specified in the user's manual of the arm or stand.

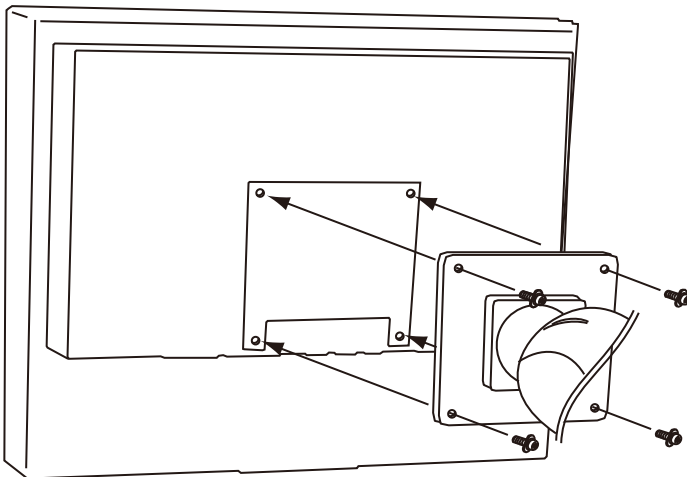

### Attention

- When attaching an arm or stand, follow the instructions of their user's manual.
- When using another manufacturer's arm or stand, confirm the following in advance and select one conforming to the VESA standard. Use the M4 × 12 screws supplied with this monitor.
  - Clearance between the screw holes: 100 mm × 100 mm
  - Thickness of plate: 2.6 mm
  - Strong enough to support weight of the monitor unit (except the stand) and attachments such as cables.
- Attach an arm or stand to meet the following tilt angles of the monitor.
  - Up 45 degrees, down 45 degrees
  - Up 45 degrees, down 45 degrees (vertical display, 90 degrees clockwise)
- Connect the cables after attaching an arm.

## 5-2 Power Saving Mode

### ■ Analog input

This monitor complies with the VESA DPMS standard.

#### [Power Saving System]

PC		Monitor	Power Indicator
Operating		Operating	Blue
Power saving	STAND-BY SUSPENDED OFF	Power saving	Yellow

#### [Resumption Procedure]

- Operate the mouse or keyboard to resume the normal screen.

### ■ Digital input

This monitor complies with the DVI DMPM standard.

#### [Power Saving System]

The monitor enters the power saving mode in five seconds in connection with the PC setting.

PC		Monitor	Power Indicator
Operating		Operating	Blue
Power saving		Power saving	Yellow

#### [Resumption Procedure]

- Operate the mouse or keyboard to resume the normal screen.

## 5-3 Cleaning

If necessary, the stains on the cabinet and panel surface can be removed by moistening part of a soft cloth with water.

#### Attention

- Chemicals such as alcohol and antiseptic solution may cause gloss variation, tarnishing, and fading of the cabinet or panel, and also quality deterioration of the image.
- Never use any thinner, benzene, wax, and abrasive cleaner, which may damage the cabinet or panel.

#### NOTE

- The optional ScreenCleaner is recommended for cleaning the cabinet and panel surface.



## 5-4 Specifications

LCD Panel	21.3-inch (540 mm) TFT color LCD with anti-glare hard coating Viewing angle: Vertical 178°, Horizontal 178° (CR: 10 or more)	
Dot Pitch	0.270 mm	
Horizontal Scan Frequency	Analog: 24 - 80 kHz Digital: 31 - 76 kHz	
Vertical Scan Frequency	Analog: 49 - 76 Hz (Non-interlace) (1600 × 1200: 49 - 61 Hz) Digital: 59 - 61 Hz (Non-interlace) (VGA TEXT: 69 - 71 Hz)	
Resolution	1600 dots × 1200 lines	
Max. Dot Clock	Analog: 162 MHz Digital: 162 MHz	
Max. Display Colors	16.77 million colors	
Display Area (H × V)	432 mm × 324 mm	
Power Supply	100 - 120 VAC ±10% 50/60 Hz, 0.7 A 200 - 240 VAC ±10% 50 Hz, 0.4 A	
Power Consumption	Max.:70 W (USB device connected) Power saving mode: 2 W or less (for single signal input with no USB device connected) Power switch Off: 1 W or less	
Input Signal Connectors	DVI-I connector, D-sub mini 15-pin connector	
Analog Input Signal (Sync)	a)	Separate, TTL, positive/negative
	b)	Composite, TTL, positive/negative
Analog Input Signal (Video)	Analog, positive (0.7 Vp-p/75 Ω)	
Digital Signal Transmission System	TMDS (Single Link)	
Video Signal Memory	Analog signal: 45 (preset: 22)	
	Digital Signal: 10 (preset: 0)	
Plug & Play	VESA DDC 2B	
Dimensions (Main unit)	465 mm (W) × 453 - 535 mm (H) × 208.5 mm (D) (18.3" (W) × 17.8"-21.1" (H) × 8.2" (D))	
Dimensions (without stand)	465 mm (W) × 361 mm (H) × 64 mm (D) (18.3" (W) × 14.2" (H) × 2.52" (D))	
Mass (Main unit)	9.7 kg (21.4 lbs)	
Mass (without stand)	6.7 kg (14.8 lbs)	
Environmental Conditions	Operating temperature: 0 °C - 35 °C Storage temperature: -20 °C - 60 °C Relative humidity: 30% - 80% (no condensation)	
USB	Standard	Rev. 2.0 compliant
	Port	Upstream port × 1, Downstream port × 2
	Transmission rate	480 Mbps (High speed) 12 Mbps (Full speed) 1.5 Mbps (Low speed)
	Supply current	Downstream: Max. 500 mA/1 port

## Main default settings (factory settings)

BrightRegulator		Enable
Smoothing		3
FineContrast Mode		Custom
Screen Size		Full
Input Signal		Manual
Off Timer		Disabled
Menu Settings	Menu Size	Normal
	Menu Off Timer	45 seconds
Language		English

## Outside Dimensions

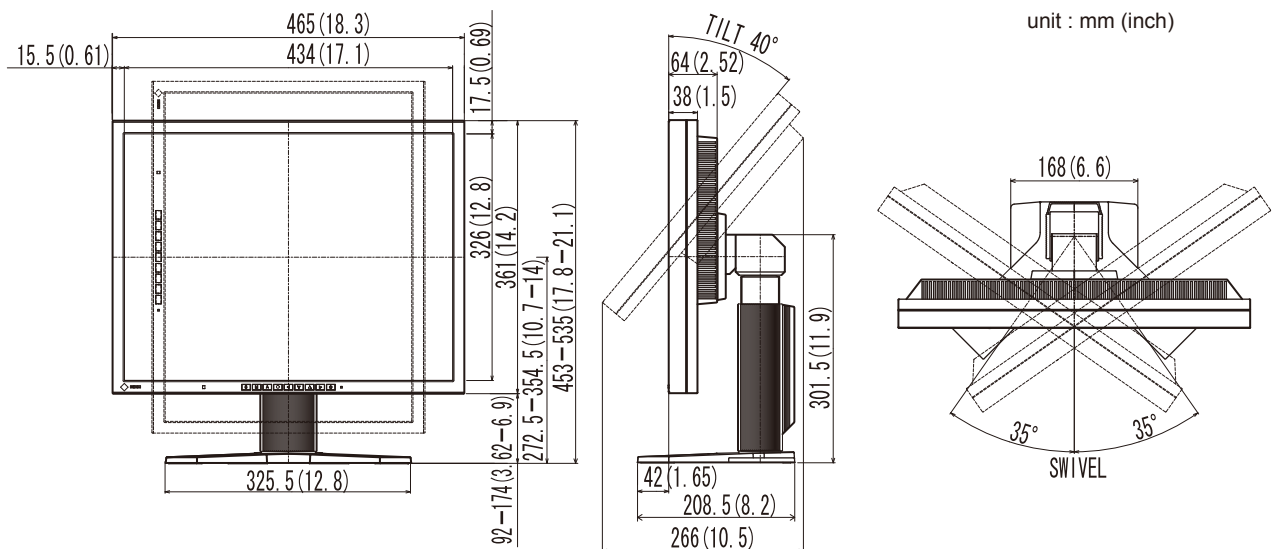

## Connector Pin Assignment

- DVI-I connector

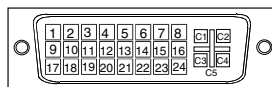

Pin No.	Signal	Pin No.	Signal	Pin No.	Signal
1	TMDS Data 2-	11	TMDS Data1/3 Shield	21	NC*
2	TMDS Data 2+	12	NC*	22	TMDS Clock shield
3	TMDS Data2/4 Shield	13	NC*	23	TMDS Clock+
4	NC*	14	+5V Power	24	TMDS Clock-
5	NC*	15	Ground (return for +5V, Hsync and Vsync)	C1	Analog Red
6	DDC Clock (SCL)	16	Hot Plug Detect	C2	Analog Green
7	DDC Data (SDA)	17	TMDS Data0-	C3	Analog Blue
8	Analog Vertical Sync	18	TMDS Data0+	C4	Analog Horizontal Sync
9	TMDS Data1-	19	TMDS Data0/5 Shield	C5	Analog Ground (analog R,G,&B return)
10	TMDS Data1+	20	NC*		

(NC\*: No Connection)

- D-sub mini 15-pin connector

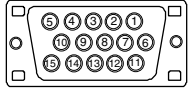

Pin No.	Signal	Pin No.	Signal	Pin No.	Signal
1	Red	6	Red ground	11	(Short-circuited to pin 10)
2	Green	7	Green ground	12	Data (SDA)
3	Blue	8	Blue ground	13	H. Sync
4	Ground	9	NC	14	V. Sync
5	NC	10	Ground	15	Clock (SCL)

- USB port

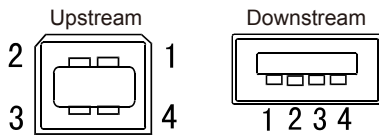

Contact No.	Signal	Remarks
1	VCC	Cable power
2	- Data	Serial data
3	+ Data	Serial data
4	Ground	Cable ground

#### Option List

Cleaning Kit	EIZO ScreenCleaner
--------------	--------------------

## 5-5 Glossary

### Clock

The analog input monitor needs to reproduce a clock of the same frequency as the dot clock of the graphics system in use, when the analog input signal is converted to a digital signal for image display.

This is called clock adjustment. If the clock pulse is not set correctly, some vertical bars appear on the screen.

### DVI (Digital Visual Interface)

DVI is a digital interface standard. DVI allows direct transmission of the PC's digital data without loss.

This adopts the TMDS transmission system and DVI connectors. There are two types of DVI connectors. One is a DVI-D connector for digital signal input only. The other is a DVI-I connector for both digital and analog signal inputs.

### DVI DMPM (DVI Digital Monitor Power Management)

DVI DMPM is a digital interface power-saving function. The "Monitor ON (operating mode)" and "Active Off (power-saving mode)" are indispensable for DVI DMPM as the monitor's power mode.

### Gain

This is used to adjust each color parameter for red, green and blue. An LCD monitor displays the color by the light passing through the panel color filter. Red, green and blue are the three primary colors. All the colors on the screen are displayed by combining these three colors. The color tone can be changed by adjusting the light intensity (volume) passing through each color's filter.

**Gamma**

Generally, the monitor brightness varies nonlinearly with the input signal level, which is called “Gamma Characteristic”. A small gamma value produces a low-contrast image, while a large gamma value produces a high-contrast image.

**Phase**

Phase means the sampling timing to convert the analog input signal to a digital signal. Phase adjustment is made to adjust the timing. It is recommended that phase adjustment be made after the clock is adjusted correctly.

**Range Adjustment**

Range adjustment controls the signal output levels to display every color gradation. It is recommended that range adjustment be made before color adjustment.

**Resolution**

The LCD panel consists of numerous pixels of specified size, which are illuminated to form images. This monitor consists of 1600 horizontal pixels and 1200 vertical pixels. At a resolution of  $1600 \times 1200$ , all pixels are illuminated as a full screen (1:1).

**sRGB (Standard RGB)**

International standard for “color reproduction and color space” among peripheral devices (such as monitors, printers, digital cameras, scanners). sRGB allows Internet users to closely match colors as a simple color matching means for the Internet use.

**Temperature**

Color temperature is a method to measure the white color tone, generally indicated in degrees Kelvin. The screen becomes reddish at a low temperature, and bluish at a high temperature, like the flame temperature.

5000K: Slightly reddish white

6500K: Warm white like paper white

9300K: Slightly bluish white

**TMD5 (Transition Minimized Differential Signaling)**

A signal transmission system for digital interface.

**VESA DPMS (Video Electronics Standards Association - Display Power Management Signaling)**

VESA provides the standardization of signals from PC (graphics board) for power saving of PC monitors. DPMS defines the signal status between PC and monitor.

## 5-6 Preset Timing

The following table shows factory preset video timing (for analog signal only).

Mode	Dot clock		Frequency	Polarity
			Horizontal: kHz Vertical: Hz	
VGA 640×480@60Hz	25.2 MHz	Horizontal	31.47	Negative
		Vertical	59.94	Negative
VGA 720×400@70Hz	28.3 MHz	Horizontal	31.47	Negative
		Vertical	70.09	Positive
Macintosh 640×480@67Hz	30.2 MHz	Horizontal	35.00	Negative
		Vertical	66.67	Negative
Macintosh 832×624@75Hz	57.3 MHz	Horizontal	49.73	Negative
		Vertical	74.55	Negative
Macintosh 1152×870@75Hz	100.0 MHz	Horizontal	68.68	Negative
		Vertical	75.06	Negative
Macintosh 1280×960@75Hz	126.2 MHz	Horizontal	74.76	Positive
		Vertical	74.76	Positive
PC-9801 640×400@56Hz	21.0MHz	Horizontal	24.83	Negative
		Vertical	56.42	Negative
PC-9821 640×400@70Hz	25.2 MHz	Horizontal	31.50	Negative
		Vertical	70.15	Negative
VESA 640×480@72Hz	31.5 MHz	Horizontal	37.86	Negative
		Vertical	72.81	Negative
VESA 640×480@75Hz	31.5 MHz	Horizontal	37.50	Negative
		Vertical	75.00	Negative
VESA 800×600@56Hz	36.0 MHz	Horizontal	35.16	Positive
		Vertical	56.25	Positive
VESA 800×600@60Hz	40.0 MHz	Horizontal	37.88	Positive
		Vertical	60.32	Positive
VESA 800×600@72Hz	50.0 MHz	Horizontal	48.08	Positive
		Vertical	72.19	Positive
VESA 800×600@75Hz	49.5 MHz	Horizontal	46.88	Positive
		Vertical	75.00	Positive
VESA 1024×768@60Hz	65.0 MHz	Horizontal	48.36	Negative
		Vertical	60.00	Negative
VESA 1024×768@70Hz	75.0 MHz	Horizontal	56.48	Negative
		Vertical	70.07	Negative
VESA 1024×768@75Hz	78.8 MHz	Horizontal	60.02	Positive
		Vertical	75.03	Positive
VESA 1152×864@75Hz	108.0 MHz	Horizontal	67.50	Positive
		Vertical	75.00	Positive
VESA 1280×960@60Hz	108.0 MHz	Horizontal	60.00	Positive
		Vertical	60.00	Positive
VESA 1280×1024@60Hz	108.0 MHz	Horizontal	63.98	Positive
		Vertical	60.02	Positive
VESA 1280×1024@75Hz	135.0 MHz	Horizontal	79.98	Positive
		Vertical	75.03	Positive
VESA 1600×1200@60Hz	162.0 MHz	Horizontal	75.00	Positive
		Vertical	60.00	Positive

### Attention

- Display position may be deviated depending on the PC connected, which may require screen adjustment using Adjustment menu.
- If a signal other than those listed in the table is input, adjust the screen using the Adjustment menu. However, screen display may still be incorrect even after the adjustment.
- When interlace signals are used, the screen cannot be displayed correctly even after screen adjustment using the Adjustment menu.

For U.S.A. , Canada, etc. (rated 100-120 Vac) Only

## FCC Declaration of Conformity

**We, the Responsible Party**

EIZO Inc.

5710 Warland Drive, Cypress, CA 90630

Phone: (562) 431-5011

**declare that the product**

Trade name: EIZO

Model: FlexScan S2100

**is in conformity with Part 15 of the FCC Rules. Operation of this product is subject to the following two conditions: (1) this device may not cause harmful interference, and (2) this device must accept any interference received, including interference that may cause undesired operation.**

This equipment has been tested and found to comply with the limits for a Class B digital device, pursuant to Part 15 of the FCC Rules. These limits are designed to provide reasonable protection against harmful interference in a residential installation. This equipment generates, uses, and can radiate radio frequency energy and, if not installed and used in accordance with the instructions, may cause harmful interference to radio communications. However, there is no guarantee that interference will not occur in a particular installation. If this equipment does cause harmful interference to radio or television reception, which can be determined by turning the equipment off and on, the user is encouraged to try to correct the interference by one or more of the following measures.

- \* Reorient or relocate the receiving antenna.
- \* Increase the separation between the equipment and receiver.
- \* Connect the equipment into an outlet on a circuit different from that to which the receiver is connected.
- \* Consult the dealer or an experienced radio/TV technician for help.

Changes or modifications not expressly approved by the party responsible for compliance could void the user's authority to operate the equipment.

### Note

Use the attached specified cable below or EIZO signal cable with this monitor so as to keep interference within the limits of a Class B digital device.

- AC Cord
- Shielded Signal Cable (enclosed)

## Canadian Notice

This Class B digital apparatus complies with Canadian ICES-003.

Cet appareil numérique de la classe B est conforme à la norme NMB-003 du Canada.

### **Hinweise zur Auswahl des richtigen Schwenkarms für Ihren Monitor**

Dieser Monitor ist für Bildschirmarbeitsplätze vorgesehen. Wenn nicht der zum Standardzubehör gehörige Schwenkarm verwendet wird, muss statt dessen ein geeigneter anderer Schwenkarm installiert werden. Bei der Auswahl des Schwenkarms sind die nachstehenden Hinweise zu berücksichtigen:

Der Standfuß muß den nachfolgenden Anforderungen entsprechen:

- a) Der Standfuß muß eine ausreichende mechanische Stabilität zur Aufnahme des Gewichtes vom Bildschirmgerät und des spezifizierten Zubehörs besitzen. Das Gewicht des Bildschirmgerätes und des Zubehörs sind in der zugehörigen Bedienungsanleitung angegeben.
- b) Die Befestigung des Standfusses muß derart erfolgen, daß die oberste Zeile der Bildschirmanzeige nicht höher als die Augenhöhe eines Benutzers in sitzender Position ist.
- c) Im Fall eines stehenden Benutzers muß die Befestigung des Bildschirmgerätes derart erfolgen, daß die Höhe der Bildschirmmitte über dem Boden zwischen 135 – 150 cm beträgt.
- d) Der Standfuß muß die Möglichkeit zur Neigung des Bildschirmgerätes besitzen (max. vorwärts: 5°, min. nach hinten  $\geq 5^\circ$ ).
- e) Der Standfuß muß die Möglichkeit zur Drehung des Bildschirmgerätes besitzen (max.  $\pm 180^\circ$ ). Der maximale Kraftaufwand dafür muß weniger als 100 N betragen.
- f) Der Standfuß muß in der Stellung verharren, in die er manuell bewegt wurde.
- g) Der Glanzgrad des Standfusses muß weniger als 20 Glanzeinheiten betragen (seidenmatt).
- h) Der Standfuß mit Bildschirmgerät muß bei einer Neigung von bis zu 10° aus der normalen aufrechten Position kippstabil sein.

### **Hinweis zur Ergonomie :**

Dieser Monitor erfüllt die Anforderungen an die Ergonomie nach EK1-ITB2000 mit dem Videosignal, 1600 × 1200 RGB analog, 0,7 Vp-p und mindestens 60,0 Hz Bildwiederholfrequenz, non interlaced. Weiterhin wird aus ergonomischen Gründen empfohlen, die Grundfarbe Blau nicht auf dunklem Untergrund zu verwenden (schlechte Erkennbarkeit, Augenbelastung bei zu geringem Zeichenkontrast.)

„Maschinenlärminformations-Verordnung 3. GPSGV:

Der höchste Schalldruckpegel beträgt 70 dB(A) oder weniger gemäss EN ISO 7779“

## 关于电子信息产品污染控制标识



本标识根据「电子信息产品污染控制管理办法」，适用于在中华人民共和国销售的电子信息产品。标识中央的数字为环保使用期限的年数。只要您遵守该产品相关的安全及使用注意事项，在自制造日起算的年限内，不会产生对环境污染或人体及财产的影响。上述标识粘贴在机器背面。

### • 有毒有害物质或元素的名称及含量

部件名称	有毒有害物质或元素					
	铅 (Pb)	汞 (Hg)	镉 (Cd)	六价铬 (Cr (VI))	多溴联苯 (PBB)	多溴二苯醚 (PBDE)
印刷电路板	×	○	○	○	○	○
机箱	○	○	○	○	○	○
液晶显示器	×	×	○	○	○	○
其他	×	○	○	○	○	○

○：表示该有毒有害物质在该部件所有均质材料中的含量均在 SJ/T 11363-2006 规定的限量要求以下。  
 ×：表示该有毒有害物质至少在该部件的某一均质材料中的含量超出 SJ/T 11363-2006 规定的限量要求。  
 （企业可在此处，根据实际情况对上表中打“×”的技术原因进行进一步说明）



