

Instructions for Use

RadiForce® GX550

Monochrome LCD Monitor

Important









Please read this “Instructions for Use”, and “Installation Manual” (separate volume) carefully to familiarize yourself with safe and effective usage.

Please retain this manual for future reference.

-
- For monitor adjustment and settings, refer to the “Installation Manual”.
 - For the latest product information including the “Instructions for Use”, refer to our web site :
<http://www.eizoglobal.com>
-

SAFETY SYMBOLS

This manual and this product use the safety symbols below. They denote critical information. Please read them carefully.

 <p>WARNING Failure to abide by the information in a WARNING may result in serious injury and can be life threatening.</p>	 <p>CAUTION Failure to abide by the information in a CAUTION may result in moderate injury and/or property or product damage.</p>
	<p>Indicates a warning or caution. For example,  indicates an “electrical shock” hazard.</p>
	<p>Indicates a prohibited action. For example,  means “Do not disassemble”.</p>
	<p>Indicates a mandatory action. For example,  means “Ground the unit”.</p>

This product has been adjusted specifically for use in the region to which it was originally shipped. If operated outside this region, the product may not perform as stated in the specifications.

No part of this manual may be reproduced, stored in a retrieval system, or transmitted, in any form or by any means, electronic, mechanical, or otherwise, without the prior written permission of EIZO Corporation. EIZO Corporation is under no obligation to hold any submitted material or information confidential unless prior arrangements are made pursuant to EIZO Corporation’s receipt of said information. Although every effort has been made to ensure that this manual provides up-to-date information, please note that EIZO monitor specifications are subject to change without notice.

PRECAUTIONS







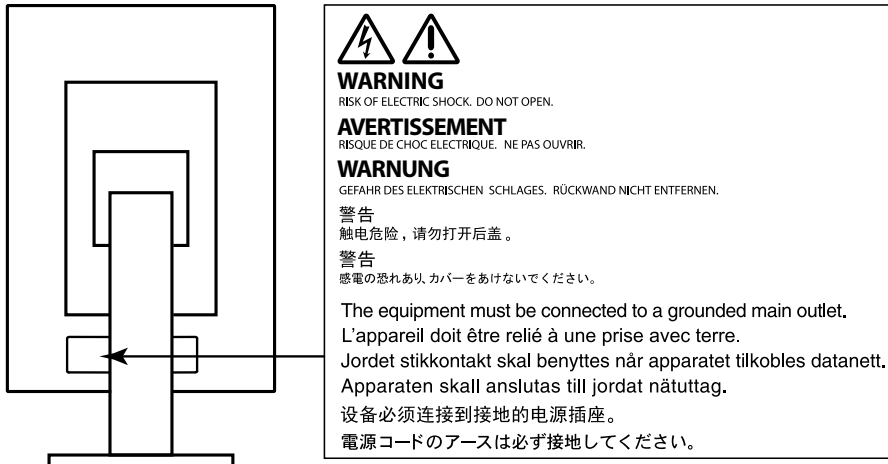



IMPORTANT

- This product has been adjusted specifically for use in the region to which it was originally shipped. If the product is used outside the region, it may not operate as specified in the specifications.
- To personal safety and proper maintenance, please read carefully this section and the caution statements on the monitor.

Location of the Caution Statements



Symbols on the unit

Symbol	This symbol indicates	
	Main Power Switch:	Press to turn the monitor's main power off.
	Main Power Switch:	Press to turn the monitor's main power on.
	Power button:	Press to turn the monitor's power on or off.
	Alternating current	
	Alerting electrical hazard	
	CAUTION:	Refer to "SAFETY SYMBOLS" (page 2).
	WEEE marking:	Product must be disposed of separately; materials may be recycled.
	CE marking:	EU conformity mark in accordance with the provisions of Council Directive 93/42/EEC and 2011/65/EU.
	Manufacturer	
	Date of manufacture	

WARNING

If the unit begins to emit smoke, smells like something is burning, or makes strange noises, disconnect all power connections immediately and contact your EIZO representative for advice.

Attempting to use a malfunctioning unit may result in fire, electric shock, or equipment damage.

Do not open the cabinet or modify the unit.

Opening the cabinet or modifying the unit may result in fire, electric shock, or burn.



Refer all servicing to qualified service personnel.

Do not attempt to service this product yourself as opening or removing covers may result in fire, electric shock, or equipment damage.

Keep small objects or liquids away from the unit.

Small objects accidentally falling through the ventilation slots into the cabinet or spillage into the cabinet may result in fire, electric shock, or equipment damage. If an object or liquid falls/spills into the cabinet, unplug the unit immediately. Have the unit checked by a qualified service engineer before using it again.



Place the unit at a sturdy and stable place.

A unit placed on an inadequate surface may fall and result in injury or equipment damage. If the unit falls, disconnect the power immediately and ask your local EIZO representative for advice. Do not continue using a damaged unit. Using a damaged unit may result in fire or electric shock.

Use the unit in an appropriate location.

Otherwise, fire, electric shock, or equipment damage may result.

- Do not place outdoors.
- Do not place in any form of transportation (ships, aircraft, trains, automobiles, etc.).
- Do not place in dusty or humid environments.
- Do not place in locations where water may be splashed on the screen (bathrooms, kitchens, etc.)
- Do not place in locations where steam comes in direct contact with the screen.
- Do not place near heat generating devices or humidifiers.
- Do not place in locations where the product is subject to direct sunlight.
- Do not place in environments with inflammable gas.
- Do not place in environments with corrosive gases (such as sulfur dioxide, hydrogen sulfide, nitrogen dioxide, chlorine, ammonia, and ozone)
- Do not place in environments with dust, components that accelerate corrosion in the atmosphere (such as sodium chloride and sulfur), conductive metals, and so on



To avoid danger of suffocation, keep the plastic packing bags away from babies and children.

Use the enclosed power cord and connect to the standard power outlet in your country.

Be sure to use within the rated voltage of the power cord. Otherwise, fire or electric shock may result.

Power supply: 100-240Vac 50/60Hz

To disconnect the power cord, grasp the plug firmly and pull.

Tugging on the cord may damage and result in fire or electric shock.



The equipment must be connected to a grounded main outlet.

Failure to do so may result in fire or electric shock.



Use the correct voltage.

- The unit is designed for use with a specific voltage only. Connection to another voltage than specified in this "Instructions for Use" may cause fire, electric shock, or equipment damage.
Power supply: 100-240Vac 50/60Hz
 - Do not overload your power circuit, as this may result in fire or electric shock.
-

 **WARNING**

Handle the power cord with care.

- Do not place the cord underneath the unit or other heavy objects.
- Do not pull on or tie the cord.

If the power cord becomes damaged, stop using it. Using of a damaged cord may result in fire or electric shock.



For electrical safety, do not connect or disconnect the power cord in the presence of patients.

Never touch the plug and power cord if it begins to thunder.

Touching them may result in electric shock.



When attaching an arm stand, please refer to the user's manual of the arm stand and install the unit securely.

Otherwise, the unit may become detached, resulting in injury and/or equipment damage. Before installation, make sure that desks, walls, or any other installation surface has adequate mechanical strength. If the unit falls, please ask your local EIZO representative for advice. Do not continue using a damaged unit. Using a damaged unit may result in fire or electric shock. When reattaching the tilt stand, please use the same screws and tighten them securely.

Do not touch a damaged LCD panel directly with bare hands.

Liquid crystal is poisonous. If any part of your skin comes in direct contact with the panel, wash thoroughly. If liquid crystal enters your eyes or mouth, immediately flush with large amounts of water and seek medical attention.



Fluorescent backlight lamps contain mercury (the products that have LED backlight lamps contain no mercury), dispose according to local, state or federal laws.

Exposure to elemental mercury can result in effects on the nervous system, including tremors, memory loss, and headaches.



CAUTION

Handle with care when carrying the unit.

Disconnect the power cord and cables when moving the unit. Moving the unit with the power cord or cables attached is dangerous and may result in injury.

Carry or place the unit according to the correct specified methods.

- When carrying, grasp and firmly hold the unit as shown in the illustration below.
- Monitors of size 30 inches and above are heavy. When unpacking and/or carrying the monitor, ensure at least two people are utilized.

Dropping the unit may result in injury or equipment damage.



Do not block the ventilation slots on the cabinet.

- Do not place any objects on the ventilation slots.
- Do not install the unit in a place with poor ventilation or inadequate space.
- Do not use the unit laid down or upside down.

Blocking the ventilation slots prevents proper airflow and may result in fire, electric shock, or equipment damage.



Do not touch the plug with wet hands.

Doing so may result in electrical shock.



Use an easily accessible power outlet.

This is to facilitate disconnecting the power in case of a problem.

Periodically clean the area around the power plug and the ventilation slot of the monitor.

Dust, water, or oil on the plug may result in fire.

Unplug the unit before cleaning it.

Cleaning the unit while it is plugged into a power outlet may result in electric shock.

If you plan to leave the unit unused for an extended period of time, disconnect the power cord from the wall socket after turning off the power switch for the safety and the power conservation.

This product is suitable for placing near patients, but not for direct contact with patients.

Notice for this monitor

Intended use

This product is intended to be used in displaying and viewing digital images, including standard and multi-frame digital mammography, for review, analysis and diagnosis by trained medical practitioners. It is specially designed for breast tomosynthesis applications.

Caution: Federal law (USA) restricts this device to sale by or on the order of a physician.

Attention

- This product may not be covered by warranty for uses other than those described in this manual.
- The specifications noted in this manual are only applicable when the following are used:
 - Power cords provided with the product
 - Signal cables specified by us
- Only use optional products manufactured or specified by us with this product.

Installation Requirements

- Carefully read the "PRECAUTIONS" (page 3) and always follow the instructions.
- When installing the monitor in a rack, ensure that there is adequate space around the sides, back and top of the monitor.

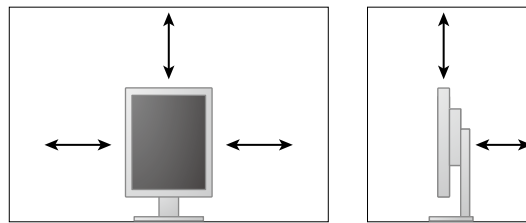

- Position the monitor so that there is no light to interfere with the screen.
- If you place this product on a lacquer-coated desk, the color may adhere to the bottom of the stand due to the composition of the rubber. Check the desk surface before use.

Maintenance

- The display quality of monitors is affected by the quality level of input signals and the degradation of the product. It is recommended that daily checkups and periodical constancy test be performed to comply with medical standards/guidelines according to your application. Use of the RadiCS monitor quality control software enables you to perform high-level total quality control that meets medical standards/guidelines.
- It takes about 15 minutes for the performance of electrical parts to stabilize. Please wait 15 minutes or more after the monitor power has been turned on or the monitor has recovered from the power saving mode, and then adjust the monitor.
- It takes about a few minutes for the image quality to reach acceptable level. Please wait a few minutes or more after the monitor power has been turned on or the monitor has recovered from the power saving mode, and then view images for diagnosis.
- Monitors should be set to a lower brightness to reduce changes in luminosity caused by long-term use and maintain a stable display. Periodically perform constancy tests. Calibrate if necessary. For details, refer to the User Manuals for the RadiCS/RadiCS LE monitor quality control software.
- To maintain the measurement accuracy of the integrated front sensor, perform periodical correlation using RadiCS/RadiCS LE.
- Parts (such as the LCD panel) may deteriorate over the long term. Periodically check that they are operating normally.

- When the screen image is changed after displaying the same image for extended periods of time, an afterimage may appear. Use the screen saver or power save function to avoid displaying the same image for extended periods of time.
- If the monitor displays continuously over a long period of time, dark smudges or burn-in may appear. To maximize the life of the monitor, we recommend the monitor be turned off periodically.
- The backlight of the LCD panel has a fixed lifetime. When the screen becomes dark or begins to flicker, please contact your local EIZO representative.
- The screen may have defective pixels or a small number of light dots on the screen. This is due to the characteristics of the panel itself, and is not a malfunction of the product.
- Do not press on the panel or edge of the frame strongly, as this may result in display malfunctions, such as interference patterns, etc. If pressure is continually applied to the panel, it may deteriorate or damage your panel. (If the pressure marks remain on the panel, leave the monitor with a black or white screen. The symptom may disappear.)
- Do not scratch or press on the panel with any sharp objects, as this may result in damage to the panel. Do not attempt to brush with tissues as this may scratch the panel.
- When the monitor is cold and brought into a room or the room temperature goes up quickly, dew condensation may occur on the interior and exterior surfaces of the monitor. In that case, do not turn the monitor on. Instead wait until the dew condensation disappears, otherwise it may cause some damage to the monitor.

Cleaning

Periodic cleaning is recommended to keep the monitor looking new and to prolong its operation lifetime.

Attention

- Do not use chemicals on a frequent basis. Chemicals such as alcohol and antiseptic solution may cause gloss variation, tarnishing, and fading of the cabinet or panel, and also quality deterioration of the image.
- Never use any thinner, benzene, wax, and abrasive cleaner, which may damage the cabinet or panel.
- Do not let chemicals come into direct contact with the monitor.

Note

- The optional ScreenCleaner is recommended for cleaning the cabinet and panel surface.
-

Gently wipe off any dirt on the cabinet or panel surface with a soft cloth soaked in a small amount of water or one of the chemicals listed below.

Chemicals that may be used for cleaning

Material name	Product name
Ethanol	Ethanol
Isopropyl alcohol	Isopropyl alcohol
Chlorhexidine	Hibitane
Benzalkonium chloride	Welpas
Alkyldiaminoethylglycine	Tego 51
Glutaral	Sterihyde
Glutaral	Cidex Plus28

To use the monitor comfortably

- Staring at the monitor for a long time tires your eyes. Take a 10-minute rest every hour.
- Look at the screen from a proper distance and from a proper angle.

CONTENTS

PRECAUTIONS	3
IMPORTANT	3
Notice for this monitor	7
CONTENTS	9
Chapter 1 Introduction	10
1-1. Features	10
1-2. Package Contents	11
1-3. EIZO LCD Utility Disk	11
● Disk contents and software overview	11
● Using RadiCS LE	11
1-4. Controls and Functions	12
1-5. Compatible Resolutions	13
Chapter 2 Connection	14
2-1. Connecting Cables	14
2-2. Making Use of USB (Universal Serial Bus)...	16
● Required system environment	16
● Connection procedure (Setup of USB function)	17
Chapter 3 Setting Up	18
3-1. Adjusting the Screen Height and Angle	18
3-2. Attaching Arm	19
Chapter 4 Troubleshooting	20
Chapter 5 Specifications	21
5-1. Specifications List	21
5-2. Main Default Settings	22
5-3. Dimensions	23
5-4. Accessories	23
Chapter 6 Glossary	24
Appendix	25
Trademark	25
License / Copyright	26
Medical Standard	26
FCC Declaration of Conformity	27
EMC Information	28
Recycling Information/ Informationen zum Thema Recycling/ Informations sur le recyclage/ Информация относно рециклиране	i

Chapter 1 Introduction

Thank you for purchasing our product.

1-1. Features

- 21.3 inches
- Supports a resolution of 5M pixels (Portrait: 2048 × 2560 dots (H × V))
- Uses high-contrast panel (1500 : 1).
Enables the display of sharp images.
- Applicable to DisplayPort (applicable to 8 bit or 10 bit, not applicable to audio signals)
- The daisy-chain function is included enabling multiple monitors to be connected with the DisplayPort cable.
A graphic board supporting DisplayPort1.2 is required. For details, refer to the EIZO website.
<http://www.eizoglobal.com>
- The CAL Switch function allows the user to select the display mode optimum to the displayed image.
Refer to the Installation Manual (on the CD-ROM).
- Selectable DICOM (page 24) Part 14 complied screen.
- The quality control software “RadiCS LE” used to calibrate the monitor and to manage the history is included.
See “1-3. EIZO LCD Utility Disk” (page 11).
- Power saving function
This product is equipped with power saving function.
 - 0 W power consumption when the main power is off
Equipped with main power switch.
When not using the monitor, you can turn off the main power supply so that the power is cut completely.
 - Presence Sensor
The sensor on the front side of the monitor detects the movement of a person. When a person moves away from the monitor, the monitor shifts to the power saving mode automatically and does not display the images on the screen. Therefore, the function reduces the power consumption.
Refer to the Installation Manual (on the CD-ROM).
- Low-profile and lightweight design
- Long service life LED backlight LCD panel
- Built-in ambient light sensor
Depending on the environment, the sensor sometimes indicates different values from those measured by a stand-alone illuminance meter.
The usage of this sensor requires the quality control software “RadiCS/RadiCS LE” and the measurement is always triggered by the user’s operation in the corresponding menu. For further details about the measured value and how to execute the measurement, refer to the RadiCS/RadiCS LE User’s Manual (on the CD-ROM).

1-2. Package Contents

Check that all the following items are included in the packaging box. If any items are missing or damaged, contact your local EIZO representative.

Note

- Please keep the packaging box and materials for future movement or transport of the monitor.

- Monitor
- Power cord

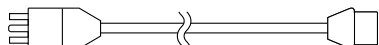

- Digital signal cable : PP300
DisplayPort - DisplayPort

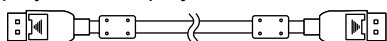

- Digital signal cable : DD300DL
DVI - DVI (Dual Link)

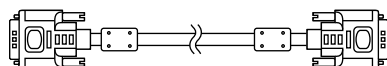

- USB cable : UU300

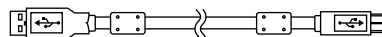

- EIZO LCD Utility Disk (CD-ROM)
- Instructions for Use (this manual)

1-3. EIZO LCD Utility Disk

An “EIZO LCD Utility Disk” (CD-ROM) is supplied with this product. The following table shows the disk contents and the overview of the software programs.

● Disk contents and software overview

The disk includes quality control software and User’s Manual. Refer to Readme.txt file on the disk for software startup procedures or file access procedures.

Contents	Overview
Readme.txt file	
RadiCS LE (for Windows)	Quality control software for calibrating the monitor and managing the calibration history.
Installation Manual of this monitor (PDF file)	
“Instructions for Use” of this monitor (PDF file)	

● Using RadiCS LE

For the installation and use of RadiCS LE, refer to the User’s Manual on the disk.

When using this software, you will need to connect a PC to the monitor with the supplied USB cable (see “2-2. Making Use of USB (Universal Serial Bus)” (page 16)).

Note

- Using DDC communication allows you to use RadiCS LE without having to use the USB cable. For information on how to configure DDC communication, refer to the Installation Manual (on the CD-ROM).

1-4. Controls and Functions

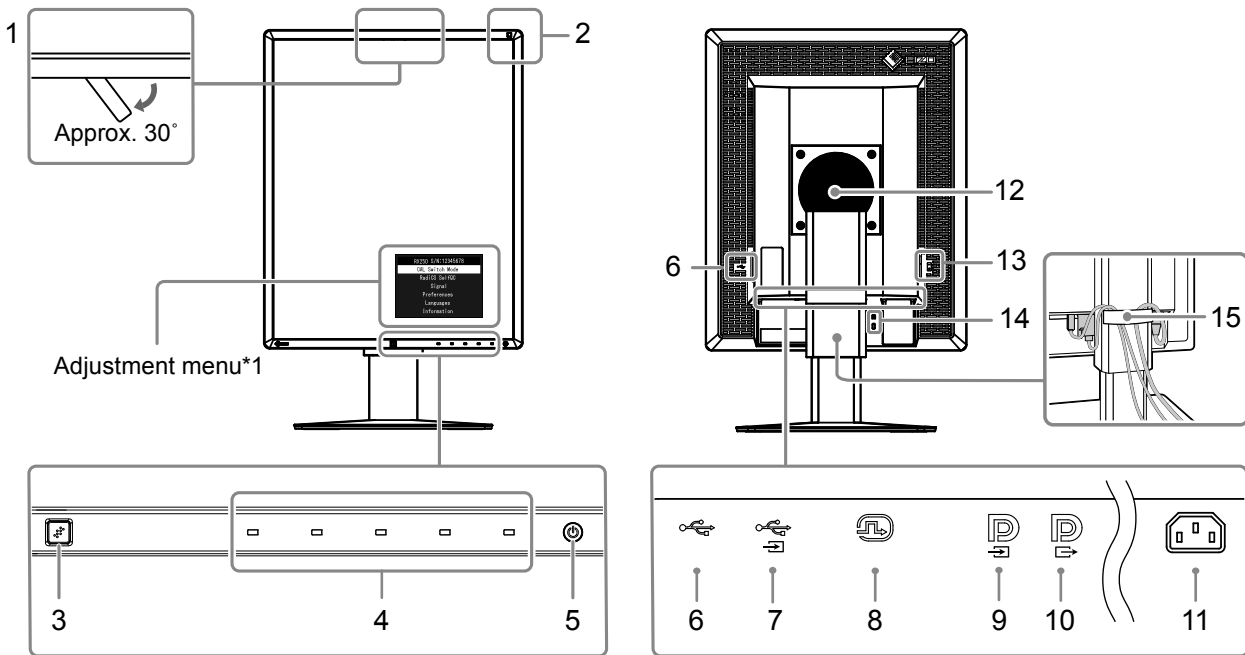

1. Integrated Front Sensor (Mobile)	Detects the movement of a person in front of the monitor.
2. Ambient Light Sensor	Measures the environmental illumination.
3. Presence Sensor	Detects the movement of a person in front of the monitor.
4. Operation switches	Displays the menu. Follow the guide to perform the desired operations.
5. ⏻ switch	<ul style="list-style-type: none"> • Turns the power on or off. • Indicates the monitor's operation status. Green: Operating, Orange: Power saving mode, Off: Main power/power off
6. USB downstream port	Connects a peripheral USB device.
7. USB upstream port	Connects the USB cable to use the software that needs USB connection, or to use USB Hub function.
8. DVI-D connector	Connect it to the PC.
9. DisplayPort input connector	Connect it to the PC. To set up a daisy-chain connection, connect the cable to the output connector of an upstream monitor.
10. DisplayPort output connector	To set up a daisy-chain connection, connect the cable to the input connector of a downstream monitor.
11. Power connector	Connects the power cord.
12. Stand	Used to adjust the height and angle of the monitor screen.
13. Main power switch	Turns the main power on or off. ○ : Off : On
14. Security lock slot	Complies with Kensington's MicroSaver security system.
15. Cable holder	Covers the monitor cables.

*1 For instructions for use, refer to the Installation Manual (on the CD-ROM).

1-5. Compatible Resolutions

The monitor supports the following resolutions.

√ : Supported

Resolution	vertical scan frequency	DVI		DisplayPort		SDG ^{*1}
		Portrait	Landscape	Portrait	Landscape	Portrait
720×400	70 Hz	√	√	√	√	√
640×480	60 Hz	√	√	√	√	√
800×600	60 Hz	√	√	√	√	√
1024×768	60 Hz	√	√	√	√	√
1280×1024	60 Hz	√	√	√	√	√
1600×1200	60 Hz	√	√	√	√	√
2560×2048	50 Hz	-	√ ^{*2}	-	√ ^{*3}	-
2048×2560	50 Hz	√ ^{*2}	-	√ ^{*3}	-	-
2560×2048	48 Hz	-	-	-	√ ^{*4}	-
2048×2560	48 Hz	-	-	√ ^{*4}	-	-
2560×2048	25 Hz	-	√	-	-	-
2048×2560	25 Hz	√	-	-	-	√

*1 In order to display, a compatible graphics board is required.

*2 A dual link signal only.

*3 Only when the "DisplayPort version" is "1.1".

*4 Only when the "DisplayPort version" is "1.2".

Chapter 2 Connection

2-1. Connecting Cables

Attention

- Check that the monitor and the PC are powered off.
- When replacing the current monitor with this monitor, refer to “1-5. Compatible Resolutions” (page 13) to change the PC settings for resolution and vertical scan frequency to those that are available for this monitor, before connecting the PC.

1. Turn the monitor screen 90° in clockwise direction.

The landscape position is the default monitor orientation.

Attention



- Before turning the monitor screen, raise it to the highest position.

2. Connect signal cables.

Check the shapes of the connectors, and connect the cables. After connecting the DVI cable, tighten the fasteners to secure the connector.

Connecting to a single PC

Attention

- The DisplayPort connectors of the monitor consist of input  and output . When connecting a monitor to a PC, connect the cable to input connector .

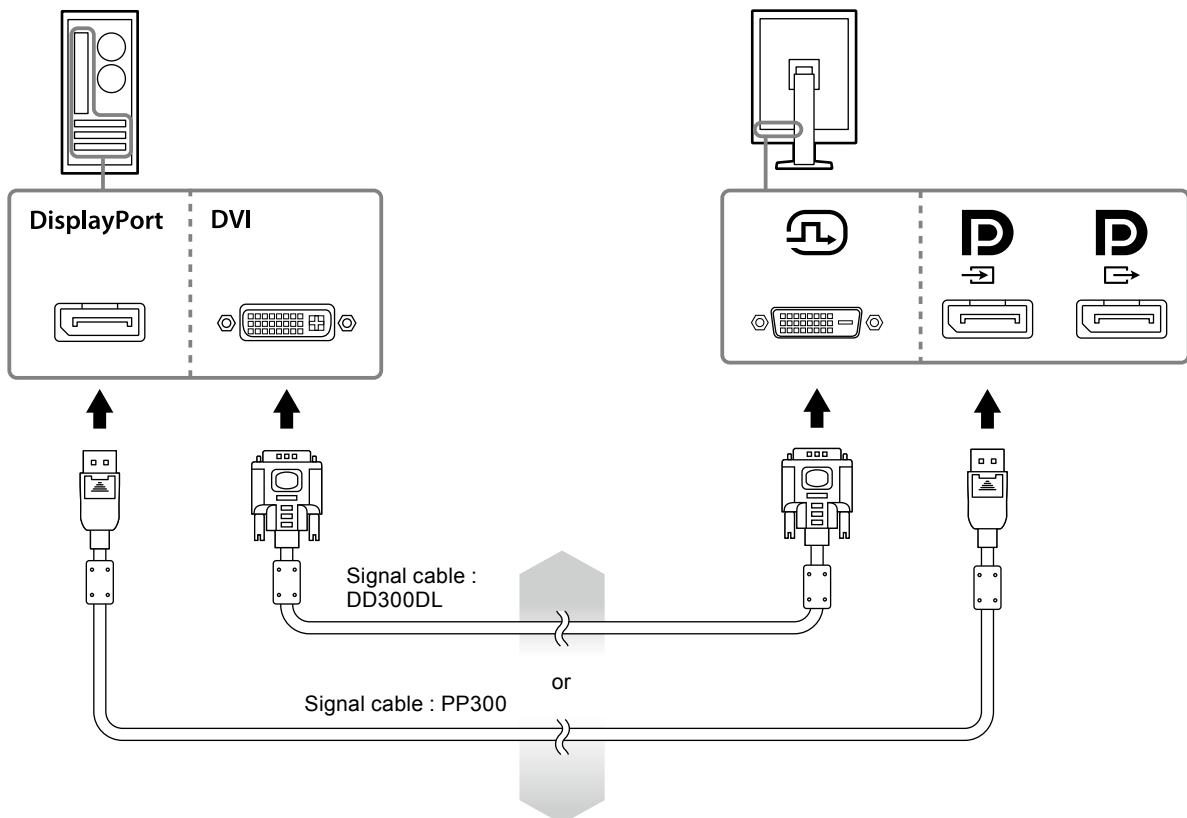

Connecting to multiple PCs

For information on how to switch the input signals, refer to the Setup manual (on the CD-ROM).

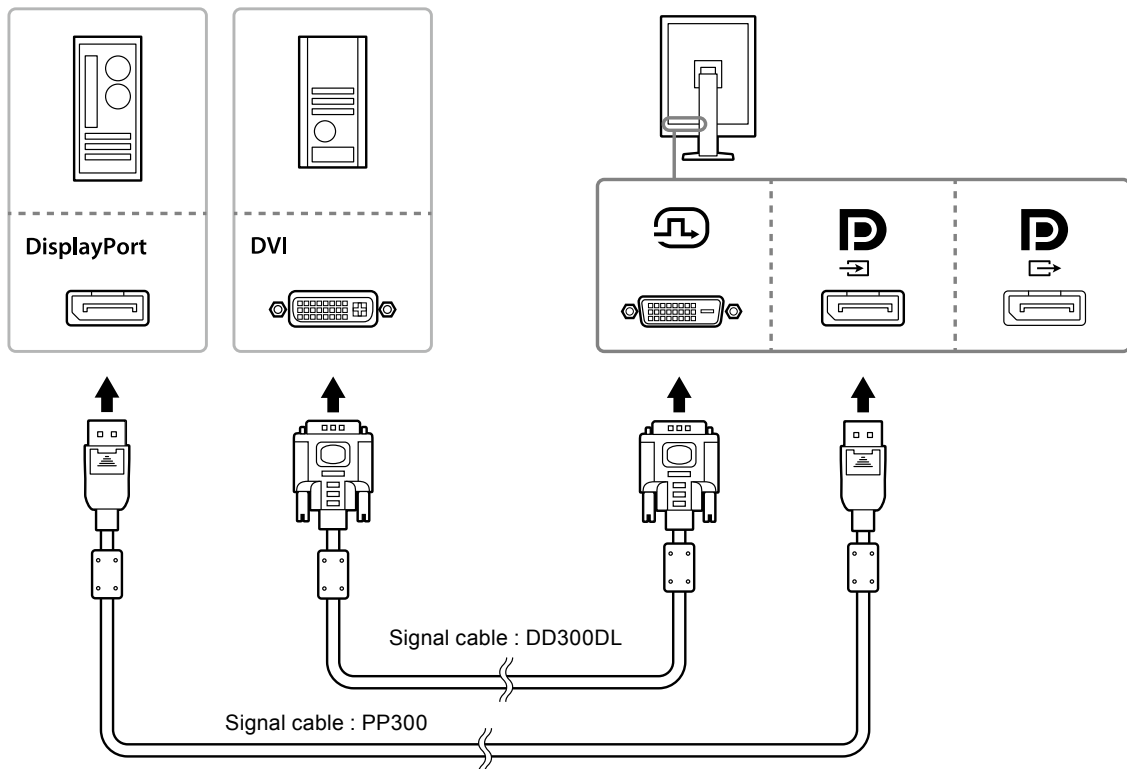

Daisy-chaining multiple monitors

Attention

- Visit the EIZO website for information about monitors and graphic boards that can be used for the daisy-chain connection: <http://www.eizoglobal.com>
- Remove the **D** cap before connecting the signal cable.

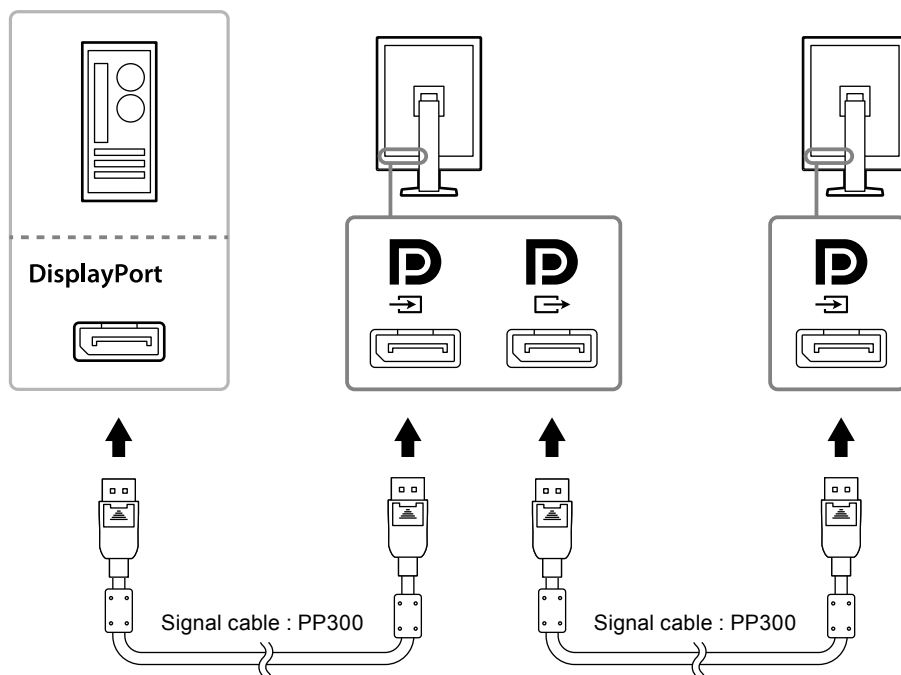

3. Plug the power cord into a power outlet and the power connector on the monitor.

4. Connect the USB cable when using RadiCS LE.

For information about the connection to the USB upstream port, refer to “2-2. Making Use of USB (Universal Serial Bus)” (page 16).

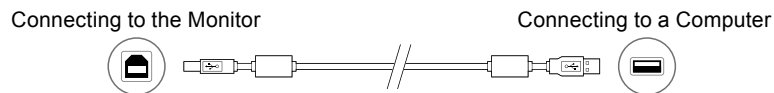

Note

- Using DDC communication allows you to use RadiCS LE without having to use the USB cable. For information on how to configure DDC communication, refer to the Installation Manual (on the CD-ROM).
-

5. Touch to turn on the power to the monitor.

The monitor's power indicator lights up green.

6. Turn on the PC.

The screen image appears.

If an image does not appear, refer to “Chapter 4 Troubleshooting” (page 20) for additional advice.

Attention

- For the maximum power saving, it is recommended that the Power button be turned off. When not using the monitor, you can turn off the main power supply or disconnect the power plug so that the power is cut completely.
-

Note

- In order to maximize the monitor life and to minimize luminance deterioration as well as power consumption, proceed the following:
 - Use the power saving function of the computer.
 - Turn off the monitor and PC after using them.
-

2-2. Making Use of USB (Universal Serial Bus)

This monitor has a hub compatible with USB. Connected to a PC compatible with USB or another USB hub, this monitor functions as a USB hub allowing connection to peripheral USB devices.

● Required system environment

- A PC equipped with a USB port or another USB hub connected to a USB compatible PC
 - Windows 10 / Windows 8.1 / Windows 8 / Windows 7 / Windows Vista / Windows XP, or Mac OS X 10.2 or later
 - USB cable
-

Attention

- This monitor may not work depending on PC, OS or peripheral devices to be used. For USB compatibility of peripheral devices, contact their manufacturers.
 - Devices connected to the USB downstream port still work when the monitor is in power saving mode or when the power is switched off using only the power button of the monitor. Therefore, power consumption of the monitor varies with connected devices even in the power saving mode.
 - When the main power switch is Off, device connected to the USB port will not operate.
-

● Connection procedure (Setup of USB function)

Procedure

1. Connect the monitor first to a PC using the signal cable, and run the PC.
2. Connect the supplied USB cable between the USB downstream port of a USB compatible PC (or another USB hub) and the monitor's USB upstream port.

The USB hub function is set up automatically upon connection of the USB cable.

3. Connect the peripheral USB device to the USB downstream port of the monitor.

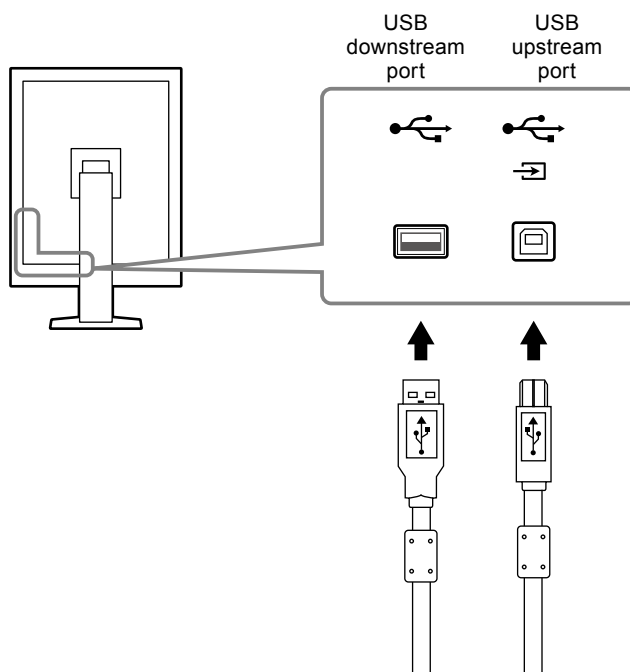

Chapter 3 Setting Up

3-1. Adjusting the Screen Height and Angle

Hold left and right edge of the monitor with both hands, and adjust the screen height, tilt and swivel of the screen to the best condition for working.

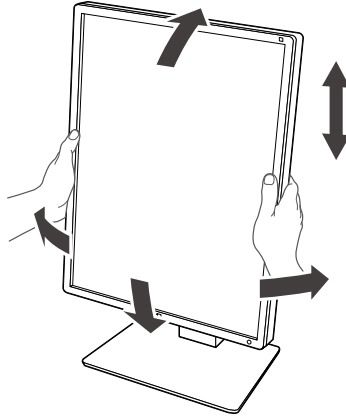

Attention

- After carrying out the adjustment, make sure that the cables are connected correctly, and put them through the cable holder.
-

3-2. Attaching Arm

An optional arm (or an optional stand) can be attached by removing the stand section. For supported optional arms (or optional stands), refer to the EIZO website: <http://www.eizoglobal.com>

Attention

- When attaching an arm or stand, follow the instructions of their User's Manual.
- When using another manufacturer's arm or stand, confirm the following in advance and select one conforming to the VESA standard.
 - Clearance between the screw holes: 100mm × 100 mm
 - VESA mount of the arm or stand, external dimensions: 122 mm x 122 mm or less
 - Strong enough to support weight of the monitor unit (except the stand) and attachments such as cables.
- When using another manufacturer's arm or stand, use the following screws to secure it.
 - Screws fixing the stand to the monitor
- When using an arm or stand, attach it to meet the following tilt angles of the monitor.
 - Up 45°, down 45° (when the portrait orientation is used, and when rotated 90° counterclockwise for landscape display)
- Connect the cables after attaching an arm or stand.
- Do not move the removed stand up and down. Doing so may result in injury or device damage.
- The monitor and arm or stand are heavy. Dropping them may result in injury or equipment damage.
- Periodically check the tightness of the screws. If not sufficiently tight, the monitor may detach from the arm, which may result in injury or equipment damage.

Procedure

1. Lay the LCD monitor on a soft cloth spread over on a stable surface with the panel surface facing down.

2. Remove the stand.

Prepare a screwdriver. Loosen the screws (four) securing the unit and the stand with the screwdriver.



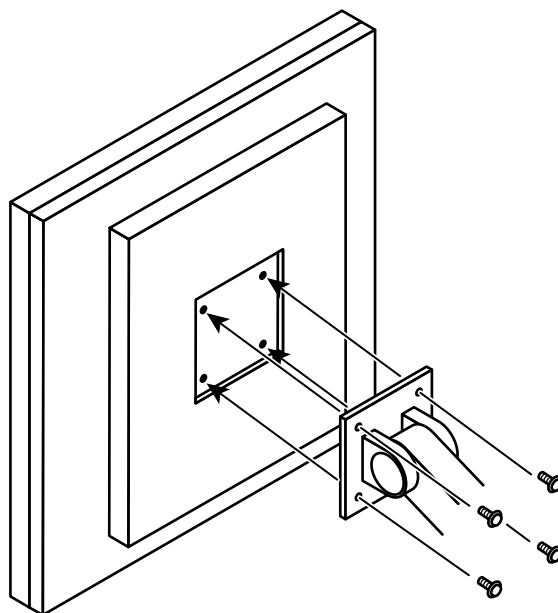

3. Attach the arm or stand to the monitor.

Use the screws that you removed in step 2 to attach the arm (or stand) to the monitor.



Chapter 4 Troubleshooting

If a problem still remains after applying the suggested remedies, contact your local EIZO representative.

Problem	Possible cause and remedy
<p>1. No picture</p> <ul style="list-style-type: none"> Power indicator does not light. <hr/> <ul style="list-style-type: none"> Power indicator is lighting green. <hr/> <ul style="list-style-type: none"> Power indicator is lighting orange. <hr/> <ul style="list-style-type: none"> Power indicator is flashing orange and green. 	<ul style="list-style-type: none"> Check whether the power cord is connected properly. Turn the main power switch on. Touch . Turn off the main power, and then turn it on again. <hr/> <ul style="list-style-type: none"> Increase "Brightness" in the Adjustment menu. For details, refer to the Installation Manual (on the CD-ROM). Turn off the main power, and then turn it on again. <hr/> <ul style="list-style-type: none"> Switch the input signal. For details, refer to the Installation Manual (on the CD-ROM). Move the mouse or press any key on the keyboard. Check whether the PC is turned on. When Presence Sensor is set to "On", the monitor may have shifted to the power saving mode. Come near to the monitor. Check if the signal cable is connected to  for inputting the DisplayPort signal.  is used for output when a daisy-chain connection is set up. Turn off the main power, and then turn it on again. <hr/> <ul style="list-style-type: none"> Connect via the signal cable specified by EIZO. Turn off the main power, and then turn it on again. When connected to DisplayPort, switch the version of DisplayPort to 1.1. For details, refer to the Installation Manual (on the CD-ROM).
<p>2. The message below appears.</p> <hr/> <ul style="list-style-type: none"> This message appears when no signal is input. Example: <div data-bbox="285 1272 657 1408" data-label="Image"> </div> <hr/> <ul style="list-style-type: none"> The message shows that the input signal is out of the specified frequency range. Example: <div data-bbox="285 1664 657 1800" data-label="Image"> </div>	<p>This message appears when the signal is not input correctly even when the monitor functions properly.</p> <hr/> <ul style="list-style-type: none"> The message shown left may appear, because some PCs do not output the signal soon after power-on. Check whether the PC is turned on. Check whether the signal cable is connected properly. Switch the input signal. For details, refer to the Installation Manual (on the CD-ROM). When connected to DisplayPort, switch the version of DisplayPort to 1.1. Check if the signal cable is connected to  for inputting the DisplayPort signal.  is used for output when a daisy-chain connection is set up. Turn off the main power, and then turn it on again. <hr/> <ul style="list-style-type: none"> Check whether the PC is configured to meet the resolution and vertical scan frequency requirements of the monitor (see "1-5. Compatible Resolutions" (page 13)). Reboot the PC. Select an appropriate setting using the graphics board's utility. Refer to the manual of the graphics board for details.

Chapter 5 Specifications

5-1. Specifications List

LCD Panel	Type	IPS
	Backlight	LED
	Size	54.1 cm (21.3 inch)
	Resolution	5M pixels (Portrait orientation: 2048 dots × 2560 lines (H × V))
	Display Size (H x V)	337.9 mm × 422.4 mm (Portrait orientation)
	Pixel Pitch	0.165 mm
	Display Tones	Simultaneous display of 1,024 tones out of 16,369 tones ("Sub Pixel Drive": When "Off" is set) Simultaneous display of 1,024 tones out of 4,093 tones ("Sub Pixel Drive": When "On" is set)
	Viewing Angles (H / V, typical)	178° / 178°
	Recommended Brightness	600 cd/m ²
	Response Time (typical)	25 ms (black -> white -> black)
Video Signals	Input Terminals	DVI-D (Dual Link) × 1, DisplayPort × 1
	Output Terminal	DisplayPort × 1
	Digital Scanning Frequency (H / V)	31 kHz - 135 kHz / 59 Hz - 61 Hz (VGA TEXT: 69 Hz - 71 Hz, QSXGA: 24 Hz - 51 Hz (DVI), QSXGA: 23 Hz - 51 Hz (DisplayPort)) Frame synchronous mode : 23.5 Hz - 25.5 Hz, 47.0 Hz - 51.0 Hz
	Dot clock	25 MHz - 290 MHz
USB	Port	Upstream port × 1, Downstream port × 2
	Standard	USB Specification Revision 2.0
Power	Input	100 - 240 VAC +/-10%, 50/60 Hz, 1.0 A - 0.45 A
	Maximum Power Consumption	95 W or less
	Power Save Mode	1.0W or less (When DVI input is used, no USB device is connected, "Auto Input Detection": "Off", "Power Save": "High", "DDC": "Off", "DC5V Output": "Off", "DP Power Save": "On", "DisplayPort version": "1.1", no external load is connected)
	Standby Mode	1.0W or less (When no USB device is connected, "DP Power Save": "On", "DC5V Output": "Off", "DisplayPort version": "1.1", "DDC": "Off", no external load is connected)
Physical Specifications	Dimensions	367 mm × 505 mm - 595 mm × 264 mm (W × H × D) (Tilt: 30°)
	Dimensions (Without Stand)	367 mm × 452 mm × 78 mm (W × H × D)
	Net Weight	Approx. 8.1 kg
	Net Weight (Without Stand)	Approx. 5.3kg
	Height Adjustment Range	90mm (Tilt: 0°)
	Tilt	Up 30°, down 5°
	Swivel	70°
	Rotation	90° (counterclockwise for portrait display)

Operating Environmental Requirements	Temperature:	0°C to 35°C (32°F to 95°F)
	Humidity	20% to 80% R.H. (no condensation)
	Air pressure	540 hPa to 1060 hPa
Transportation/ Storage Environmental Requirements	Temperature	-20°C to 60°C (32°F to 95°F)
	Humidity	10% to 90% R.H. (no condensation)
	Air pressure	200 hPa to 1060 hPa

5-2. Main Default Settings

CAL Switch Mode: The factory default display setting is DICOM mode.

Mode	Brightness	Gamma value
1-DICOM	600 cd/m ²	DICOM
2-CAL1	500 cd/m ²	DICOM
3-CAL2	400 cd/m ²	DICOM

Others

Auto Input Detection	Off
Power Save	High
Indicator	4
Presence Sensor	Off
Languages	English
On-Screen Logo ^{*1}	Off
Image Rotation ^{*1}	Portrait
DDC ^{*1}	Auto
DC5V Output ^{*1}	Off
DP Power Save ^{*1}	Off
Grayscale Warning ^{*1}	On
Sharpness Recovery ^{*1}	On
Sub Pixel Drive ^{*1,*2}	Off
Preferred Refresh Rate ^{*1}	Low
DisplayPort version ^{*1}	1.1

*1 These menus cannot be initialized with "Monitor Reset". (Refer to the Installation Manual (on the CD-ROM)).

*2 Leave the default setting "Off" as it is.

Attention

- If "Sub Pixel Drive" is set to "On", the screen is not displayed properly.

For information on how to reconfigure, refer to the Installation Manual (on the CD-ROM).

5-3. Dimensions

Unit: mm

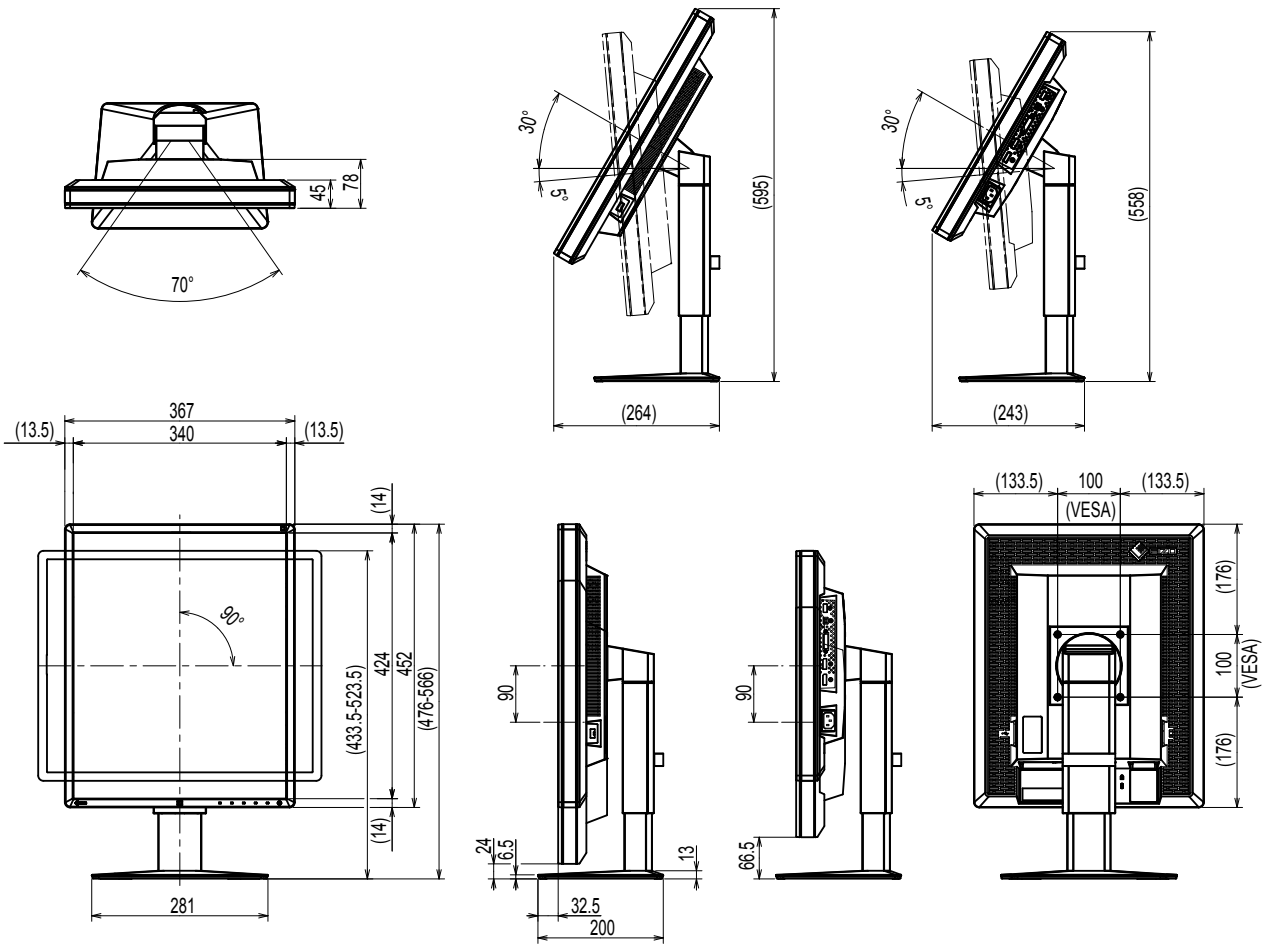

5-4. Accessories

Calibration Kit	EIZO "RadiCS UX1" Ver. 4.4.2 or later EIZO "RadiCS Version Up Kit" Ver. 4.4.2 or later
Network QC Management Software	EIZO "RadiNET Pro" Ver. 4.4.2 or later EIZO "RadiNET Pro Lite" Ver. 4.4.2 or later
Cleaning Kit	EIZO "ScreenCleaner"
LCD protection panel	EIZO "RP-917"

For the latest information about the accessories and information about the latest compatible graphics board, refer to our web site. <http://www.eizoglobal.com>

Chapter 6 Glossary

Daisy-chain connection

A method of connecting two or more monitors to a PC in a daisy-chain.

DDC (Display Data Channel)

VESA provides the standardization for the interactive communication of the setting information, etc. between a PC and the monitor.

DICOM (Digital Imaging and Communication in Medicine)

The DICOM standard was developed by the American College of Radiology and the National Electrical Manufacturer's Association of the USA.

The DICOM compatible device connection enables to transfer the medical image and information. The DICOM, Part 14 document defines the digital, grayscale medical image display.

DisplayPort

This is the interface standard for image signals standardized in accordance with VESA. It was developed with the aim of replacing the conventional DVI and analog interfaces, and it can transmit high resolution signals and sound signals, which DVI does not support. The standard size and mini size connectors have been standardized.

DVI (Digital Visual Interface)

DVI is a digital interface standard. DVI allows direct transmission of the PC's digital data without loss.

This adopts the TMDS transmission system and DVI connectors. There are two types of DVI connectors. One is a DVI-D connector for digital signal input only. The other is a DVI-I connector for both digital and analog signal inputs.

DVI DMPM (DVI Digital Monitor Power Management)

DVI DMPM is a digital interface power saving function. The "Monitor ON (operating mode)" and "Active Off (power saving mode)" are indispensable for DVI DMPM as the monitor's power mode.

Resolution

The LCD panel consists of numerous pixels of specified size, which are illuminated to form images. This monitor consists of horizontal 2048 pixels and 2560 vertical pixels. At a resolution of 2048×2560 (Portrait orientation), all pixels are illuminated as a full screen (1:1).

Appendix

Trademark

The terms HDMI and HDMI High-Definition Multimedia Interface, and the HDMI Logo are trademarks or registered trademarks of HDMI Licensing, LLC in the United States and other countries.

The DisplayPort Compliance Logo and VESA are registered trademarks of the Video Electronics Standards Association.

Acrobat, Adobe, Adobe AIR, and Photoshop are registered trademarks of Adobe Systems Incorporated in the United States and other countries.

AMD Athlon, AMD Opteron, and FreeSync are trademarks of Advanced Micro Devices, Inc.

Apple, ColorSync, eMac, iBook, iMac, iPad, Mac, MacBook, Macintosh, Mac OS, PowerBook, and QuickTime are registered trademarks of Apple Inc.

ColorMunki, Eye-One, and X-Rite are registered trademarks or trademarks of X-Rite Incorporated in the United States and/or other countries.

ColorVision and ColorVision Spyder2 are registered trademarks of DataColor Holding AG in the United States.

Spyder3, Spyder4 and Spyder5 are trademarks of DataColor Holding AG.

ENERGY STAR is a registered trademark of the United States Environmental Protection Agency in the United States and other countries.

GRACoL and IDEAlliance are registered trademarks of International Digital Enterprise Alliance.

Linux is a registered trademark of Linus Torvalds.

NEC is a registered trademark of NEC Corporation.

PC-9801 and PC-9821 are trademarks of NEC Corporation.

NextWindow is a trademark of NextWindow Ltd.

Intel, Intel Core, Pentium, and Thunderbolt are trademarks of Intel Corporation in the U.S. and/or other countries.

PowerPC is a registered trademark of International Business Machines Corporation.

PlayStation is a registered trademark of Sony Computer Entertainment Inc.

PSP and PS3 are trademarks of Sony Computer Entertainment Inc.

RealPlayer is a registered trademark of RealNetworks, Inc.

Red Hat is a registered trademark of Red Hat, Inc.

TouchWare is a trademark of 3M Touch Systems, Inc.

Windows, Windows Media, Windows Vista, SQL Server, Xbox 360, and Internet Explorer are registered trademarks of Microsoft Corporation in the United States and other countries.

YouTube and Chrome are registered trademarks of Google Inc.

Firefox is a registered trademark of the Mozilla Foundation.

Kensington and MicroSaver are registered trademarks of ACCO Brands Corporation.

EIZO, the EIZO Logo, ColorEdge, DuraVision, FlexScan, FORIS, RadiCS, RadiForce, RadiNET, Raptor, and ScreenManager are registered trademarks of EIZO Corporation in Japan and other countries.

ColorNavigator, EcoView NET, EIZO EasyPIX, EIZO Monitor Configurator, EIZO ScreenSlicer, G-Ignition, i•Sound, Re/Vue, Screen Administrator and UniColor Pro are trademarks of EIZO Corporation.

All other company and product names are trademarks or registered trademarks of their respective owners.

License / Copyright

A round gothic bold bit map font designed by Ricoh is used for the characters displayed on this product.

Medical Standard

- It shall be assured that the final system is in compliance to IEC60601-1-1 requirement.
- Power supplied equipment can emit electromagnetic waves, that could influence, limit or result in malfunction of the monitor. Install the equipment in a controlled environment, where such effects are avoided.

Classification of Equipment

- Type of protection against electric shock : Class I
- EMC class: EN60601-1-2:2007 Group 1 Class B
- Classification of medical device (MDD 93/42/EEC): Class I
- Mode of operation : Continuous
- IP Class : IPX0

FCC Declaration of Conformity

For U.S.A. , Canada, etc. (rated 100-120 Vac) Only

FCC Declaration of Conformity

We, the Responsible Party

EIZO Inc.

5710 Warland Drive, Cypress, CA 90630

Phone: (562) 431-5011

declare that the product

Trade name: EIZO

Model: RadiForce GX550

is in conformity with Part 15 of the FCC Rules. Operation of this product is subject to the following two conditions: (1) this device may not cause harmful interference, and (2) this device must accept any interference received, including interference that may cause undesired operation.

This equipment has been tested and found to comply with the limits for a Class B digital device, pursuant to Part 15 of the FCC Rules. These limits are designed to provide reasonable protection against harmful interference in a residential installation. This equipment generates, uses, and can radiate radio frequency energy and, if not installed and used in accordance with the instructions, may cause harmful interference to radio communications. However, there is no guarantee that interference will not occur in a particular installation. If this equipment does cause harmful interference to radio or television reception, which can be determined by turning the equipment off and on, the user is encouraged to try to correct the interference by one or more of the following measures.

- * Reorient or relocate the receiving antenna.
- * Increase the separation between the equipment and receiver.
- * Connect the equipment into an outlet on a circuit different from that to which the receiver is connected.
- * Consult the dealer or an experienced radio/TV technician for help.

Changes or modifications not expressly approved by the party responsible for compliance could void the user's authority to operate the equipment.

Note

Use the attached specified cable below or EIZO signal cable with this monitor so as to keep interference within the limits of a Class B digital device.

- AC Cord
- Shielded Signal Cable (enclosed)

Canadian Notice

This Class B digital apparatus complies with Canadian ICES-003.

Cet appareil numérique de la classe B est conforme à la norme NMB-003 du Canada.

EMC Information

Essential performance of RadiForce series is to display images and operate functions normally.



CAUTION

The RadiForce series requires special precautions regarding EMC and need to be installed, put into service and used according to the following information.

Do not use any cables other than the cables that provided or specified by us.

Using other cables may cause the increase of emission or decrease of immunity.

Cable Length: Max. 3m

Do not put any portable and mobile RF communications equipment close to the RadiForce series. Doing so may affect the RadiForce series.

The RadiForce series should not be used adjacent to or stacked with other equipment. If adjacent or stacked use is necessary, the equipment or system should be observed to verify normal operation in the configuration in which it will be used.

Anyone who connects additional equipment to the signal input part or signal output parts, configuring a medical system, is responsible that the system complies with the requirements of IEC/EN60601-1-2.

Guidance and manufacturer's declaration - electromagnetic emissions		
The RadiForce series is intended for use in the electromagnetic environment specified below. The customer or the user of the RadiForce series should assure that it is used in such an environment.		
Emission test	Compliance	Electromagnetic environment - guidance
RF emissions CISPR11/EN55011	Group 1	The RadiForce series uses RF energy only for its internal function. Therefore, its RF emission are very low and are not likely to cause any interference in nearby electronic equipment.
RF emissions CISPR11/EN55011	Class B	The RadiForce series is suitable for use in all establishments, including domestic establishments and those directly connected to the public low-voltage power supply network that supplies buildings used for domestic purposes.
Harmonic emissions IEC/EN61000-3-2	Class D	
Voltage fluctuations / flicker emissions IEC/EN61000-3-3	Complies	

Guidance and manufacturer's declaration - electromagnetic immunity			
The RadiForce series is intended for use in the electromagnetic environment specified below. The customer or the user of the RadiForce series should assure that it is used in such an environment.			
Immunity test	IEC/EN60601 test level	Compliance level	Electromagnetic environment - guidance
Electrostatic discharge (ESD) IEC/EN61000-4-2	±6kV contact ±8kV air	±6kV contact ±8kV air	Floors should be wood, concrete or ceramic tile. If floors are covered with synthetic material, the relative humidity should be at least 30%.
Electrical fast transient / burst IEC/EN61000-4-4	±2kV for power supply lines ±1kV for input/output lines	±2kV for power supply lines ±1kV for input/output lines	Mains power quality should be that of a typical commercial or hospital environment.
Surge IEC/EN61000-4-5	±1kV line(s) to line(s) ±2kV line(s) to earth	±1kV line(s) to line(s) ±2kV line(s) to earth	Mains power quality should be that of a typical commercial or hospital environment.
Voltage dips, short interruptions and voltage variations on power supply input lines IEC/EN61000-4-11	<5% U _T (>95% dip in U _T) for 0.5 cycle 40% U _T (60% dip in U _T) for 5 cycles 70% U _T (30% dip in U _T) for 25 cycles <5% U _T (>95% dip in U _T) for 5sec	<5% U _T (>95% dip in U _T) for 0.5 cycle 40% U _T (60% dip in U _T) for 5 cycles 70% U _T (30% dip in U _T) for 25 cycles <5% U _T (>95% dip in U _T) for 5sec	Mains power quality should be that of a typical commercial or hospital environment. If the user of the RadiForce series requires continued operation during power mains interruptions, it is recommended that the RadiForce series be powered from an uninterruptible power supply or a battery.
Power frequency (50/60Hz) magnetic field IEC/EN61000-4-8	3A/m	3A/m	Power frequency magnetic fields should be at levels characteristic of a typical location in a typical commercial or hospital environment.
NOTE U _T is the a.c. mains voltage prior to application of the test level.			

Guidance and manufacturer's declaration - electromagnetic immunity

The RadiForce series is intended for use in the electromagnetic environment specified below. The customer or the user of the RadiForce series should assure that it is used in such an environment.

Immunity test	IEC/EN60601 test level	Compliance level	Electromagnetic environment - guidance
Conducted RF IEC/EN61000-4-6	3Vrms 150kHz to 80MHz	3Vrms	<p>Portable and mobile RF communications equipment should be used no closer to any part of the RadiForce series, including cables, than the recommended separation distance calculated from the equation applicable to the frequency of the transmitter.</p> <p>Recommended Separation distance</p> $d = 1.2 \sqrt{P}$ $d = 1.2 \sqrt{P}, 80\text{MHz to } 800\text{MHz}$ $d = 2.3 \sqrt{P}, 800\text{MHz to } 2.5\text{GHz}$ <p>Where "P" is the maximum output power rating of the transmitter in watts (W) according to the transmitter manufacturer and "d" is the recommended separation distance in meters (m).</p> <p>Field strengths from fixed RF transmitters, as determined by an electromagnetic site survey^a, should be less than the compliance level in each frequency range^b.</p> <p>Interference may occur in the vicinity of equipment marked with the following symbol.</p> 
Radiated RF IEC/EN61000-4-3	3V/m 80MHz to 2.5GHz	3V/m	

NOTE 1 At 80 MHz and 800 MHz, the higher frequency range applies.

NOTE 2 These guidelines may not apply in all situations. Electromagnetic propagation is affected by absorption and reflection from structures, objects and people.

^a Field strengths from fixed transmitters, such as base stations for radio (cellular/cordless) telephones and land mobile radios, amateur radio, AM and FM radio broadcast and TV broadcast cannot be predicted theoretically with accuracy. To assess the electromagnetic environment due to fixed RF transmitters, an electromagnetic site survey should be considered. If the measured field strength in the location in which the RadiForce series is used exceeds the applicable RF compliance level above, the RadiForce series should be observed to verify normal operation. If abnormal performance is observed, additional measures may be necessary, such as reorienting or relocating the RadiForce series.

^b Over the frequency range 150 kHz to 80 MHz, field strengths should be less than 3 V/m.

Recommended separation distances between portable and mobile RF communications equipment and the RadiForce Series

The RadiForce series is intended for use in an electromagnetic environment in which radiated RF disturbances are controlled. The customer or the user of the RadiForce series can help prevent electromagnetic interference by maintaining a minimum distance between portable and mobile RF communications equipment (transmitters) and the RadiForce series as recommended below, according to the maximum output power of the communications equipment.

Rated maximum output power of transmitter W	Separation distance according to frequency of transmitter m		
	150kHz to 80MHz $d = 1.2 \sqrt{P}$	80MHz to 800MHz $d = 1.2 \sqrt{P}$	800MHz to 2.5GHz $d = 2.3 \sqrt{P}$
0.01	0.12	0.12	0.23
0.1	0.38	0.38	0.73
1	1.2	1.2	2.3
10	3.8	3.8	7.3
100	12	12	23

For transmitters rated at a maximum output power not listed above, the recommended separation distance “d” in meters (m) can be estimated using the equation applicable to the frequency of the transmitter, where “P” is the maximum output power rating of the transmitter in watts (W) according to the transmitter manufacturer.

NOTE 1 At 80 MHz and 800 MHz, the separation distance for the higher frequency range applies.

NOTE 2 These guidelines may not apply in all situations. Electromagnetic propagation is affected by absorption and reflection from structures, objects and people.

Recycling Information/Informationen zum Thema Recycling/ Informations sur le recyclage/Информация относительно рециклиране

Recycling Information

This product, when disposed of, is supposed to be collected and recycled according to your country's legislation to reduce environmental burden. When you dispose of this product, please contact a distributor or an affiliate in your country.

The contact addressees are listed on the EIZO website below.

<http://www.eizoglobal.com>

For recycling information for customers in Switzerland, please refer to the following website.

<http://www.swico.ch>

Informationen zum Thema Recycling

Dieses Produkt muss gemäß den Vorschriften Ihres Landes zur Entlastung der Umwelt recyclet werden. Wenden Sie sich bei der Entsorgung dieses Produkts an einen Verteiler oder eine Tochtergesellschaft in Ihrem Land.

Die Adressen zur Kontaktaufnahme sind auf der unten angegebenen Website von EIZO aufgeführt.

<http://www.eizoglobal.com>

Kunden in der Schweiz entnehmen Informationen zum Recycling der folgenden Website:

<http://www.swico.ch>

Informations sur le recyclage

Ce produit doit être jeté aux points de collecte prévus à cet effet et recyclé conformément à la législation de votre pays, afin de réduire l'impact sur l'environnement. Lorsque vous jetez ce produit, veuillez contacter un distributeur ou une société affiliée de votre pays.

Les adresses des distributeurs sont répertoriées sur le site Web EIZO ci-dessous.

<http://www.eizoglobal.com>

Pour les clients en Suisse, veuillez consulter le site Web suivant afin d'obtenir des informations sur le recyclage.

<http://www.swico.ch>

Información sobre reciclaje

Este producto debe desecharse y reciclarse según la legislación del país para reducir el impacto medioambiental. Cuando desee deshacerse de este producto, póngase en contacto con un distribuidor o una filial de su país.

Encontrará las direcciones de contacto en el sitio web de EIZO que se indica a continuación.

<http://www.eizoglobal.com>

Informazioni sul riciclaggio

Per lo smaltimento e il riciclaggio del presente prodotto, attenersi alle normative vigenti nel proprio paese per ridurre l'impatto ambientale. Per lo smaltimento, rivolgersi ad un distributore o un affiliato presenti nel proprio paese.

Gli indirizzi sono elencati nel sito Web EIZO riportato di seguito.

<http://www.eizoglobal.com>

Per informazioni sul riciclaggio per i clienti in Svizzera, consultare il sito Web riportato di seguito.

<http://www.swico.ch>

Återvinningsinformation

När denna produkt kasseras ska den hanteras och återvinnas enligt landets föreskrifter för att reducera miljöpåverkan. När du kasserar produkten ska du kontakta en distributör eller representant i ditt land.

Kontaktadresserna listas på EIZO-webbplatsen nedan.

<http://www.eizoglobal.com>

Πληροφορίες ανακύκλωσης

Το προϊόν αυτό, όταν απορρίπτεται, πρέπει να συλλέγεται και να ανακυκλώνεται σύμφωνα με τη νομοθεσία της χώρας σας έτσι ώστε να μην επιβαρύνει το περιβάλλον. Για να απορρίψετε το προϊόν, επικοινωνήστε με έναν αντιπρόσωπο ή μια θυγατρική εταιρεία στη χώρα σας.

Οι διευθύνσεις επικοινωνίας αναγράφονται στην τοποθεσία web της EIZO παρακάτω.

<http://www.eizoglobal.com>

Сведения по утилизации

По истечении срока службы данного продукта его следует принести на сборный пункт и утилизировать в соответствии с действующими предписаниями в вашей стране, чтобы уменьшить вредное воздействие на окружающую среду. Прежде чем выбросить данный продукт, обратитесь к дистрибьютору или в местное представительство компании в вашей стране.

Контактные адреса можно найти на веб-узле EIZO.

<http://www.eizoglobal.com>

Informatie over recycling

Wanneer u dit product wilt weggooien, moet het uit milieu-overwegingen worden verzameld en gerecycled volgens de betreffende wetgeving van uw land. Wanneer u dit product wilt weggooien, moet u contact opnemen met een distributeur of een partner in uw land.

De contactadressen worden vermeld op de volgende EIZO-website.

<http://www.eizoglobal.com>

Informação sobre reciclagem

Este produto, quando o deitar fora, deve ser recolhido e reciclado de acordo com a legislação do seu país para reduzir a poluição. Quando deitar fora este produto, contacte um distribuidor ou uma filial no seu país.

Os endereços de contacto estão listados no website do EIZO, abaixo.

<http://www.eizoglobal.com>

Oplysninger om genbrug

Dette produkt forventes ved bortskaffelse at blive indsamlet og genbrugt i overensstemmelse med lovgivningen i dit land for at reducere belastningen af miljøet. Når du bortskaffer denne produkt, skal du kontakte en distributør eller et tilknyttet selskab i dit land.

Adresserne på kontaktpersonerne er angivet på EIZO's websted nedenfor.

<http://www.eizoglobal.com>

Kierrätystä koskevia tietoja

Tuote tulee hävittää kierrättämällä maan lainsäädännön mukaisesti ympäristön kuormittumisen vähentämiseksi. Kun hävität tuotteen, ota yhteyttä jälleenmyyjään tai tytäryhtiöön maassasi.

Yhteystiedot löytyvät EIZOn Internet-sivustolta.

<http://www.eizoglobal.com>

Wykorzystanie surowców wtórnych

Ten produkt po zużyciu powinien być zbierany i przetwarzany zgodnie z krajowymi przepisami dotyczącymi ochrony środowiska. Wyrzucając ten produkt, należy skontaktować się z lokalnym dystrybutorem lub partnerem. Adresy kontaktowe można znaleźć we wskazanej poniżej witrynie internetowej firmy EIZO.

<http://www.eizoglobal.com>

Informace o recyklaci

Při likvidaci produktu musí být produkt vyzvednut a recyklován podle zákonů příslušné země, aby nedocházelo k zatěžování životního prostředí. Zbavujete-li se produktu, kontaktujte distributora nebo pobočku ve své zemi. Kontaktní adresy jsou uvedeny na následující webové stránce společnosti EIZO.
<http://www.eizoglobal.com>

Ringlussevõtu alane teave

Keskkonnakoormuse vähendamiseks tuleks kasutatud tooted kokku koguda ja võtta ringlusse vastavalt teie riigi seadustele. Kui kõrvaldate käesoleva toote, võtke palun ühendust turustaja või filiaaliga oma riigis. Kontaktisikud on toodud EIZO veebilehel järgmisel aadressil:
<http://www.eizoglobal.com>

Újrahasznosítási információ

Jelen terméket, amikor eldobjuk, az illető ország törvényei alapján kell összegyűjteni és újrahasznosítani, hogy csökkentsük a környezet terhelését. Amikor ezt a terméket eldobja, kérjük lépjen kapcsolatba egy országon belüli forgalmazóval vagy társvállalkozással.
A kapcsolat címei az EIZO alábbi weboldalán találhatók felsorolva:
<http://www.eizoglobal.com>

Podatki o recikliranju

Ob koncu uporabe odslužen izdelek izročite na zbirno mesto za recikliranje v skladu z okoljevarstveno zakonodajo vaše države. Prosimo, da se pri odstranjevanju izdelka obrnete na lokalnega distributerja ali podružnico.
Kontaktne naslovi so objavljeni na spodaj navedenih spletnih straneh EIZO:
<http://www.eizoglobal.com>

Informácie o recyklácii

Pri likvidácii musí byť tento výrobok recyklovaný v súlade s legislatívou vašej krajiny, aby sa znížilo zaťaženie životného prostredia. Keď sa chcete zbaviť tohto výrobku, kontaktujte prosím distribútora alebo pobočku vo vašej krajine.
Zoznam kontaktných adries je uvedený na nasledovnej webovej stránke firmy EIZO:
<http://www.eizoglobal.com>

Pārstrādes informācija

Utilizējot šo produktu, tā savākšana un pārstrāde veicama atbilstoši jūsu valsts likumdošanas prasībām attiecībā uz slodzes uz vidi samazināšanu. Lai veiktu šī produkta utilizāciju, sazinieties ar izplatītāju vai pārstāvniecību jūsu valstī.
Kontaktadrese ir norādītas zemāk minētajā EIZO tīmekļa vietnē.
<http://www.eizoglobal.com>

Informacja apie gražinamąjį perdirbimą

Šalinant (išmetant) šiuos gaminius juos reikia surinkti ir perdirbti gražinamuoju būdu pagal jūsų šalies teisės aktus, siekiant sumažinti aplinkos teršimą. Kai reikia išmesti šį gaminį, kreipkitės į jūsų šalyje veikiančią gaminių pardavimo atstovybę arba jos filialą.
Kontaktiniai adresatai nurodyti EIZO interneto svetainėje.
<http://www.eizoglobal.com>

Информация относно рециклиране

При изхвърлянето на този продукт се предлага събирането и рециклирането му съобразно законите на вашата страна за да се намали замърсяването на околната среда. Когато искате да се освободите от този продукт, моля свържете се с търговския му представител или със съответните органи отговарящи за това във вашата страна.

Данните за връзка с нас са описани на следния Интернет сайт на EIZO:
<http://www.eizoglobal.com>

Informație referitoare la reciclare

Acest produs, când debarasat, trebuie colectat și reciclat conform legislației țării respective ca să reducem sarcina mediului. Când se debarasează de acest produs, vă rugăm să contactați un distribuitor sau un afiliat al țării respective.

Adresele de contact le găsiți pe pagina de web al EIZO:
<http://www.eizoglobal.com>

معلومات عن إعادة التدوير

عند التخلص من هذا المنتج، من الضروري تجميعه وإعادة تدويره وفقاً للقوانين المتبعة في بلدك لتقليل العبء المسلط على البيئة. عندما تتخلص من هذا المنتج، يرجى الاتصال بموزع أو طرف متناسب إليه في بلدك. عناوين الاتصال مدرجة في موقع ايزو EIZO ادناه على شبكة الانترنت.
<http://www.eizoglobal.com>

Geri Dönüşüm Bilgisi

Bu ürünün, atılacağı zaman, ülkenizin çevre kirliliğinin azaltılması konusundaki mevzuatına göre toplanması ve yeniden değerlendirilmesi gerekmektedir. Ürünü atacağınız zaman lütfen ülkenizdeki bir distribütör veya ilgili kuruluşla temasa geçiniz.

İrtibat adresleri aşağıdaki EIZO web sitesinde verilmiştir.
<http://www.eizoglobal.com>



EIZO Corporation

153 Shimokashiwano, Hakusan, Ishikawa 924-8566 Japan

艺卓显像技术(苏州)有限公司

中国苏州市苏州工业园区展业路 8 号中新科技工业坊 5B

EC REP



EIZO GmbH

Siemensallee 84, 76187 Karlsruhe, Germany

<http://www.eizoglobal.com>

Copyright © 2016-2018 EIZO Corporation. All rights reserved.



00N0L956B1 
IFU-GX550-5 

2nd Edition-May, 2018 Printed in Japan.