

# OUTLINE DIMENSIONS

MODEL EV2485

UNIT mm

**EIZO Corporation**

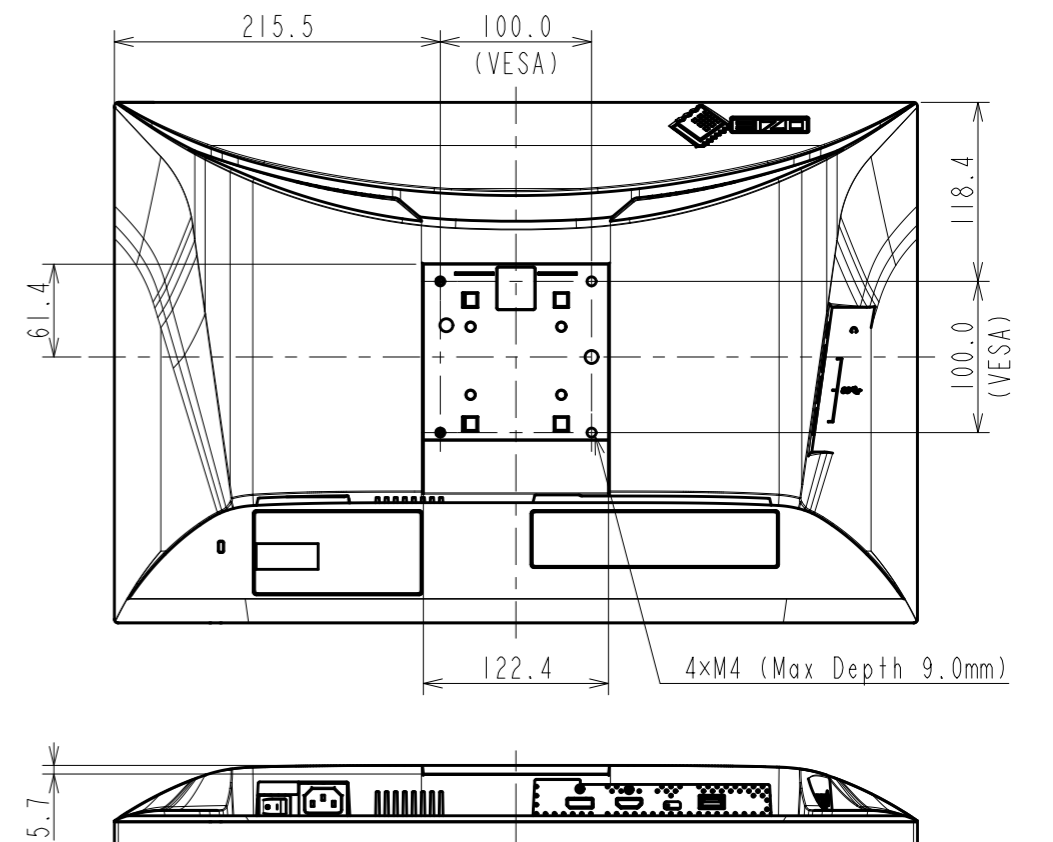
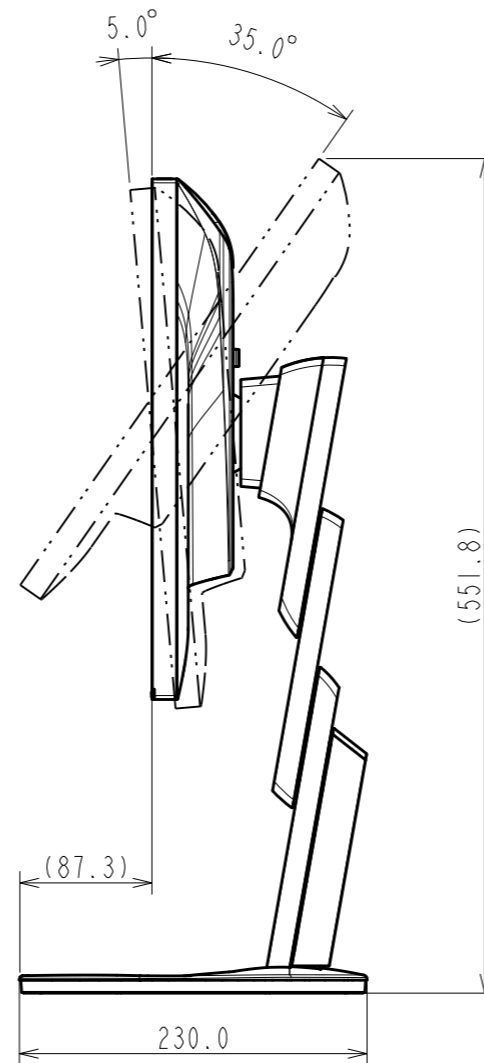
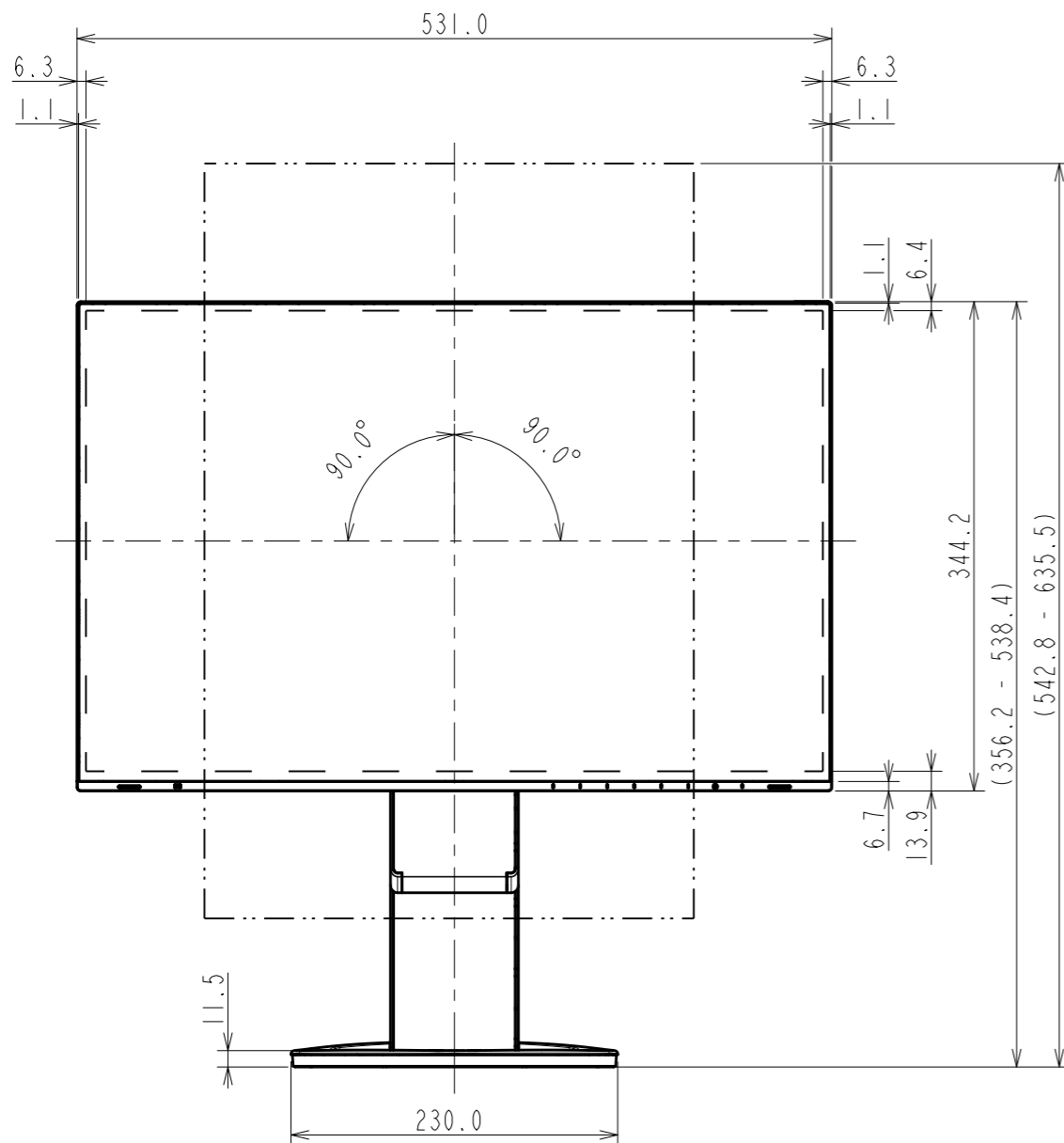
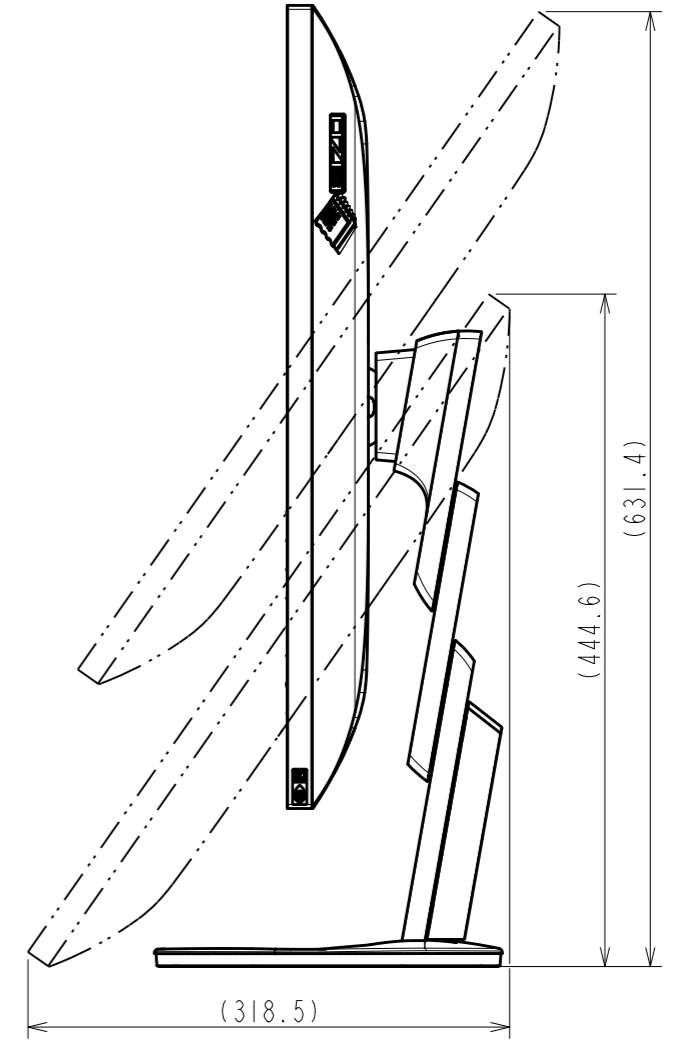
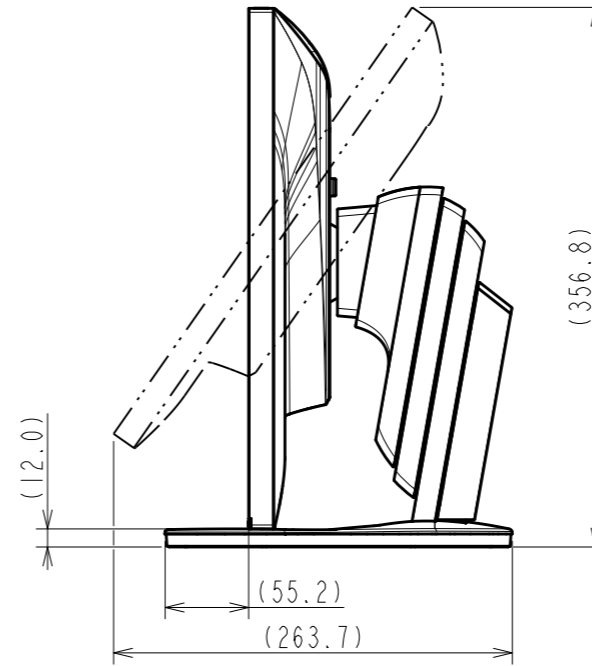
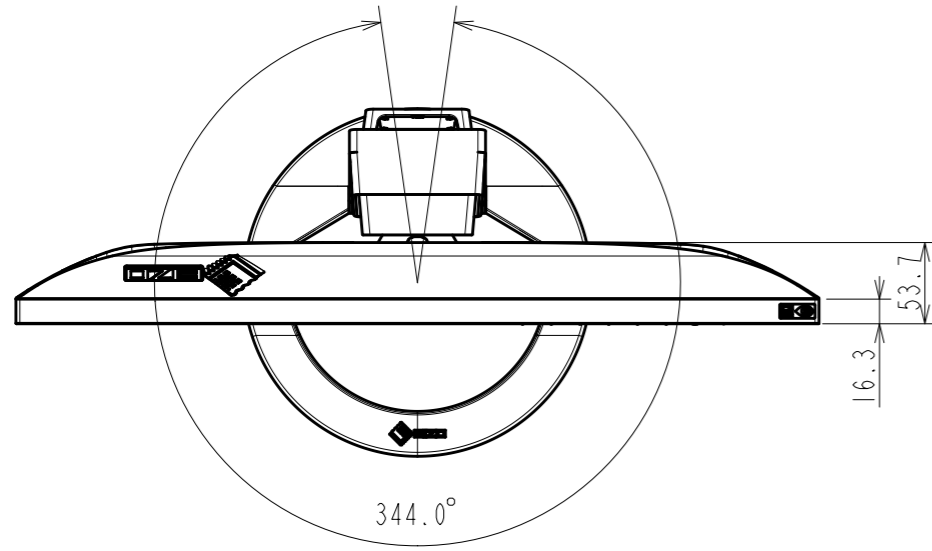

# OUTLINE DIMENSIONS

MODEL EV2485

UNIT mm

**EIZO Corporation**

